

LECROY

X-STREAM OSCILLOSCOPES

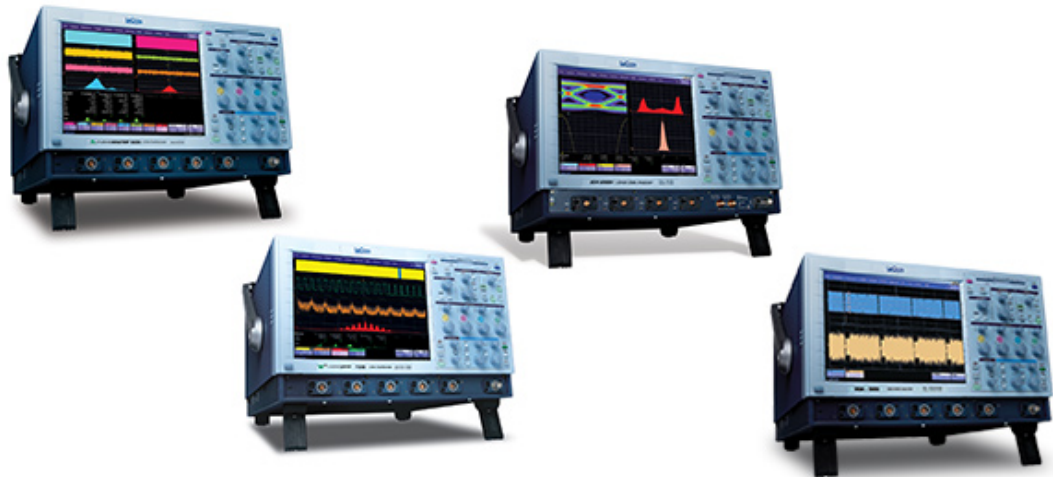

OPERATOR'S MANUAL

FEBRUARY 2007

LeCroy Corporation

700 Chestnut Ridge Road
Chestnut Ridge, NY 10977-6499
Tel: (845) 578 6020, Fax: (845) 578 5985

Internet: www.lecroy.com

© 2007 by LeCroy Corporation. All rights reserved.

LeCroy, ActiveDSO, WaveLink, JitterTrack, WavePro, WaveMaster, WaveSurfer, WaveExpert, WaveJet, and Waverunner are registered trademarks of LeCroy Corporation. Other product or brand names are trademarks or requested trademarks of their respective holders. Information in this publication supersedes all earlier versions. Specifications subject to change without notice.

<p>Manufactured under an ISO 9000 Registered Quality Management System Visit www.lecroy.com to view the certificate.</p>		<p>This electronic product is subject to disposal and recycling regulations that vary by country and region. Many countries prohibit the disposal of waste electronic equipment in standard waste receptacles.</p> <p>For more information about proper disposal and recycling of your LeCroy product, please visit www.lecroy.com/recycle.</p>
--	--	---

WM-OM-E Rev K
914861-00 Rev A

部件名称	有毒有害物质和元素					
	铅 (Pb)	汞 (Hg)	镉 (Cd)	六价铬 (Cr ⁶⁺)	多溴联苯 (PBB)	多溴二苯醚 (PBDE)
PCBAs	X	O	X	X	X	X
机械硬件	O	O	X	O	O	O
金属片	O	O	X	O	O	O
塑料部件	O	O	O	O	X	X
电缆组件	X	O	X	O	X	X
显示器	X	O	X	X	X	X
电源	X	X	X	O	X	X
风扇	X	O	X	O	X	X
处理器电源	X	O	X	O	O	O
电源线	X	O	X	O	X	X
外部电源(如有)	X	X	X	O	X	X
探头(如有)	X	O	X	O	X	X
光驱(如有)	X	O	X	O	X	X
熔丝(如有)	X	O	X	O	O	O
产品外壳(如有)	O	O	O	O	X	X
适配器 模块(如有)	X	O	O	O	O	O
鼠标(如有)	X	O	X	O	X	X
O: 表明该有毒有害物质在该部件所有均质材料中的含量均在 SJ/T11363-2006 标准规定的限量要求之下。						
X: 表明该有毒有害物质至少在该部件的某一均质材料中的含量超过 SJ/T11363-2006 标准规定的限量要求。						

EFUP (对环境友好的使用时间) 使用条件: 参阅本手册“规范”部分规定的环境条件。

电池 EFUP: 5 年

Part Name	Toxic or Hazardous Substances and Elements					
	Lead (Pb)	Mercury (Hg)	Cadmium (Cd)	Hexavalent Chromium (Cr ⁶⁺)	Polybrominated Biphenyls (PBB)	Polybrominated Diphenyl Ethers (PBDE)
PCBAs	X	O	X	X	X	X
Mechanical Hardware	O	O	X	O	O	O
Sheet Metal	O	O	X	O	O	O
Plastic Parts	O	O	O	O	X	X
Cable Assemblies	X	O	X	O	X	X
Display	X	O	X	X	X	X
Power Supply	X	X	X	O	X	X
Fans	X	O	X	O	X	X
Battery for Processor	X	O	X	O	O	O
Power Cord	X	O	X	O	X	X
Ext Power Supply (if present)	X	X	X	O	X	X
Probes (if present)	X	O	X	O	X	X
CD Drive (if present)	X	O	X	O	X	X
Fuse (if present)	X	O	X	O	O	O
Product Case (if present)	O	O	O	O	X	X
Adapters/Modules (if present)	X	O	O	O	O	O
Mouse (if present)	X	O	X	O	X	X
O: Indicates that this toxic or hazardous substance contained in all of the homogeneous materials for this part is below the limit requirement specified in SJ/T11363-2006.						
X: Indicates that this toxic or hazardous substance contained in at least one of the homogenous materials used for this part is above the limit requirement specified in SJ/T11363-2006.						

EFUP (Environmental Friendly Use Period) Use Conditions: Refer to the environmental conditions stated in the Specifications section of this manual.

EFUP for Battery: 5 Years

INTRODUCTION	17
How to Use On-line Help	17
Type Styles	17
Instrument Help.....	17
Windows Help.....	18
Returning a Product for Service or Repair.....	18
Technical Support.....	18
Staying Up-to-Date	18
Windows License Agreement	19
End-user License Agreement For LeCroy® X-Stream Software	19
Virus Protection	25
Warranty	25
Specifications.....	26
Vertical System.....	26
 Max Input Voltage	27
Horizontal System.....	27
Acquisition System.....	28
Acquisition Modes.....	29
Acquisition Processing.....	29
Triggering System.....	29
Basic Triggers	30
SMART Triggers	30
SMART Triggers with Exclusion Technology.....	30
Automatic Setup.....	30
Probes.....	30
Color Waveform Display	31
Analog Persistence Display	31
Zoom Expansion Traces	31
Rapid Signal Processing.....	31
Internal Waveform Memory.....	31
Setup Storage	31
Interface	32
Auxiliary Output.....	32
Auxiliary Input	32
Math Tools (standard).....	32
Measure Tools (standard).....	33

Standard Jitter and Timing Measurements.....	33
Pass/Fail Testing	33
Master Analysis Package (XMAP).....	34
Jitter and Timing Analysis Package (JTA2).....	34
Disk Drive Measurement Package (DDM2).....	34
General	35
Warranty and Service	36
Environmental Characteristics	36
Certifications	36
CE Declaration of Conformity	36
Warranty	38
Windows License Agreement.....	38
End-User License Agreement For LeCroy X-Stream Software	38
Virus Protection	44
 SAFETY	45
Safety Requirements.....	45
Safety Symbols	45
Operating Environment	46
Cooling	47
AC Power Source.....	47
Power and Ground Connections	48
Standby (Power) Switch and Scope Operational States	48
Fuse Replacement	49
Calibration	49
Cleaning	49
Abnormal Conditions	50
BASIC CONTROLS	51
Front Panel Controls	51
Trigger Knobs:	52
Trigger Buttons:	52
Horizontal Knobs:.....	52
Horizontal Buttons:.....	52
Vertical Knobs:.....	52
Channel Buttons:	53
Wavepilot Control Knobs:	53
Wavepilot Control Buttons:	53

Measure	53
Analysis.....	53
Special Features Buttons:.....	53
General Control Buttons:	54
STANDBY Lamp:	54
On-screen Toolbars, Icons, and Dialog Boxes	55
Menu Bar Buttons	55
Dialog Boxes.....	57
Alternate Access Methods	57
Mouse and Keyboard Operation.....	57
Tool Bar Buttons	57
Trace Descriptors	58
Trace Annotation.....	59
Screen Layout.....	60
Menu Bar	61
Signal Display Grid	61
Dialog Area	61
INSTALLATION	64
Hardware	64
Instrument Rear Panel.....	64
Software.....	64
Checking the Scope Status	64
Loading Software Upgrades	65
Default Settings	65
WaveMaster and WavePro 7000A Series Scopes	65
DDAScopes	66
Adding a New Option.....	66
RESTORING SOFTWARE	68
Using the Recovery Disk – non-Windows XP Scopes.....	68
System Recovery – Windows XP Scopes	68
Recovery Procedure	68
Windows Activation.....	72
Restarting the Application.....	74
Restarting the Operating System.....	74
Removable Hard Drive	75
External Monitor.....	76
Writable CD Drive option	77

CONNECTING TO A SIGNAL	81
ProLink Interface	81
Connecting the Adapters	82
ProBus Interface.....	82
AP-1M Hi-Z Adapter	83
Auxiliary Output Signals	83
To Set Up Auxiliary Output	84
SAMPLING MODES	85
To Select a Sampling Mode.....	85
Single-shot sampling mode	85
Basic Capture Technique.....	85
Sequence SAMPLING Mode Working With Segments	86
To Set Up Sequence Mode.....	87
Sequence Display Modes	88
To Display Individual Segments	89
To View Time Stamps.....	89
RIS Sampling Mode -- For Higher Sample Rates.....	90
Roll Mode	91
VERTICAL SETTINGS AND CHANNEL CONTROLS	92
Adjusting Sensitivity and Position.....	92
To Adjust Sensitivity.....	92
To Adjust the Waveform's Position	92
Coupling	92
Overload Protection	92
To Set Coupling	92
Probe Attenuation.....	93
To Set Probe Attenuation.....	93
Bandwidth Limit	93
To Set Bandwidth Limiting	93
Linear and (SinX)/X Interpolation	93
To Set Up Interpolation	93
Inverting Waveforms	94
QuickZoom	94
To Turn On a Zoom	94
Finding Scale.....	94
To Use Find Scale	94
Variable Gain.....	94

To Enable Variable Gain.....	94
Channel Deskew.....	94
To Set Up Channel Deskew	94
TIMEBASE AND ACQUISITION SYSTEM.....	95
Timebase Setup and Control.....	95
Autosetup	95
Dual Channel Acquisition.....	95
Combining of Channels.....	95
SDA 11000 DBI Controls	96
SMART Memory	96
To Set Up SMART Memory	97
TRIGGERING	98
Trigger Setup Considerations	98
Trigger Modes.....	98
Trigger Types.....	98
Determining Trigger Level, Slope, Source, and Coupling	99
Trigger Source	100
Level.....	100
Holdoff by Time or Events.....	101
Simple Triggers.....	102
Edge Trigger on Simple Signals	102
Control Edge Triggering.....	102
To Set Up an Edge Trigger	103
SMART Triggers	105
Width Trigger	105
Glitch Trigger	106
Interval Trigger	108
Qualified Trigger	112
State Trigger	115
Dropout Trigger.....	116
Logic Trigger	117
Serial Trigger	119
Aux Input Trigger	119
To Set Up Aux Input.....	119
DISPLAY FORMATS	120
Display Setup.....	120
Sequence Mode Display	120

Persistence Setup	121
Saturation Level	121
3-Dimensional Persistence	122
Show Last Trace	123
Persistence Time	124
Locking of Traces.....	124
To Set Up Persistence	124
Screen Saver.....	125
Moving Traces from Grid to Grid	125
To Move a Channel or Math Trace	125
Zooming Waveforms	126
To Zoom a Single Channel	126
To Zoom by Touch-and-Drag.....	127
To Zoom Multiple Waveforms Quickly	128
Multi-Zoom	128
XY Display	129
To Set Up XY Displays	129
SAVE AND RECALL	131
Saving and Recalling Scope Settings.....	131
To Save Scope Settings	131
To Recall Scope Settings.....	131
To Recall Default Settings	131
Saving Screen Images	132
Saving and Recalling Waveforms.....	132
Saving Waveforms.....	132
Recalling Waveforms	134
Disk Utilities	134
To Delete a Single File.....	134
To Delete All Files in a Folder.....	135
To Create a Folder	135
PRINTING AND FILE MANAGEMENT	136
Print, Plot, or Copy	136
Printing	136
To Set Up the Printer	136
To Print.....	136
Adding Printers and Drivers	136
Changing the Default Printer.....	137

Managing Files	137
Hard Disk Partitions	137
100BASE-T ETHERNET CONNECTION.....	138
Connecting to a Network	138
Communicating over the Network.....	138
Windows Setups	138
System Restore	139
TRACK VIEWS	140
Creating and Viewing a Trend	140
Creating a Track View	140
HISTOGRAMS.....	142
Creating and Viewing a Histogram	142
To Set Up a Single Parameter Histogram	142
To View Thumbnail Histograms.....	143
Persistence Histogram.....	143
Persistence Trace Range	144
Persistence Sigma	144
Histogram Parameters.....	145
Histogram Theory of Operation	158
Scope Process.....	159
Parameter Buffer.....	160
Capture of Parameter Events	160
Histogram Parameters (XMAP and JTA2 Options)	161
Histogram Peaks	162
Binning and Measurement Accuracy	163
WAVEFORM MEASUREMENTS.....	164
Measuring with Cursors	164
Cursor Measurement Icons	164
Cursors Setup.....	164
Quick Display	164
Full Setup.....	165
Overview of Parameters	165
To Turn On Parameters.....	165
Quick Access to Parameter Setup Dialogs.....	165
Status Symbols	166
Using X-Stream Browser to Obtain Status Information	167
Statistics	169

To Apply a Measure Mode	169
Measure Modes.....	169
Standard Vertical Parameters.....	169
Standard Horizontal Parameters	170
My Measure	170
Parameter Math (XMath or XMAP option required).....	170
Logarithmic Parameters.....	170
Excluded Parameters.....	171
Parameter Script Parameter Math	171
Param Script vs. P Script.....	172
To Set Up Parameter Math	173
To Set Up Parameter Script Math.....	173
Measure Gate.....	174
To Set Up Measure Gate.....	175
Help Markers	176
To Set Up Help Markers	177
To Turn Off Help Markers	178
To Customize a Parameter.....	179
From the Measure Dialog	179
From a Vertical Setup Dialog.....	179
From a Math Setup Dialog.....	179
Parameter Calculations	180
Parameters and How They Work.....	180
Determining Time Parameters.....	181
Determining Differential Time Measurements	182
Level and Slope	183
List of Parameters	184
Qualified Parameters.....	211
Range Limited Parameters	211
Waveform Gated Parameters.....	213
To Set Up Waveform Qualifiers	213
WAVEFORM MATH	214
Introduction to Math Traces and Functions	214
Math Made Easy	214
To Set Up a Math Function.....	214
Resampling To Deskew	215
To Resample.....	215

Rescaling and Assigning Units	216
To Set Up Rescaling	216
Averaging Waveforms	216
Summed vs. Continuous Averaging	216
To Set Up Continuous Averaging	218
To Set Up Summed Averaging	218
Enhanced Resolution.....	218
How the Instrument Enhances Resolution.....	218
To Set Up Enhanced Resolution (ERES)	221
Waveform Copy	221
Waveform Sparser.....	221
To Set Up Waveform Sparser.....	222
Interpolation	222
To Set Up Interpolation	222
Fast Wave Port.....	223
Fast Wave Port Setup -- Initial.....	223
Setup -- Case 1.....	224
Setup -- Case 2.....	224
Setup -- Case 3.....	224
Operational Notes	225
Example Applications	225
Header Description	229
Data Length Limitations	229
Performance	230
Choice of Programming Language	230
Demodulation.....	230
Theory of Operation	231
To Set Up Demodulation.....	231
FFT	232
Why Use FFT?.....	232
Improving Dynamic Range	235
Record Length	235
FFT Algorithms	235
Glossary.....	237
FFT Setup	240
ANALYSIS	242
Pass/Fail Testing	242

Comparing Parameters.....	242
Mask Tests.....	242
Actions	243
Setting Up Pass/Fail Testing	243
Initial Setup	243
Comparing a Single Parameter.....	244
Comparing Dual Parameters	245
Mask Testing.....	246
UTILITIES	248
Status	248
To Access Status Dialog.....	248
Remote communication.....	248
To Set Up Remote Communication.....	248
To Configure the Remote Control Assistant Event Log.....	248
Hardcopy	249
Printing.....	249
Clipboard.....	249
File	249
E-Mail.....	250
Aux Output	250
Date & Time	250
To Set Time and Date Manually	250
To Set Time and Date from the Internet	250
To Set Time and Date from Windows.....	251
Options	252
Preferences	252
Audible Feedback	252
Auto-calibration	252
Offset Control.....	252
Delay Control	252
Trigger Counter.....	253
Performance Optimization	253
E-mail.....	253
Acquisition Status.....	254
Service	254
Show Windows Desktop.....	254
Touch Screen Calibration.....	255

CUSTOMIZATION	256
Customizing Your Instrument	256
Introduction	256
Solutions	256
Examples	257
What is Excel?	262
What is Mathcad?	262
What is MATLAB?	262
What is VBS?	262
What can you do with a customized instrument?	264
Number of Samples	265
Calling Excel From Your Instrument	265
Calling Excel Directly from the Instrument	265
How to Select a Math Function Call	265
How to Select a Parameter Function Call	266
The Excel Control Dialog	266
Entering a File Name	266
Organizing Excel sheets	267
Scale Setting the Vertical Scale	267
Trace Descriptors	268
Multiple Inputs and Outputs	268
Simple Excel Example 2	271
Exponential Decay Time Constant Excel Parameter (Excel Example 1)	275
Gated Parameter Using Excel (Excel Example 2)	278
How Does this Work?	279
Correlation Excel Waveform Function (Excel Example 3)	279
Multiple Traces on One Grid (Excel Example 4)	281
Using a Surface Plot (Excel Example 5)	285
Writing VB Scripts	286
Types of Scripts in VBS	286
Loading and Saving VBScripts	286
The default parameter function script: explanatory notes	290
Scripting with VBScript	291
Variable Types	291
Variable Names	292
General usage	292
Arithmetic Operators	293

Results of Calculations	293
Order of Calculations	294
VBS Controls	294
IF . . . Then . . . Else . . . End If	295
Summary of If . . . Then . . . Else	297
Select Case	297
Summary of Select Case . . . End Select	298
Do . . . Loop	298
While . . . Wend	299
For . . . Next	299
VBS Keywords and Functions	301
Other VBS Words	302
Functions	303
Hints and Tips for VBScripting	304
Errors	305
Error Handling	307
Speed of Execution	307
Scripting Ideas	308
Debugging Scripts	309
Horizontal Control Variables	309
Vertical Control Variables	309
List of Variables Available to Scripts	310
Communicating with Other Programs from a VBScript	311
Communicating with Excel from a VBScript	311
Calling MATLAB from the Instrument	313
Calling MATLAB	313
How to Select a Waveform Function Call	313
The MATLAB Waveform Control Panel	314
MATLAB Waveform Function Editor -- Example	314
MATLAB Example Waveform Plot	317
How to Select a MATLAB Parameter Call	318
The MATLAB Parameter Control Panel	318
The MATLAB Parameter Editor	319
MATLAB Example Parameter Panel	320
Further Examples of MATLAB Waveform Functions	321
Creating your own MATLAB function	323

CUSTOMDSO	325
Custom DSO.....	325
Introduction - What is CustomDSO?.....	325
Invoking CustomDSO	325
CustomDSO Basic Mode.....	326
Editing a CustomDSO Setup File	326
Creating a CustomDSO Setup File.....	328
CustomDSO PlugIn Mode	328
Creating a CustomDSO PlugIn.....	328
Properties of the Control and its Objects	330
Removing a PlugIn.....	333
First Example PlugIn - Exchanging Two Traces on the Grids	333
Second Example PlugIn - Log-Log FFT Plot	336
Control Variables in CustomDSO	338
LABNOTEBOOK	339
Introduction to LabNotebook.....	339
Preferences.....	339
Miscellaneous Settings	339
Hardcopy Setup	339
E-mail Setup	340
Creating a Notebook Entry.....	340
Recalling Notebook Entries	343
Creating a Report.....	344
Previewing a Report.....	344
Locating a Notebook Entry	344
Creating the Report.....	345
Formatting the Report.....	346
Managing Notebook Entry Data.....	347
Adding Annotations.....	347
Deleting Notebook Entries	347
Saving Notebook Entries to a Folder	347
Managing the Database.....	347
To Start a New Database.....	348
DDA	349
DDA Front Panel Controls	349
DDA Specifications	349
Additional DDA Triggers	349

Disk Drive Measurement Package (DDM2).....	349
Automated DDA Measurements	350
Advanced DDA Analysis	351
Drive Analysis Overview.....	351
Obstacles that Can Be Overcome Using the DDA's Channel Analysis.....	351
What Channel Analysis Provides.....	352
Channel Emulation.....	352
With or Without Reference.....	353
Stop On SAM	354
Analog Compare	354
Measure's Drive Parameters	356
Setting Up Channel Emulation	356
Drive Analysis Setup.....	356
Channel Setup	358
Setting Up Analog Compare.....	360
Drive Analysis Setup.....	360
Channel Setup	361
Setting Up Noise Analysis	361
Setting Up Disk Triggers	363
Read Gate.....	363
Sector Pulse.....	363
Servo Gate.....	364
Setting Up Zoom	365
DDA REFERENCE INFORMATION.....	366
Channel Analysis Concepts.....	366
Using the DDA's Equalization Filter	366
Selecting the Waveform Section to Be Analyzed	367
DDA Markers	369
Setting Up to Use Drive Channel Analysis	369
Which Signals to Provide.....	369
Choosing the Waveform Section to Be Analyzed.....	369
Selecting the Reference Waveform	370
Time/Div Settings.....	371
Automatically Shown Traces.....	372
Setting Bit Cell Time	372
Retraining the Filter.....	372
Choosing an Analysis Method.....	372

Analog Compare	373
Channel Emulation without Reference	373
Channel Emulation with Reference	373
Channel Emulation without Reference	374
Notes on Using Channel Emulation without Reference.....	376
Channel Emulation with Reference	377
Notes on Using Channel Emulation with Reference.....	379
Using Analog Compare.....	380
Notes on Using Head/Analog Compare.....	381
Local Feature Concepts.....	382
Overview	382
Peak-Trough Identification.....	383
Local Baselines.....	383
Setting Hysteresis.....	385
Local Parameters.....	385
Local Feature Parameters	387
Disk Standard Parameters.....	402
Disk PRML Parameters	410
Noise Parameters	419
PRML Channel Emulation	422
Why PRML?	422
Principle of Equalization.....	423
-3 dB Frequency	424
Boost at f_c	424
Group Delay	425
Resampling ADC	426
Finite Impulse Response (FIR).....	426
Phase Locked Loop (PLL)	426
Automatic Gain Control (AGC)	427
PLL and AGC	428
ML Detector	428
Viterbi Detector & Trellis	428
SAM	428
Encoding	429
Error Correction	429
User Defined Trellis	429
File Format and Language (version 1).....	429

Loading Your UDT File Remotely	430
Example File	436

INTRODUCTION

How to Use On-line Help

Type Styles

Activators of pop-up text and images appear as green, underlined, italic: *Pop-up*. To close pop-up text and images after opening them, touch the pop-up text again.

Link text appears blue and underlined: [Link](#). Links jump you to other topics, URLs, or images; or to

another location within the same Help window. After making a jump, you can touch the [Back](#)  icon in the toolbar at the top of the Help window to return to the Help screen you just left. With each touch of the **Back** icon, you return to the preceding Help screen.

Instrument Help



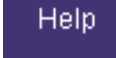

When you press the front panel Help button  (if available), or touch the on-screen **Help**

button , you will be presented with a menu: you can choose either to have information found for you automatically or to search for information yourself.

If you want context-sensitive Help, that is, Help related to what was displayed on the screen when

you requested Help, touch  in the drop-down menu, then touch the on-screen control (or front panel button or knob) that you need information about. The instrument will automatically display Help about that control.

If you want information about something not displayed on the screen, touch one of the buttons inside the drop-down menu to display the on-line Help manual:

 Contents...	Contents displays the Table of Contents.
 Index...	Index displays an alphabetical listing of keywords.
 Search...	Search locates every occurrence of the keyword that you enter.
 LeCroy.com...	www.LeCroy.com connects you to LeCroy's Web site where you can find Lab Briefs, Application Notes, and other useful information. This feature requires that the instrument be connected to the internet through the Ethernet port on the scope's rear panel. Refer to Remote Communication for setup instructions.

	About opens the Utilities "Status" dialog, which shows software version and other system information.
---	--

Once opened, the Help window will display its navigation pane: the part of the window that shows the Table of Contents and Index. When you touch anywhere outside of the Help window, this navigation pane will disappear to reveal more of your signal. To make it return, touch the Show



Show icon at the top of the Help window or touch inside the Help information pane.

Windows Help

In addition to instrument Help, you can also access on-line Help for Microsoft® Windows®. This help is accessible by minimizing the scope application, then touching the **Start** button in the Windows task bar at the bottom of the screen and selecting **Help**.

Returning a Product for Service or Repair

If you need to return a LeCroy product, identify it by its model and serial numbers. Describe the defect or failure, and give us your name and telephone number.

For factory returns, use a Return Authorization Number (RAN), which you can get from customer service. Write the number clearly on the outside of the shipping carton.

Return products requiring only maintenance to your local customer service center.

If you need to return your scope for any reason, use the original shipping carton. If this is not possible, be sure to use a rigid carton. The scope should be packed so that it is surrounded by a minimum of four inches (10 cm) of shock absorbent material.

Within the warranty period, transportation charges to the factory will be your responsibility. Products under warranty will be returned to you with transport prepaid by LeCroy. Outside the warranty period, you will have to provide us with a purchase order number before the work can be done. You will be billed for parts and labor related to the repair work, as well as for shipping.

You should prepay return shipments. LeCroy cannot accept COD (Cash On Delivery) or Collect Return shipments. We recommend using air freight.

Technical Support

You can get assistance with installation, calibration, and a full range of software applications from your customer service center. Visit the LeCroy Web site at <http://www.lecroy.com> for the center nearest you.

Staying Up-to-Date

To maintain your instrument's performance within specifications, have us calibrate it at least once a year. LeCroy offers state-of-the-art performance by continually refining and improving the instrument's capabilities and operation. We frequently update both firmware and software during service, free of charge during warranty.

You can also install new purchased software options in your scope yourself, without having to

return it to the factory. Simply provide us with your instrument serial number and ID, and the version number of instrument software installed. We will provide you with a unique option key that consists of a code to be entered through the Utilities' Options dialog to load the software option.

Windows License Agreement

LeCroy's agreement with Microsoft prohibits users from running software on LeCroy X-Stream oscilloscopes that is not relevant to measuring, analyzing, or documenting waveforms.

End-user License Agreement For LeCroy® X-Stream Software

IMPORTANT-READ CAREFULLY: THIS END-USER LICENSE AGREEMENT (“EULA”) IS A LEGAL AGREEMENT BETWEEN THE INDIVIDUAL OR ENTITY LICENSING THE SOFTWARE PRODUCT (“YOU” OR “YOUR”) AND LECROY CORPORATION (“LECROY”) FOR THE SOFTWARE PRODUCT(S) ACCOMPANYING THIS EULA, WHICH INCLUDE(S): COMPUTER PROGRAMS; ANY “ONLINE” OR ELECTRONIC DOCUMENTATION AND PRINTED MATERIALS PROVIDED BY LECROY HERewith (“DOCUMENTATION”); ASSOCIATED MEDIA; AND ANY UPDATES (AS DEFINED BELOW) (COLLECTIVELY, THE “SOFTWARE PRODUCT”). BY USING AN INSTRUMENT TOGETHER WITH OR CONTAINING THE SOFTWARE PRODUCT, OR BY INSTALLING, COPYING, OR OTHERWISE USING THE SOFTWARE PRODUCT, IN WHOLE OR IN PART, YOU AGREE TO BE BOUND BY THE TERMS OF THIS EULA. IF YOU DO NOT AGREE TO THE TERMS OF THIS EULA, DO NOT INSTALL, COPY, OR OTHERWISE USE THE SOFTWARE PRODUCT; YOU MAY RETURN THE SOFTWARE PRODUCT TO YOUR PLACE OF PURCHASE FOR A FULL REFUND. IN ADDITION, BY INSTALLING, COPYING, OR OTHERWISE USING ANY MODIFICATIONS, ENHANCEMENTS, NEW VERSIONS, BUG FIXES, OR OTHER COMPONENTS OF THE SOFTWARE PRODUCT THAT LECROY PROVIDES TO YOU SEPARATELY AS PART OF THE SOFTWARE PRODUCT (“UPDATES”), YOU AGREE TO BE BOUND BY ANY ADDITIONAL LICENSE TERMS THAT ACCOMPANY SUCH UPDATES. IF YOU DO NOT AGREE TO SUCH ADDITIONAL LICENSE TERMS, YOU MAY NOT INSTALL, COPY, OR OTHERWISE USE SUCH UPDATES.

THE PARTIES CONFIRM THAT THIS AGREEMENT AND ALL RELATED DOCUMENTATION ARE AND WILL BE DRAFTED IN ENGLISH. LES PARTIES AUX PRÉSENTÉS CONFIRMENT LEUR VOLONTÉ QUE CETTE CONVENTION DE MÊME QUE TOUS LES DOCUMENTS Y COMPRIS TOUT AVIS QUI S’Y RATTACHÉ, SOIENT REDIGÉS EN LANGUE ANGLAISE.

1. GRANT OF LICENSE.

1.1 License Grant. Subject to the terms and conditions of this EULA and payment of all applicable fees, LeCroy grants to you a nonexclusive, nontransferable license (the “License”) to: (a) operate the Software Product as provided or installed, in object code form, for your own internal business purposes, (i) for use in or with an instrument provided or manufactured by LeCroy (an “Instrument”), (ii) for testing your software product(s) (to be used solely by you) that are designed to operate in conjunction with an Instrument (“Your Software”), and (iii) make one copy for archival and back-up purposes; (b) make and use copies of the Documentation; provided that such copies will be used only in connection with your licensed use of the Software Product, and such copies may not be republished or distributed (either in hard copy or electronic form) to any third party; and (c) copy, modify, enhance and prepare derivative works (“Derivatives”) of the source code version of those portions of the Software Product set forth in and identified in the Documentation as “Samples”

(“Sample Code”) for the sole purposes of designing, developing, and testing Your Software. If you are an entity, only one designated individual within your organization, as designated by you, may exercise the License; provided that additional individuals within your organization may assist with respect to reproducing and distributing Sample Code as permitted under Section 1.1(c)(ii). LeCroy reserves all rights not expressly granted to you. No license is granted hereunder for any use other than that specified herein, and no license is granted for any use in combination or in connection with other products or services (other than Instruments and Your Software) without the express prior written consent of LeCroy. The Software Product is licensed as a single product. Its component parts may not be separated for use by more than one user. This EULA does not grant you any rights in connection with any trademarks or service marks of LeCroy. The Software Product is protected by copyright laws and international copyright treaties, as well as other intellectual property laws and treaties. The Software Product is licensed, not sold. The terms of this printed, paper EULA supersede the terms of any on-screen license agreement found within the Software Product.

1.2 Upgrades. If the Software Product is labeled as an “upgrade,” (or other similar designation) the License will not take effect, and you will have no right to use or access the Software Product unless you are properly licensed to use a product identified by LeCroy as being eligible for the upgrade (“Underlying Product”). A Software Product labeled as an “upgrade” replaces and/or supplements the Underlying Product. You may use the resulting upgraded product only in accordance with the terms of this EULA. If the Software Product is an upgrade of a component of a package of software programs that you licensed as a single product, the Software Product may be used and transferred only as part of that single product package and may not be separated for use on more than one computer.

1.3. Limitations. Except as specifically permitted in this EULA, you will not directly or indirectly (a) use any Confidential Information to create any software or documentation that is similar to any of the Software Product or Documentation; (b) encumber, transfer, rent, lease, time-share or use the Software Product in any service bureau arrangement; (c) copy (except for archival purposes), distribute, manufacture, adapt, create derivative works of, translate, localize, port or otherwise modify the Software Product or the Documentation; (d) permit access to the Software Product by any party developing, marketing or planning to develop or market any product having functionality similar to or competitive with the Software Product; (e) publish benchmark results relating to the Software Product, nor disclose Software Product features, errors or bugs to third parties; or (f) permit any third party to engage in any of the acts proscribed in clauses (a) through (e). In jurisdictions in which transfer is permitted, notwithstanding the foregoing prohibition, transfers will only be effective if you transfer a copy of this EULA, as well as all copies of the Software Product, whereupon your right to use the Software product will terminate. Except as described in this Section 1.3, You are not permitted (i) to decompile, disassemble, reverse compile, reverse assemble, reverse translate or otherwise reverse engineer the Software Product, (ii) to use any similar means to discover the source code of the Software Product or to discover the trade secrets in the Software Product, or (iii) to otherwise circumvent any technological measure that controls access to the Software Product. You may reverse engineer or otherwise circumvent the technological measures protecting the Software Product for the sole purpose of identifying and analyzing those elements that are necessary to achieve Interoperability (the “Permitted Objective”) only if: (A) doing so is necessary to achieve the Permitted Objective and it does not constitute infringement under Title 17 of the United States Code; (B) such circumvention is confined to those parts of the Software Product and to such acts as are necessary to achieve the Permitted

Objective; (C) the information to be gained thereby has not already been made readily available to you or has not been provided by LeCroy within a reasonable time after a written request by you to LeCroy to provide such information; (D) the information gained is not used for any purpose other than the Permitted Objective and is not disclosed to any other person except as may be necessary to achieve the Permitted Objective; and (E) the information obtained is not used (1) to create a computer program substantially similar in its expression to the Software Product including, but not limited to, expressions of the Software Product in other computer languages, or (2) for any other act restricted by LeCroy's intellectual property rights in the Software Product. "Interoperability" will have the same meaning in this EULA as defined in the Digital Millennium Copyright Act, 17 U.S.C. §1201(f), the ability of computer programs to exchange information and of such programs mutually to use the information which has been exchanged.

1.4 PRERELEASE CODE. Portions of the Software Product may be identified as prerelease code ("Prerelease Code"). Prerelease Code is not at the level of performance and compatibility of the final, generally available product offering. The Prerelease Code may not operate correctly and may be substantially modified prior to first commercial shipment. LeCroy is not obligated to make this or any later version of the Prerelease Code commercially available. The License with respect to the Prerelease Code terminates upon availability of a commercial release of the Prerelease Code from LeCroy.

2. SUPPORT SERVICES.

At LeCroy's sole discretion, from time to time, LeCroy may provide Updates to the Software Product. LeCroy shall have no obligation to revise or update the Software Product or to support any version of the Software Product. At LeCroy's sole discretion, upon your request, LeCroy may provide you with support services related to the Software Product ("Support Services") pursuant to the LeCroy policies and programs described in the Documentation or otherwise then in effect, and such Support Services will be subject to LeCroy's then-current fees therefor, if any. Any Update or other supplemental software code provided to you pursuant to the Support Services will be considered part of the Software Product and will be subject to the terms and conditions of this EULA. LeCroy may use any technical information you provide to LeCroy during LeCroy's provision of Support Services, for LeCroy's business purposes, including for product support and development. LeCroy will not utilize such technical information in a form that personally identifies you.

3. PROPRIETARY RIGHTS.

3.1 Right and Title. All right, title and interest in and to the Software Product and Documentation (including but not limited to any intellectual property or other proprietary rights, images, icons, photographs, text, and "applets" embodied in or incorporated into the Software Product, collectively, "Content"), and all Derivatives, and any copies thereof are owned by LeCroy and/or its licensors or third-party suppliers, and is protected by applicable copyright or other intellectual property laws and treaties. You will not take any action inconsistent with such title and ownership. This EULA grants you no rights to use such Content outside of the proper exercise of the license granted hereunder, and LeCroy will not be responsible or liable therefor.

3.2 Intellectual Property Protection. You may not alter or remove any printed or on-screen copyright, trade secret, proprietary or other legal notices contained on or in copies of the Software Product or Documentation.

3.3 Confidentiality. Except for the specific rights granted by this EULA, neither party shall use or disclose any Confidential Information (as defined below) of the other party without the written consent of the disclosing party. A party receiving Confidential Information from the other shall use the highest commercially reasonable degree of care to protect the Confidential Information, including ensuring that its employees and consultants with access to such Confidential Information have agreed in writing not to disclose the Confidential Information. You shall bear the responsibility for any breaches of confidentiality by your employees and consultants. Within ten (10) days after request of the disclosing party, and in the disclosing party's sole discretion, the receiving party shall either return to the disclosing party originals and copies of any Confidential Information and all information, records and materials developed therefrom by the receiving party, or destroy the same, other than such Confidential Information as to which this EULA expressly provides a continuing right to the receiving party to retain at the time of the request. Either party may only disclose the general nature, but not the specific financial terms, of this EULA without the prior consent of the other party; provided either party may provide a copy of this EULA to any finance provider in conjunction with a financing transaction, if such provider agrees to keep this EULA confidential. Nothing herein shall prevent a receiving party from disclosing all or part of the Confidential Information as necessary pursuant to the lawful requirement of a governmental agency or when disclosure is required by operation of law; provided that prior to any such disclosure, the receiving party shall use reasonable efforts to (a) promptly notify the disclosing party in writing of such requirement to disclose, and (b) cooperate fully with the disclosing party in protecting against any such disclosure or obtaining a protective order. Money damages will not be an adequate remedy if this Section 4.3 is breached and, therefore, either party shall, in addition to any other legal or equitable remedies, be entitled to seek an injunction or similar equitable relief against such breach or threatened breach without the necessity of posting any bond. As used herein, "Confidential Information" means LeCroy pricing or information concerning new LeCroy products, trade secrets (including without limitation all internal header information contained in or created by the Software Product, all benchmark and performance test results and all Documentation) and other proprietary information of LeCroy; and any business, marketing or technical information disclosed by LeCroy, or its representatives, or you in relation to this EULA, and either (i) disclosed in writing and marked as confidential at the time of disclosure or (ii) disclosed in any other manner such that a reasonable person would understand the nature and confidentiality of the information. Confidential Information does not include information (A) already in the possession of the receiving party without an obligation of confidentiality to the disclosing party, (B) hereafter rightfully furnished to the receiving party by a third party without a breach of any separate nondisclosure obligation to the disclosing party, (C) publicly known without breach of this EULA, (d) furnished by the disclosing party to a third party without restriction on subsequent disclosure, or (e) independently developed by the receiving party without reference to or reliance on the Confidential Information.

4. TERMINATION.

This EULA will remain in force until termination pursuant to the terms hereof. You may terminate this EULA at any time. This EULA will also terminate if you breach any of the terms or conditions of this EULA. You agree that if this EULA terminates for any reason, the License will immediately terminate and you will destroy all copies of the Software Product (and all Derivatives), installed or otherwise, the Documentation, and the Confidential Information (and all derivatives of any of the foregoing) that are in your possession or under your control. The provisions of Sections 1.3, 4, 6, 7, 8, and 9 will survive any termination or expiration hereof.

5. U.S. GOVERNMENT RESTRICTED RIGHTS.

If any Software Product or Documentation is acquired by or on behalf of a unit or agency of the United States Government (any such unit or agency, the "Government"), the Government agrees that the Software Product or Documentation is "commercial computer software" or "commercial computer software documentation" and that, absent a written agreement to the contrary, the Government's rights with respect to the Software Product or Documentation are, in the case of civilian agency use, Restricted Rights, as defined in FAR §52.227.19, and if for Department of Defense use, limited by the terms of this EULA, pursuant to DFARS §227.7202. The use of the Software Product or Documentation by the Government constitutes acknowledgment of LeCroy's proprietary rights in the Software Product and Documentation. Manufacturer is LeCroy Corporation, 700 Chestnut Ridge Road, Chestnut Ridge, NY 10977 USA.

6. EXPORT RESTRICTIONS.

You agree that you will not export or re-export the Software Product, any part thereof, or any process or service that is the direct product of the Software Product (the foregoing collectively referred to as the "Restricted Components"), to any country, person, entity or end user subject to U.S. export restrictions. You specifically agree not to export or re-export any of the Restricted Components (a) to any country to which the U.S. has embargoed or restricted the export of goods or services, which currently include, but are not necessarily limited to Cuba, Iran, Iraq, Libya, North Korea, Sudan and Syria, or to any national of any such country, wherever located, who intends to transmit or transport the Restricted Components back to such country; (b) to any end user who you know or have reason to know will utilize the Restricted Components in the design, development or production of nuclear, chemical or biological weapons; or (c) to any end-user who has been prohibited from participating in U.S. export transactions by any federal agency of the U.S. government. You warrant and represent that neither the BXA nor any other U.S. federal agency has suspended, revoked or denied your export privileges. It is your responsibility to comply with the latest United States export regulations, and you will defend and indemnify LeCroy from and against any damages, fines, penalties, assessments, liabilities, costs and expenses (including reasonable attorneys' fees and court costs) arising out of any claim that the Software Product, Documentation, or other information or materials provided by LeCroy hereunder were exported or otherwise accessed, shipped or transported in violation of applicable laws and regulations.

7. RISK ALLOCATION.

7.1 No Warranty. THE SOFTWARE PRODUCT IS NOT ERROR-FREE AND THE SOFTWARE PRODUCT AND SUPPORT SERVICES IS/ARE BEING PROVIDED "AS IS" WITHOUT WARRANTY OF ANY KIND. LECROY, FOR ITSELF AND ITS SUPPLIERS, HEREBY DISCLAIMS ALL WARRANTIES, WHETHER EXPRESS OR IMPLIED, ORAL OR WRITTEN, WITH RESPECT TO THE SOFTWARE PRODUCT OR ANY SUPPORT SERVICES INCLUDING, WITHOUT LIMITATION, ALL IMPLIED WARRANTIES OF TITLE OR NON-INFRINGEMENT, MERCHANTABILITY, FITNESS FOR A PARTICULAR PURPOSE, ACCURACY, INTEGRATION, VALIDITY, EXCLUSIVITY, MERCHANTABILITY, NON-INTERFERENCE WITH ENJOYMENT, FITNESS FOR ANY PARTICULAR PURPOSE, AND ALL WARRANTIES IMPLIED FROM ANY COURSE OF DEALING OR USAGE OF TRADE. YOU ACKNOWLEDGE THAT NO WARRANTIES HAVE BEEN MADE TO YOU BY OR ON BEHALF OF LECROY OR OTHERWISE FORM THE BASIS FOR THE BARGAIN BETWEEN THE PARTIES.

7.2. Limitation of Liability. LECROY'S LIABILITY FOR DAMAGES FOR ANY CAUSE

WHATSOEVER, REGARDLESS OF THE FORM OF ANY CLAIM OR ACTION, SHALL NOT EXCEED THE GREATER OF THE AMOUNT ACTUALLY PAID BY YOU FOR THE SOFTWARE PRODUCT OR U.S.\$5.00; PROVIDED THAT IF YOU HAVE ENTERED INTO A SUPPORT SERVICES AGREEMENT WITH LECROY, LECROY'S ENTIRE LIABILITY REGARDING SUPPORT SERVICES WILL BE GOVERNED BY THE TERMS OF THAT AGREEMENT. LECROY SHALL NOT BE LIABLE FOR ANY LOSS OF PROFITS, LOSS OF USE, LOSS OF DATA, INTERRUPTION OF BUSINESS, NOR FOR INDIRECT, SPECIAL, INCIDENTAL, CONSEQUENTIAL OR EXEMPLARY DAMAGES OF ANY KIND, WHETHER UNDER THIS EULA OR OTHERWISE ARISING IN ANY WAY IN CONNECTION WITH THE SOFTWARE PRODUCT, THE DOCUMENTATION OR THIS EULA. SOME JURISDICTIONS DO NOT ALLOW THE EXCLUSION OR LIMITATION OF INCIDENTAL OR CONSEQUENTIAL DAMAGES, SO THE ABOVE EXCLUSION OR LIMITATION MAY NOT APPLY TO YOU. THESE LIMITATIONS ARE INDEPENDENT FROM ALL OTHER PROVISIONS OF THIS EULA AND SHALL APPLY NOTWITHSTANDING THE FAILURE OF ANY REMEDY PROVIDED HEREIN.

7.3 Indemnification. You will defend, indemnify and hold harmless LeCroy and its officers, directors, affiliates, contractors, agents, and employees from, against and in respect of any and all assessments, damages, deficiencies, judgments, losses, obligations and liabilities (including costs of collection and reasonable attorneys' fees, expert witness fees and expenses) imposed upon or suffered or incurred by them arising from or related to your use of the Software Product.

8. GENERAL PROVISIONS.

8.1 Compliance with Laws. You will comply with all laws, legislation, rules, regulations, and governmental requirements with respect to the Software Product, and the performance by you of your obligations hereunder, of any jurisdiction in or from which you directly or indirectly cause the Software Product to be used or accessed.

8.2 No Agency. Nothing contained in this EULA will be deemed to constitute either party as the agent or representative of the other party, or both parties as joint venturers or partners for any purpose.

8.3 Entire Agreement; Waiver; Severability. This EULA constitutes the entire agreement between the parties with regard to the subject matter hereof. No provision of, right, power or privilege under this EULA will be deemed to have been waived by any act, delay, omission or acquiescence by LeCroy, its agents, or employees, but only by an instrument in writing signed by an authorized officer of LeCroy. No waiver by LeCroy of any breach or default of any provision of this EULA by you will be effective as to any other breach or default, whether of the same or any other provision and whether occurring prior to, concurrent with, or subsequent to the date of such waiver. If any provision of this EULA is declared by a court of competent jurisdiction to be invalid, illegal or unenforceable, such provision will be severed from this EULA and all the other provisions will remain in full force and effect.

8.4 Governing Law; Jurisdiction; Venue. This EULA will be governed by and construed in accordance with the laws of the State of New York, USA, without regard to its choice of law provisions. The United Nations Convention on Contracts for the International Sale of Goods will not apply to this EULA. Exclusive jurisdiction and venue for any litigation arising under this EULA is in the federal and state courts located in New York, New York, USA and both parties hereby consent to such jurisdiction and venue for this purpose.

8.5 Assignment. This EULA and the rights and obligations hereunder, may not be assigned, in whole or in part by you, except to a successor to the whole of your business, without the prior written consent of LeCroy. In the case of any permitted assignment or transfer of or under this EULA, this EULA or the relevant provisions will be binding upon, and inure to the benefit of, the successors, executors, heirs, representatives, administrators and assigns of the parties hereto.

8.6 Notices. All notices or other communications between LeCroy and you under this EULA will be in writing and delivered personally, sent by confirmed fax, by confirmed e-mail, by certified mail, postage prepaid and return receipt requested, or by a nationally recognized express delivery service. All notices will be in English and will be effective upon receipt.

8.7 Headings. The headings used in this EULA are intended for convenience only and will not be deemed to supersede or modify any provisions.

8.8 Acknowledgment. Licensee acknowledges that (a) it has read and understands this EULA, (b) it has had an opportunity to have its legal counsel review this EULA, (c) this EULA has the same force and effect as a signed agreement, and (d) issuance of this EULA does not constitute general publication of the Software Product or other Confidential Information.

Virus Protection

Because your scope runs on a Windows-based PC platform, it must be protected from viruses, as with any PC on a corporate network. It is crucial that the scope be kept up to date with Windows Critical Updates, and that anti-virus software be installed and continually updated.

Visit <http://www.lecroy.com/dsosecurity> for more information regarding Windows Service Pack compatibility with LeCroy operating software, and related matters.

Warranty

The instrument is warranted for normal use and operation, within specifications, for a period of one year from shipment. LeCroy will either repair or, at our option, replace any product returned to one of our authorized service centers within this period. However, in order to do this we must first examine the product and find that it is defective due to workmanship or materials and not due to misuse, neglect, accident, or abnormal conditions or operation.

LeCroy shall not be responsible for any defect, damage, or failure caused by any of the following: a) attempted repairs or installations by personnel other than LeCroy representatives, or b) improper connection to incompatible equipment or c) for any damage or malfunction caused by the use of non-LeCroy supplies. Furthermore, LeCroy shall not be obligated to service a product that has been modified or integrated where the modification or integration increases the task duration or difficulty of servicing the oscilloscope. Spare and replacement parts, and repairs, all have a 90-day warranty.

The oscilloscope's firmware has been thoroughly tested and is presumed to be functional. Nevertheless, it is supplied without warranty of any kind covering detailed performance. Products not made by LeCroy are covered solely by the warranty of the original equipment manufacturer.

Specifications

Note: Specifications are subject to change without notice.

Vertical System

Bandwidth (-3 dB @ 50 ohms):*

WaveMaster 8600A & 8620A [†]	6 GHz @ 50 ohms (at sample speed 20 GS/s)	
WaveMaster 8500A [‡] DDA-5005A	5 GHz	
WaveMaster 8400A, 8420	4 GHz	
DDA-3000A	3 GHz	
WavePro 7100A	5 mV/div to 1 V/div	1 GHz
	2 mV/div to 4.99 mV/div	500 MHz
WavePro 7200A	10 mV/div to 1 V/div	2 GHz
	5 mV/div to 9.95 mV/div	1 GHz
	2 mV/div to 4.99 mV/div	500 MHz
WavePro 7300A	10 mV/div to 1 V/div	3 GHz
	5 mV to 9.95 V/div	1 GHz
	2 mV/div to 4.99 mV/div	500 MHz

* At max. channel sampling rate

[†] Derates 50 MHz/°C @ T>30 °C

[‡] Derates 20 MHz/°C @ T>30 °C

Input Channels: 4

Rise Time (typical):

WaveMaster 8600A & 8620A	75 ps (at sample speed \geq 20 GS/s)
WaveMaster 8500A DDA-5005A	90 ps
WaveMaster 8400A, 8420	115 ps
DDA-3000A	150 ps
WavePro 7100A	400 ps
WavePro 7200A	225 ps
WavePro 7300A	150 ps

Bandwidth Limiters:

- Full
- 4 GHz (WaveMaster 8600A, 8500A, DDA-5005A)
- 3 GHz (WaveMaster 8600A, 8500A, 8400A, 8420, DDA-5005A)
- 1 GHz (WaveMaster scopes, DDA-5005A)
- 200 MHz
- 20 MHz

Input Impedance: 50 ohms $\pm 2\%$; WavePro 7000A Series: 50 ohms $\pm 1.5\%$, 1 Mohms

Input Coupling: DC, GND; AC (WavePro 7000A Series)



Max Input Voltage

WaveMaster, DDA-5005A: ± 4 V peak; WavePro 7000A Series, DDA-3000A: 50 ohms: 5 Vrms, 1 Mohms: 100 Vmax (peak AC: 5 kHz + DC)

Installation (Overvoltage) Category: CAT I

Vertical Resolution: 8 bits; up to 11 bits with enhanced resolution (ERES)

Sensitivity: 2 mV to 1 V/div fully variable (WavePro 7000A Series: 1 Mohms: 2 mV to 2 V/div fully variable)

DC Gain Accuracy: $\pm 1.5\%$ of full scale

Offset Range: 2 mV to 194 mV/div: ± 750 mV; 195 mV to 1 V/div: ± 4 V (WaveMaster, DDA-5005A)

DDA-3000A, WavePro 7000A Series:

50 ohms	± 700 mV @ 2.0 to 4.99 mV/div ± 1.5 V @ 5 to 100 mV/div ± 10 V @ 0.102 to 1 V/div
1 Mohms	± 700 mV @ 2.0 to 4.99 mV/div ± 1.5 V @ 5 to 100 mV/div ± 20 V @ 0.102 to 2 V/div

Offset Accuracy: $\pm(1.5\%$ of full scale value + 1.5% of offset value + 2 mV); WavePro 7000A Series, DDA-3000A: $\pm(1.5\%$ of full scale value + 0.5% of offset value + 2 mV)

Horizontal System

Timebases: Internal timebase common to 4 input channels; an external clock can be applied at the auxiliary input

Time/div Range: 20 ps/div to 1000 s/div (10 s/div in Auto trigger mode)

Math & Zoom Traces: 4 independent zoom and 4 math/zoom traces standard; 8 math/zoom traces available with XMAP (Master Analysis Package) option

Clock Accuracy: ± 1 ppm, aging < 1 ppm/year to 50 °C (WavePro 7000A Series, DDA-3000A: ≤ 10 ppm at 0 to 40 °C)

Interpolator Resolution: 1.2 ps

External Timebase Clock: 100 MHz, 50 ohms impedance, applied at the rear input (10 MHz, 50 ohms for WavePro 7000A Series)

External Sample Clock: 30 MHz to 2 GHz max., 50 ohms impedance, applied at the Auxiliary input (WavePro 7100A, DDA-3000A: 30 MHz to 1 GHz)

Acquisition System

Single-shot Sample Rate/Ch: 10 GS/s (WaveMaster 8620A: 20 GS/s)

Memory:

WaveMaster 8420A and 8620A:

	Maximum Acquisition Points/Ch
Standard	10M
VL Memory Option	32M
XL Memory Option	50M

WaveMaster 8400A XXL and 8600A XXL: 50 Mpts/Ch; 100 Mpts when using 4 or 2 Ch, respectively

WavePro 7100A, 7200A, 7300A:

	Maximum Acquisition Points/Ch 4 Ch/2 Ch
Standard	10M/20M
VL Memory Option	16M/32M
XL Memory Option	24M/50M

WavePro 7100A, 7200A, 7300A XXL models: 50 Mpts/Ch; 100 Mpts when using 4 or 2 Ch, respectively

Disk Drive Analyzers:

	Maximum Acquisition Points/Ch 4 Ch/2 Ch
DDA 3000	50 Mpts/100 Mpts
DDA 5005A	24 Mpts/50 Mpts
DDA 5005A XXL	50 Mpts/100 Mpts

Acquisition Modes

Single-shot: For transient and repetitive signals: 20 ps/div to 10 s/div

Sequence: 2 to 20,000 segments (number of segments depends upon memory option)

	Number of Segments
Standard	500
VL Memory Option	10,000
XL Memory Option	20,000
XXL Memory Option	25,000

Intersegment Time: typically 5 μ s (WavePro 7000A Series, DDA-3000A: 6 μ s)

Acquisition Processing

Averaging: Summed averaging to 1 million sweeps; Continuous averaging to 1 million sweeps

Enhanced Resolution (ERES): from 8.5 to 11 bits vertical resolution

Envelope (Extrema): Envelope, floor, roof for up to 1 million sweeps

Triggering System

Modes: Normal, Auto, Single, and Stop

Sources: Any input channel, External, ExtX10, Ext/10 or line; slope and level are unique to each source (except line)

Coupling Mode: DC; WavePro 7000A Series: GND, DC 50 ohms, DC 1 Mohms, AC 1 Mohms

Pre-trigger Delay: 0 to 100% of horizontal time scale

Post-trigger Delay: 0 to 10,000 divisions

Holdoff by Time or Events: Up to 20 s or from 1 to 99,999,999 events

Internal Trigger Range: \pm 5 div from center

Maximum Trigger Frequency:

WM 8600A	5 GHz with Edge Trigger, 750 MHz with SMART Trigger
WM 8500/8500A DDA-5005/DDA-5005A	5 GHz with Edge Trigger, 750 MHz with SMART Trigger
WM 8400A/8420	4 GHz with Edge Trigger, 750 MHz with SMART Trigger
DDA-3000A	3 GHz with Edge Trigger, 750 MHz with SMART Trigger
WP 7300A	3 GHz w/Edge Trigger, 750 MHz with SMART Trigger
WP 7200A	2 GHz w/Edge Trigger, 750 MHz with SMART Trigger
WP 7100A	1 GHz w/Edge Trigger, 750 MHz with SMART Trigger

Trigger Jitter: 2.5 ps rms (typical)

Basic Triggers

Edge/Slope/Line: Triggers when the signal meets the slope and level condition.

SMART Triggers

State or Edge qualified: Triggers on any input source only if a defined state or edge occurred on another input source. Delay between sources is selectable by time or events.

Dropout: Triggers if the input signal drops out for longer than a selectable time-out between 2 ns and 20 s.

Pattern: Logic combination (AND, NAND, OR, NOR) of 5 inputs (4 channels and external trigger input). Each source can be high, low, or don't care. The High and Low level can be selected independently. Triggers at start or end of pattern.

SMART Triggers with Exclusion Technology

Glitch: Triggers on positive or negative glitches with widths selectable from 600 ps to 20 s or on intermittent faults.

Signal or Pattern Width: Triggers on positive or negative pulse widths selectable from 600 ps to 20 s or on intermittent faults.

Signal or Pattern Interval: Triggers on intervals selectable from 2 ns to 20 s.

Automatic Setup

Autosetup: Automatically sets timebase, trigger, and sensitivity to display a wide range of repetitive signals.

Vertical Find Scale: Automatically sets the vertical sensitivity and offset for the selected channels to display a waveform with maximum dynamic range.

Probes

Probes: A variety of optional passive and active probes is available.

Probe System ProLink with ProBus: Automatically detects and supports a wide variety of

compatible probes; supports ProLink-SMA and ProLink-BNC adapters (ProLink is not available for WavePro 7000A series)

Scale Factors: Automatically or manually selected depending on probe used

AP-1M Hi-Z Adapter: (not available for WavePro 7000A series) Bandwidth: 500 MHz; full-scale range: ± 8 V; input protection: ± 150 V

Color Waveform Display

Type: Color 10.4-inch flat panel TFT LCD with high resolution touch screen

Resolution: SVGA; 800 x 600 pixels

Real Time Clock: Date, hours, minutes, and seconds displayed with waveform; SNTP support to synchronize to precision internet clocks

Number of Traces: Maximum of eight traces; simultaneously displays channel, zoom, memory, and math traces

Grid Styles: Single, Dual, Quad, Octal, XY, Single+XY, Dual+XY

Waveform Display Styles: Sample dots joined or dots only

Analog Persistence Display

Analog and Color-graded Persistence: Variable saturation levels; stores each trace's persistence data in memory

Persistence Selections: Select analog, color, or 3-D

Trace Selection: Activate Analog Persistence on all or any combination of traces

Persistence Aging Time: From 500 ms to infinity

Sweeps Displayed: All accumulated or all accumulated with last trace highlighted

Zoom Expansion Traces

Display up to 4 Zoom and 4 Math/Zoom traces; 8 Math/Zoom traces available with XMAP (Master Analysis Package) and XMATH (Advanced Math Package) options.

Rapid Signal Processing

Processor: Intel® Pentium 4 @ 2.53 GHz (or better) with MS Windows® XP Platform

Processor Memory: Up to 1 Gbyte (WaveMaster: up to 2 Gbytes with XXL memory option)

Internal Waveform Memory

Waveform: M1, M2, M3, M4 (Store full-length waveforms with 16 bits/data point.) Or save to any number of files (limited only by data storage media).

Setup Storage

Front Panel and Instrument Status: Save to the internal hard drive, floppy drive, or to a USB connected peripheral device.

Interface

Remote Control: Through Windows Automation or LeCroy Remote Command set, supports front panel controls and internal functions via GPIB or Ethernet.

GPIB Port (optional): Supports IEEE-488.2

Ethernet Port: 10/100Base-T Ethernet interface

USB Ports: 4 USB ports support Windows compatible devices.

External Monitor Port (standard): 15-pin D-Type SVGA compatible

Parallel Port: 1 standard

Auxiliary Output

Signal Types: Select from calibrator or control signals output on front panel.

Calibrator Signal: 5 Hz to 5 MHz (1 MHz for WavePro 7000A Series, DDA-3000A) square wave or DC level; 0.0 to 5.0 V (selectable) into 50 ohms (0 to 1 V into 1 Mohms), or TTL Volts

Control Signals: trigger enabled, trigger out, pass/fail status, square, DC level

Auxiliary Input

Signal Types: Select External Trigger input on front panel. 1X: 100 mV/div; 10X: 1 V/div; $\div 10$: 10 mV/div

Math Tools (standard)

Display up to four math function traces (F1 to F4). The easy-to-use graphical interface simplifies setup of up to two operations on each function trace. Function traces can be chained together to perform math-on-math.

absolute value	invert (negate)
average (summed)	ln (log base e)
average (continuous)	log (base 10)
derivative	product (X)
deskew (resample)	ratio (/)
difference ()	reciprocal
enhanced resolution (to 11 bits vertical)	rescale (with units)
envelope	roof
exp (base e)	segment
exp (base 10)	(sinX)/X
fft (basic)	square
floor	square root
histogram of 1,000 events	sum (+)
integral	trend (datalog) of 1,000 events
	zoom (identity)

Measure Tools (standard)

Display any 8 parameters together with statistics, including their average, high, low, and standard deviations. Histicons provide a fast, dynamic view of parameters and wave shape characteristics.

amplitude	number of points
area	overshoot+
base	overshoot-
cycles	peak-to-peak
delay	period
delta delay	phase
delta time @ level	rise time (10-90%, 20-80%, @ level)
duration	rms
duty cycle	std. deviation
fall time (90-10%, 80-20%, @ level)	time @ level
first	top
frequency	width
last	x @ minimum (min.)
level @ x	x @ maximum (max.)
maximum	x at max
mean	x at min
minimum	

Standard Jitter and Timing Measurements

- Period @ level
- Width @ level
- Duty Cycle @ level
- Frequency @ level
- TIE @ level
- Edge @ level
- Jitter Track
- Jitter Trend (up to 1000 points)
- Histograms (up to 1000 points)

Pass/Fail Testing

Test multiple parameters against selectable parameter limits at the same time. Pass or fail conditions can initiate actions including: document to local or networked files, email the image of the failure, save waveforms, send a pulse out at the front panel auxiliary BNC output, or (with GPIB option) send a GPIB SRQ.

Master Analysis Package (XMAP)

This package provides a comprehensive set of signal WaveShape Analysis tools that provide insight into the wave shape of complex signals. Additional analysis capability provided by XMAP includes:

- Jitter and Timing Analysis package (JTA2)
- 8 math traces total (4 additional)
- Parameter Math: add, subtract, multiply, or divide two different parameter measurements
- User-definable parameter measurements and math functions, using VBScripting with MS Excel and MATLAB
- Histograms expanded with 19 histogram parameters and up to 2 billion events
- Trend (datalog) of up to one million events
- Track graphs of any measurement parameter
- FFT capability expands the basic FFT to include; power averaging, power density, real and imaginary components, frequency domain parameters and FFT on up to 25 Mpts.
- Narrow Band power measurements
- Correlation function
- Interpolation
- Sparse

Jitter and Timing Analysis Package (JTA2)

This package provides jitter timing and analysis using JitterTrack (time), Histogram (statistical) and JitterFFT (frequency) views for common timing parameters, and other useful tools.

- Jitter and Timing parameters with JitterTrack graphs of:

Cycle-to-Cycle	Half Period	Skew
N-Cycle	Width	Duty Cycle
N-Cycle with Start selection	Time Interval Error	Duty Cycle Error (Delta Width)
Frequency	Setup	
Period	Hold	

- edge@lv parameter (counts edges)
- Histograms expanded with 19 histogram parameters and up to 2 billion events
- Trend (datalog) of up to one million events
- Persistence Histogram; Persistence Trace

Disk Drive Measurement Package (DDM2)

This package provides disk drive parameter measurements and related mathematical functions for performing disk drive WaveShape Analysis.

- Disk Drive Parameters:

amplitude symmetry	local time over threshold
auto correlation s/n	local time trough-peak
local base	local time under threshold
local baseline separation	narrow band phase
local maximum	narrow band power
local minimum	non-linear transition shift
local number	overwrite
local peak-peak	pulse width 50
local time between events	pulse width 50-
local time between peaks	pulse width 50+
local time between troughs	resolution
local time at minimum	track average amplitude
local time at maximum	track average amplitude-
local time peak-trough	track average amplitude+

- Correlation function
- Trend (datalog) of up to one million events
- Histograms expanded with 19 histogram parameters and up to 2 billion events

General

Auto Calibration: Ensures specified DC and timing accuracy is maintained for 1 year minimum.

Power Requirements:

On State:

WaveMaster 8620A, 8420	<=/= 800 watts (800 VA) depending on accessories installed (internal printer, probes, PC port plug-ins, etc.)
WaveMaster 8600A, 8500A, 8400A, WavePro 7000A Series DDA-5005A, 3000A	<=/= 650 watts (650 VA) depending on accessories installed (internal printer, probes, PC port plug-ins, etc.)

Standby State: 12 watts

Fuse: One 5x20 mm fuse (T10.0 A/250 V)

Battery Backup: Front panel settings retained for two years minimum

Physical Dimensions (HWD): 264 mm x 397 mm x 491 mm (10.4 in. x 15.6 in. x 19.3 in.); height measurement excludes foot pads

Weight: 18 kg (39 lbs.)

Shipping Weight: 24 kg (53 lbs.)

Warranty and Service

3-year warranty; calibration recommended yearly

Optional service programs include extended warranty, upgrades, and calibration services.

Environmental Characteristics

Temperature

Operating: 5 to 40 °C

Storage (non-operating): -20 to +60 °C

Humidity

Operating: Maximum relative humidity 80% for temperatures up to 31 °C decreasing linearly to 50% relative humidity at 40 °C

Storage (non-operating): 5 to 95% RH (non-condensing) as tested per MIL-PRF-28800F

Altitude

Operating: Up to 2,000 m

Storage (non-operating): Up to 12,192 m (40,000 ft)

Random Vibration

Operating: 0.31 g_{rms}, 5 Hz to 500 Hz, 15 minutes in each of 3 orthogonal axes

Non-operating: 2.4 g_{rms}, 5 to 500 Hz, 15 minutes in each of 3 orthogonal axes

Shock

Functional Shock: 20 g peak, half sine, 11 ms pulse, 3 shocks (positive and negative) in each of 3 orthogonal axes, 18 shocks total

Certifications

CE Approved, UL and cUL Listed

CE Declaration of Conformity

The oscilloscope meets requirements of EMC Directive 89/336/EEC for Electromagnetic Compatibility and Low Voltage Directive 73/23/EEC for Product Safety.

EMC Directive:	EN 61326/A3:2003 EMC requirements for electrical equipment for measurement, control, and laboratory use.
Electromagnetic Emissions:	EN 55011/A2:2002, Class A Radiated and conducted emissions (Class A)*
	EN 61000-3-2/A2:2005 Harmonic Current Emissions (Class A)
	EN 61000-3-3/A2:2005 Voltage Fluctuations and Flickers (Pst = 1)

* To conform to Radiated Emissions standard, use properly shielded cables on all I/O terminals.



Warning

This is a Class A product. In a domestic environment this product may cause radio interference, in which case the user may be required to take appropriate measures.

Electromagnetic Immunity:	EN 61000-4-2/A2:2001* Electrostatic Discharge (4 kV contact, 8 kV air, 4 kV vertical/horizontal coupling planes)
	EN 61000-4-3/A1:2003* RF Radiated Electromagnetic Field (3 V/m, 80-1000 MHz)
	EN 61000-4-5/A1:2001* Electrical Fast Transient/Burst (1 kV AC Mains, 0.5 kV I/O signal/control)
	EN 61000-4-5:1995* Surges (1 kV AC Mains, 0.5 kV I/O signal/control)
	EN 61000-4-6/A1:2001* RF Conducted Electromagnetic Field (1 kV / 0.5 kV common mode / differential mode - AC Mains)
	EN 61000-4-11:2004† Mains Dips and Interruptions (1 cycle voltage dip, 100% short interruption)

* Meets Performance Criteria "B" limits during the disturbance, product undergoes a temporary degradation or loss of function of performance which is self recoverable.

† Meets Performance Criteria "C" limits during the disturbance, product undergoes a temporary degradation or loss of function of performance which requires operator intervention or system reset.

Low Voltage Directive:	EN 61010-1:2001
	Safety requirements for electrical equipment for measurement, control, and laboratory use.
	The oscilloscope has been qualified to the following EN 61010-1 limits: Installation Categories II (Mains Supply Connector) & I (Measuring Terminals) Pollution Degree 2 (Normally only dry non-conductive pollution occurs. Occasionally a temporary conductivity caused by condensation must be expected.) Protection Class I (Provided with terminal for protective ground)

UL and cUL Certifications:	UL Standard: UL 3111-1
	Canadian Standard: CSA-C22.2 No. 1010.1-92

Warranty

The instrument is warranted for normal use and operation, within specifications, for a period of three years from shipment. LeCroy will either repair or, at our option, replace any product returned to one of our authorized service centers within this period. However, in order to do this we must first examine the product and find that it is defective due to workmanship or materials and not due to misuse, neglect, accident, or abnormal conditions or operation.

LeCroy shall not be responsible for any defect, damage, or failure caused by any of the following: a) attempted repairs or installations by personnel other than LeCroy representatives or b) improper connection to incompatible equipment, or c) for any damage or malfunction caused by the use of non-LeCroy supplies. Furthermore, LeCroy shall not be obligated to service a product that has been modified or integrated where the modification or integration increases the task duration or difficulty of servicing the oscilloscope. Spare and replacement parts, and repairs, all have a 90-day warranty.

The oscilloscope's firmware has been thoroughly tested and is presumed to be functional. Nevertheless, it is supplied without warranty of any kind covering detailed performance. Products not made by LeCroy are covered solely by the warranty of the original equipment manufacturer.

Windows License Agreement

LeCroy's agreement with Microsoft prohibits users from running software on LeCroy X-Stream oscilloscopes that is not relevant to measuring, analyzing, or documenting waveforms.

End-User License Agreement For LeCroy X-Stream Software

IMPORTANT-READ CAREFULLY: THIS END-USER LICENSE AGREEMENT ("EULA") IS A LEGAL AGREEMENT BETWEEN THE INDIVIDUAL OR ENTITY LICENSING THE SOFTWARE PRODUCT ("YOU" OR "YOUR") AND LECROY CORPORATION ("LECROY") FOR THE SOFTWARE PRODUCT(S) ACCOMPANYING THIS EULA, WHICH INCLUDE(S): COMPUTER PROGRAMS; ANY "ONLINE" OR ELECTRONIC DOCUMENTATION AND PRINTED MATERIALS PROVIDED BY LECROY HERewith ("DOCUMENTATION"); ASSOCIATED MEDIA; AND ANY UPDATES (AS DEFINED BELOW) (COLLECTIVELY, THE "SOFTWARE PRODUCT"). BY USING AN INSTRUMENT TOGETHER WITH OR CONTAINING THE SOFTWARE PRODUCT, OR BY INSTALLING, COPYING, OR OTHERWISE USING THE SOFTWARE PRODUCT, IN WHOLE OR IN PART, YOU AGREE TO BE BOUND BY THE TERMS OF THIS EULA. IF YOU DO NOT AGREE TO THE TERMS OF THIS EULA, DO NOT INSTALL, COPY, OR OTHERWISE USE THE SOFTWARE PRODUCT; YOU MAY RETURN THE SOFTWARE PRODUCT TO YOUR PLACE OF PURCHASE FOR A FULL REFUND. IN ADDITION, BY INSTALLING, COPYING, OR OTHERWISE USING ANY MODIFICATIONS, ENHANCEMENTS, NEW VERSIONS, BUG FIXES, OR OTHER COMPONENTS OF THE SOFTWARE PRODUCT THAT LECROY PROVIDES TO YOU SEPARATELY AS PART OF THE SOFTWARE PRODUCT ("UPDATES"), YOU AGREE TO BE BOUND BY ANY ADDITIONAL LICENSE TERMS THAT ACCOMPANY SUCH UPDATES. IF YOU DO NOT AGREE TO SUCH ADDITIONAL LICENSE TERMS, YOU MAY NOT INSTALL, COPY, OR OTHERWISE USE SUCH UPDATES.

THE PARTIES CONFIRM THAT THIS AGREEMENT AND ALL RELATED DOCUMENTATION ARE AND WILL BE DRAFTED IN ENGLISH. LES PARTIES AUX PRÉSENTÉS CONFIRMENT

LEUR VOLONTÉ QUE CETTE CONVENTION DE MÊME QUE TOUS LES DOCUMENTS Y COMPRIS TOUT AVIS QUI S'Y RATTACHÉ, SOIENT REDIGÉS EN LANGUE ANGLAISE.

1. GRANT OF LICENSE

1.1 License Grant. Subject to the terms and conditions of this EULA and payment of all applicable fees, LeCroy grants to you a nonexclusive, nontransferable license (the "License") to: (a) operate the Software Product as provided or installed, in object code form, for your own internal business purposes, (i) for use in or with an instrument provided or manufactured by LeCroy (an "Instrument"), (ii) for testing your software product(s) (to be used solely by you) that are designed to operate in conjunction with an Instrument ("Your Software"), and (iii) make one copy for archival and back-up purposes; (b) make and use copies of the Documentation; provided that such copies will be used only in connection with your licensed use of the Software Product, and such copies may not be republished or distributed (either in hard copy or electronic form) to any third party; and (c) copy, modify, enhance and prepare derivative works ("Derivatives") of the source code version of those portions of the Software Product set forth in and identified in the Documentation as "Samples" ("Sample Code") for the sole purposes of designing, developing, and testing Your Software. If you are an entity, only one designated individual within your organization, as designated by you, may exercise the License; provided that additional individuals within your organization may assist with respect to reproducing and distributing Sample Code as permitted under Section 1.1(c)(ii). LeCroy reserves all rights not expressly granted to you. No license is granted hereunder for any use other than that specified herein, and no license is granted for any use in combination or in connection with other products or services (other than Instruments and Your Software) without the express prior written consent of LeCroy. The Software Product is licensed as a single product. Its component parts may not be separated for use by more than one user. This EULA does not grant you any rights in connection with any trademarks or service marks of LeCroy. The Software Product is protected by copyright laws and international copyright treaties, as well as other intellectual property laws and treaties. The Software Product is licensed, not sold. The terms of this printed, paper EULA supersede the terms of any on-screen license agreement found within the Software Product.

1.2 Upgrades. If the Software Product is labeled as an "upgrade," (or other similar designation) the License will not take effect, and you will have no right to use or access the Software Product unless you are properly licensed to use a product identified by LeCroy as being eligible for the upgrade ("Underlying Product"). A Software Product labeled as an "upgrade" replaces and/or supplements the Underlying Product. You may use the resulting upgraded product only in accordance with the terms of this EULA. If the Software Product is an upgrade of a component of a package of software programs that you licensed as a single product, the Software Product may be used and transferred only as part of that single product package and may not be separated for use on more than one computer.

1.3 Limitations. Except as specifically permitted in this EULA, you will not directly or indirectly (a) use any Confidential Information to create any software or documentation that is similar to any of the Software Product or Documentation; (b) encumber, transfer, rent, lease, time-share or use the Software Product in any service bureau arrangement; (c) copy (except for archival purposes), distribute, manufacture, adapt, create derivative works of, translate, localize, port or otherwise modify the Software Product or the Documentation; (d) permit access to the Software Product by any party developing, marketing or planning to develop or market any product having functionality similar to or competitive with the Software Product; (e) publish benchmark results relating to the

Software Product, nor disclose Software Product features, errors or bugs to third parties; or (f) permit any third party to engage in any of the acts proscribed in clauses (a) through (e). In jurisdictions in which transfer is permitted, notwithstanding the foregoing prohibition, transfers will only be effective if you transfer a copy of this EULA, as well as all copies of the Software Product, whereupon your right to use the Software product will terminate. Except as described in this Section 1.3, You are not permitted (i) to decompile, disassemble, reverse compile, reverse assemble, reverse translate or otherwise reverse engineer the Software Product, (ii) to use any similar means to discover the source code of the Software Product or to discover the trade secrets in the Software Product, or (iii) to otherwise circumvent any technological measure that controls access to the Software Product. You may reverse engineer or otherwise circumvent the technological measures protecting the Software Product for the sole purpose of identifying and analyzing those elements that are necessary to achieve Interoperability (the “Permitted Objective”) only if: (A) doing so is necessary to achieve the Permitted Objective and it does not constitute infringement under Title 17 of the United States Code; (B) such circumvention is confined to those parts of the Software Product and to such acts as are necessary to achieve the Permitted Objective; (C) the information to be gained thereby has not already been made readily available to you or has not been provided by LeCroy within a reasonable time after a written request by you to LeCroy to provide such information; (D) the information gained is not used for any purpose other than the Permitted Objective and is not disclosed to any other person except as may be necessary to achieve the Permitted Objective; and (E) the information obtained is not used (1) to create a computer program substantially similar in its expression to the Software Product including, but not limited to, expressions of the Software Product in other computer languages, or (2) for any other act restricted by LeCroy’s intellectual property rights in the Software Product. “Interoperability” will have the same meaning in this EULA as defined in the Digital Millennium Copyright Act, 17 U.S.C. §1201(f), the ability of computer programs to exchange information and of such programs mutually to use the information which has been exchanged.

1.4 Prerelease Code. Portions of the Software Product may be identified as prerelease code (“Prerelease Code”). Prerelease Code is not at the level of performance and compatibility of the final, generally available product offering. The Prerelease Code may not operate correctly and may be substantially modified prior to first commercial shipment. LeCroy is not obligated to make this or any later version of the Prerelease Code commercially available. The License with respect to the Prerelease Code terminates upon availability of a commercial release of the Prerelease Code from LeCroy.

2. SUPPORT SERVICES

At LeCroy’s sole discretion, from time to time, LeCroy may provide Updates to the Software Product. LeCroy shall have no obligation to revise or update the Software Product or to support any version of the Software Product. At LeCroy’s sole discretion, upon your request, LeCroy may provide you with support services related to the Software Product (“Support Services”) pursuant to the LeCroy policies and programs described in the Documentation or otherwise then in effect, and such Support Services will be subject to LeCroy’s then-current fees therefor, if any. Any Update or other supplemental software code provided to you pursuant to the Support Services will be considered part of the Software Product and will be subject to the terms and conditions of this EULA. LeCroy may use any technical information you provide to LeCroy during LeCroy’s provision of Support Services, for LeCroy’s business purposes, including for product support and development. LeCroy will not utilize such technical information in a form that personally identifies

you.

3. PROPRIETARY RIGHTS

3.1 Right and Title. All right, title and interest in and to the Software Product and Documentation (including but not limited to any intellectual property or other proprietary rights, images, icons, photographs, text, and “applets” embodied in or incorporated into the Software Product, collectively, “Content”), and all Derivatives, and any copies thereof are owned by LeCroy and/or its licensors or third-party suppliers, and is protected by applicable copyright or other intellectual property laws and treaties. You will not take any action inconsistent with such title and ownership. This EULA grants you no rights to use such Content outside of the proper exercise of the license granted hereunder, and LeCroy will not be responsible or liable therefor.

3.2 Intellectual Property Protection. You may not alter or remove any printed or on-screen copyright, trade secret, proprietary or other legal notices contained on or in copies of the Software Product or Documentation.

3.3 Confidentiality. Except for the specific rights granted by this EULA, neither party shall use or disclose any Confidential Information (as defined below) of the other party without the written consent of the disclosing party. A party receiving Confidential Information from the other shall use the highest commercially reasonable degree of care to protect the Confidential Information, including ensuring that its employees and consultants with access to such Confidential Information have agreed in writing not to disclose the Confidential Information. You shall bear the responsibility for any breaches of confidentiality by your employees and consultants. Within ten (10) days after request of the disclosing party, and in the disclosing party's sole discretion, the receiving party shall either return to the disclosing party originals and copies of any Confidential Information and all information, records and materials developed therefrom by the receiving party, or destroy the same, other than such Confidential Information as to which this EULA expressly provides a continuing right to the receiving party to retain at the time of the request. Either party may only disclose the general nature, but not the specific financial terms, of this EULA without the prior consent of the other party; provided either party may provide a copy of this EULA to any finance provider in conjunction with a financing transaction, if such provider agrees to keep this EULA confidential. Nothing herein shall prevent a receiving party from disclosing all or part of the Confidential Information as necessary pursuant to the lawful requirement of a governmental agency or when disclosure is required by operation of law; provided that prior to any such disclosure, the receiving party shall use reasonable efforts to (a) promptly notify the disclosing party in writing of such requirement to disclose, and (b) cooperate fully with the disclosing party in protecting against any such disclosure or obtaining a protective order. Money damages will not be an adequate remedy if this Section 4.3 is breached and, therefore, either party shall, in addition to any other legal or equitable remedies, be entitled to seek an injunction or similar equitable relief against such breach or threatened breach without the necessity of posting any bond. As used herein, “Confidential Information” means LeCroy pricing or information concerning new LeCroy products, trade secrets (including without limitation all internal header information contained in or created by the Software Product, all benchmark and performance test results and all Documentation) and other proprietary information of LeCroy; and any business, marketing or technical information disclosed by LeCroy, or its representatives, or you in relation to this EULA, and either (i) disclosed in writing and marked as confidential at the time of disclosure or (ii) disclosed in any other manner such that a reasonable person would understand the nature and confidentiality of the information. Confidential Information does not include information (A) already in the possession of the receiving party without an

obligation of confidentiality to the disclosing party, (B) hereafter rightfully furnished to the receiving party by a third party without a breach of any separate nondisclosure obligation to the disclosing party, (C) publicly known without breach of this EULA, (d) furnished by the disclosing party to a third party without restriction on subsequent disclosure, or (e) independently developed by the receiving party without reference to or reliance on the Confidential Information.

4. TERMINATION

This EULA will remain in force until termination pursuant to the terms hereof. You may terminate this EULA at any time. This EULA will also terminate if you breach any of the terms or conditions of this EULA. You agree that if this EULA terminates for any reason, the License will immediately terminate and you will destroy all copies of the Software Product (and all Derivatives), installed or otherwise, the Documentation, and the Confidential Information (and all derivatives of any of the foregoing) that are in your possession or under your control. The provisions of Sections 1.3, 4, 6, 7, 8, and 9 will survive any termination or expiration hereof.

5. U.S. GOVERNMENT RESTRICTED RIGHTS

If any Software Product or Documentation is acquired by or on behalf of a unit or agency of the United States Government (any such unit or agency, the "Government"), the Government agrees that the Software Product or Documentation is "commercial computer software" or "commercial computer software documentation" and that, absent a written agreement to the contrary, the Government's rights with respect to the Software Product or Documentation are, in the case of civilian agency use, Restricted Rights, as defined in FAR §52.227.19, and if for Department of Defense use, limited by the terms of this EULA, pursuant to DFARS §227.7202. The use of the Software Product or Documentation by the Government constitutes acknowledgment of LeCroy's proprietary rights in the Software Product and Documentation. Manufacturer is LeCroy Corporation, 700 Chestnut Ridge Road, Chestnut Ridge, NY 10977 USA.

6. EXPORT RESTRICTIONS

You agree that you will not export or re-export the Software Product, any part thereof, or any process or service that is the direct product of the Software Product (the foregoing collectively referred to as the "Restricted Components"), to any country, person, entity or end user subject to U.S. export restrictions. You specifically agree not to export or re-export any of the Restricted Components (a) to any country to which the U.S. has embargoed or restricted the export of goods or services, which currently include, but are not necessarily limited to Cuba, Iran, Iraq, Libya, North Korea, Sudan and Syria, or to any national of any such country, wherever located, who intends to transmit or transport the Restricted Components back to such country; (b) to any end user who you know or have reason to know will utilize the Restricted Components in the design, development or production of nuclear, chemical or biological weapons; or (c) to any end-user who has been prohibited from participating in U.S. export transactions by any federal agency of the U.S. government. You warrant and represent that neither the BXA nor any other U.S. federal agency has suspended, revoked or denied your export privileges. It is your responsibility to comply with the latest United States export regulations, and you will defend and indemnify LeCroy from and against any damages, fines, penalties, assessments, liabilities, costs and expenses (including reasonable attorneys' fees and court costs) arising out of any claim that the Software Product, Documentation, or other information or materials provided by LeCroy hereunder were exported or otherwise accessed, shipped or transported in violation of applicable laws and regulations.

7. RISK ALLOCATION

7.1 No Warranty. THE SOFTWARE PRODUCT IS NOT ERROR-FREE AND THE SOFTWARE PRODUCT AND SUPPORT SERVICES IS/ARE BEING PROVIDED "AS IS" WITHOUT WARRANTY OF ANY KIND. LECROY, FOR ITSELF AND ITS SUPPLIERS, HEREBY DISCLAIMS ALL WARRANTIES, WHETHER EXPRESS OR IMPLIED, ORAL OR WRITTEN, WITH RESPECT TO THE SOFTWARE PRODUCT OR ANY SUPPORT SERVICES INCLUDING, WITHOUT LIMITATION, ALL IMPLIED WARRANTIES OF TITLE OR NON-INFRINGEMENT, MERCHANTABILITY, FITNESS FOR A PARTICULAR PURPOSE, ACCURACY, INTEGRATION, VALIDITY, EXCLUSIVITY, MERCHANTABILITY, NON-INTERFERENCE WITH ENJOYMENT, FITNESS FOR ANY PARTICULAR PURPOSE, AND ALL WARRANTIES IMPLIED FROM ANY COURSE OF DEALING OR USAGE OF TRADE. YOU ACKNOWLEDGE THAT NO WARRANTIES HAVE BEEN MADE TO YOU BY OR ON BEHALF OF LECROY OR OTHERWISE FORM THE BASIS FOR THE BARGAIN BETWEEN THE PARTIES.

7.2. Limitation of Liability. LECROY'S LIABILITY FOR DAMAGES FOR ANY CAUSE WHATSOEVER, REGARDLESS OF THE FORM OF ANY CLAIM OR ACTION, SHALL NOT EXCEED THE GREATER OF THE AMOUNT ACTUALLY PAID BY YOU FOR THE SOFTWARE PRODUCT OR U.S.\$5.00; PROVIDED THAT IF YOU HAVE ENTERED INTO A SUPPORT SERVICES AGREEMENT WITH LECROY, LECROY'S ENTIRE LIABILITY REGARDING SUPPORT SERVICES WILL BE GOVERNED BY THE TERMS OF THAT AGREEMENT. LECROY SHALL NOT BE LIABLE FOR ANY LOSS OF PROFITS, LOSS OF USE, LOSS OF DATA, INTERRUPTION OF BUSINESS, NOR FOR INDIRECT, SPECIAL, INCIDENTAL, CONSEQUENTIAL OR EXEMPLARY DAMAGES OF ANY KIND, WHETHER UNDER THIS EULA OR OTHERWISE ARISING IN ANY WAY IN CONNECTION WITH THE SOFTWARE PRODUCT, THE DOCUMENTATION OR THIS EULA. SOME JURISDICTIONS DO NOT ALLOW THE EXCLUSION OR LIMITATION OF INCIDENTAL OR CONSEQUENTIAL DAMAGES, SO THE ABOVE EXCLUSION OR LIMITATION MAY NOT APPLY TO YOU. THESE LIMITATIONS ARE INDEPENDENT FROM ALL OTHER PROVISIONS OF THIS EULA AND SHALL APPLY NOTWITHSTANDING THE FAILURE OF ANY REMEDY PROVIDED HEREIN.

7.3 Indemnification. You will defend, indemnify and hold harmless LeCroy and its officers, directors, affiliates, contractors, agents, and employees from, against and in respect of any and all assessments, damages, deficiencies, judgments, losses, obligations and liabilities (including costs of collection and reasonable attorneys' fees, expert witness fees and expenses) imposed upon or suffered or incurred by them arising from or related to your use of the Software Product.

8. GENERAL PROVISIONS

8.1 Compliance with Laws. You will comply with all laws, legislation, rules, regulations, and governmental requirements with respect to the Software Product, and the performance by you of your obligations hereunder, of any jurisdiction in or from which you directly or indirectly cause the Software Product to be used or accessed.

8.2 No Agency. Nothing contained in this EULA will be deemed to constitute either party as the agent or representative of the other party, or both parties as joint venturers or partners for any purpose.

8.3 Entire Agreement; Waiver; Severability. This EULA constitutes the entire agreement between the parties with regard to the subject matter hereof. No provision of, right, power or privilege under

this EULA will be deemed to have been waived by any act, delay, omission or acquiescence by LeCroy, its agents, or employees, but only by an instrument in writing signed by an authorized officer of LeCroy. No waiver by LeCroy of any breach or default of any provision of this EULA by you will be effective as to any other breach or default, whether of the same or any other provision and whether occurring prior to, concurrent with, or subsequent to the date of such waiver. If any provision of this EULA is declared by a court of competent jurisdiction to be invalid, illegal or unenforceable, such provision will be severed from this EULA and all the other provisions will remain in full force and effect.

8.4 Governing Law; Jurisdiction; Venue. This EULA will be governed by and construed in accordance with the laws of the State of New York, USA, without regard to its choice of law provisions. The United Nations Convention on Contracts for the International Sale of Goods will not apply to this EULA. Exclusive jurisdiction and venue for any litigation arising under this EULA is in the federal and state courts located in New York, New York, USA and both parties hereby consent to such jurisdiction and venue for this purpose.

8.5 Assignment. This EULA and the rights and obligations hereunder, may not be assigned, in whole or in part by you, except to a successor to the whole of your business, without the prior written consent of LeCroy. In the case of any permitted assignment or transfer of or under this EULA, this EULA or the relevant provisions will be binding upon, and inure to the benefit of, the successors, executors, heirs, representatives, administrators and assigns of the parties hereto.

8.6 Notices. All notices or other communications between LeCroy and you under this EULA will be in writing and delivered personally, sent by confirmed fax, by confirmed e-mail, by certified mail, postage prepaid and return receipt requested, or by a nationally recognized express delivery service. All notices will be in English and will be effective upon receipt.

8.7 Headings. The headings used in this EULA are intended for convenience only and will not be deemed to supersede or modify any provisions.

8.8 Acknowledgment. Licensee acknowledges that (a) it has read and understands this EULA, (b) it has had an opportunity to have its legal counsel review this EULA, (c) this EULA has the same force and effect as a signed agreement, and (d) issuance of this EULA does not constitute general publication of the Software Product or other Confidential Information.

Virus Protection

Because your digital storage oscilloscope (DSO) runs on a Windows-based PC platform, it must be protected from viruses, as with any PC on a corporate network. It is crucial that the scope be kept up to date with Windows Critical Updates, and that anti-virus software be installed and continually updated.

Visit <http://www.lecroy.com/dsosecurity> for more information regarding Windows Service Pack compatibility with LeCroy operating software, and related matters.

SAFETY

Safety Requirements

This section contains information and warnings that must be observed to keep the instrument operating in a correct and safe condition. You are required to follow generally accepted safety procedures in addition to the safety precautions specified in this section.

Safety Symbols

Where the following symbols appear on the instrument's front or rear panels, or in this manual, they alert you to important safety considerations.



This symbol is used where caution is required. Refer to the accompanying information or documents in order to protect against personal injury or damage to the instrument.



This symbol warns of a potential risk of shock hazard.



This symbol is used to denote the measurement ground connection.



This symbol is used to denote a safety ground connection.



This symbol is used to denote a grounded frame or chassis terminal.



This symbol shows that the switch is a Standby (power) switch. When it is pressed, the scope's state toggles between operating and Standby mode. This switch is not a disconnect device. The instrument can only be placed in a complete Power Off state by unplugging the power cord from the AC supply.



This symbol is used to denote "Alternating Current."

CAUTION The CAUTION sign indicates a potential hazard. It calls attention to a procedure, practice or condition which, if not followed, could possibly cause damage to equipment. If a CAUTION is indicated, do not proceed until its conditions are fully understood and met.

WARNING The WARNING sign indicates a potential hazard. It calls attention to a procedure, practice or condition which, if not followed, could possibly cause bodily injury or death. If a WARNING is indicated, do not proceed until its conditions are fully understood and met.

CAT I Installation (Overvoltage) Category rating per EN 61010-1 safety standard and is applicable for the oscilloscope front panel measuring terminals. CAT I rated terminals must only be connected to source circuits in which measures are taken to limit transient voltages to an appropriately low level.

Operating Environment

The instrument is intended for indoor use and should be operated in a clean, dry environment. Before using this product, ensure that its operating environment will be maintained within these parameters:

Temperature: 5 to 40 °C

Humidity: Maximum relative humidity 80% for temperatures up to 31 °C decreasing linearly to 50% relative humidity at 40 °C.

Altitude: Up to 2,000 m

Note: Direct sunlight, radiators, and other heat sources should be taken into account when assessing the ambient temperature.



WARNING

The scope must not be operated in explosive, dusty, or wet atmospheres.



CAUTION

Protect the scope's display touch screen from excessive impacts with foreign objects.



CAUTION

Do not exceed the maximum specified front panel terminal (CH1, CH1, CH2, CH3, CH4, AUX IN) voltage levels. Refer to Specifications for more details.

Installation (Overvoltage) Category II refers to local distribution level, which is applicable to equipment connected to the mains supply (AC power source).
 Installation (Overvoltage) Category I refers to signal level, which is applicable to equipment measuring terminals that are connected to source circuits in which measures are taken to limit transient voltages to an appropriately low level.
 Pollution Degree 2 refers to an operating environment where normally only dry non-conductive pollution occurs. Occasionally a temporary conductivity caused by condensation must be expected.
 Protection Class 1 refers to a grounded equipment, in which protection against electric shock is achieved by Basic Insulation and by means of a connection to the protective ground conductor in the building wiring.

Note
 The design of the instrument has been verified to conform to EN 61010-1 safety standard per the following limits:
 Installation (Overvoltage) Categories II (Mains Supply Connector) & I (Measuring Terminals)
 Pollution Degree 2
 Protection Class I

Cooling

The instrument relies on forced air cooling with internal fans and ventilation openings. Care must be taken to avoid restricting the airflow around the apertures (fan holes) at the sides and rear of the scope. To ensure adequate ventilation it is required to leave a 10 cm (4 inch) minimum gap around the sides and rear of the instrument.



Do not block the ventilation holes located on both sides and rear of the scope.

The instrument also has internal fan control circuitry that regulates the fan speed based on the ambient temperature. This is performed automatically after start-up with no manual intervention required.



Do not allow any foreign matter to enter the scope through the ventilation holes, etc.

AC Power Source

100 to 240 Vrms ($\pm 10\%$) AC at 50/60 Hz; 115 Vrms ($\pm 10\%$) AC at 400 Hz; Automatic AC voltage selection; Installation Category: 300V CAT II

Note:
 The instrument automatically adapts itself to the AC line input within the following ranges:

No manual voltage selection is required because the instrument automatically adapts to line voltage.

WaveMaster 8620A, 8420	<= 800 watts (800 VA) depending on accessories installed (internal printer, probes, PC port plug-ins, etc.)
------------------------	---

Voltage Range	90 to 132 VAC	180 to 264 VAC
Frequency Range	45 to 440 Hz	45 to 66 Hz

WaveMaster 8600A, 8500A, 8400A, WavePro 7000A Series DDA-5005A, 3000A	<= 650 watts (650 VA) depending on accessories installed (internal printer, probes, PC port plug-ins, etc.)
---	---

The power supply of the scope is protected against short circuit and overload by a 5x20 mm fuse (T10.0 A/250 V). See "Fuse Replacement" section for replacement instructions.

Power and Ground Connections

The instrument is provided with a grounded cord set containing a molded three-terminal polarized plug and a standard IEC320 (Type C13) connector for making line voltage and safety ground connection. The AC inlet ground terminal is connected directly to the frame of the instrument. For adequate protection against electrical shock hazard, the power cord plug must be inserted into a mating AC outlet containing a safety ground contact.



WARNING
Electrical Shock Hazard!
Any interruption of the protective conductor inside or outside of the scope, or disconnection of the safety ground terminal creates a hazardous situation.

Intentional interruption is prohibited.

In Standby mode the scope is still connected to the AC supply. The instrument can only be placed in a complete Power Off state by physically disconnecting the power cord from the AC supply.



CAUTION
The outer shells of the front panel terminals (CH1, CH2, CH3, CH4, AUX IN, AUX OUT) are connected to the instrument's chassis and therefore to the safety ground.

The scope should be positioned to allow easy access to the socket-outlet. To disconnect the scope from the AC supply, unplug the instrument's power cord from the AC outlet after the scope is placed in Standby state.

See "Standby (Power) Switch and Scope Operational States" section for more information.

Standby (Power) Switch and Scope Operational States

The front Standby (Power) switch controls the operational state of the scope. This toggle switch is activated by momentarily pressing and releasing it. The color of the LED below the switch indicates the status of the scope as follows:

On (LED Green)* scope is fully powered and operational

Standby (LED Off)* scope is powered off (except for some "housekeeping" circuits)

Standby (LED Red) scope's computer subsystems (hard drive, etc.) are in Standby (reduced Power mode). All other scope subsystems are fully powered.

* Factory Settings

The scope's factory settings result in only two basic scope states: On (LED Green) or Standby (LED Off). In this case of Standby (LED Off), the scope is powered off with the exception of some "housekeeping" circuitry (approximately 12 watts dissipation). The scope can only be placed in a complete power off state by unplugging the instrument's power cord from the primary power source (AC outlet). It is recommended that the power cord be unplugged from the AC outlet if the scope is not being used for an extended period of time.

You have the ability to change the scope original factory settings via the "Power Options Properties" menu in Windows by following the path: Settings Power Options. It is important to note that the Windows Power Option named "Standby" provides control of only the scope's computer subsystems (CPU, hard drive, etc.) and does not affect the other subsystems within the scope. In general, these other subsystems remain fully powered. For additional information on setting these Power Options, see the Windows Help menu or other related technical documentation. In terms of control buttons, this scope uses only a power button/switch and therefore references to a sleep button are not applicable.

The scope can always be placed in the Standby state (LED Off) Power Off (except for some "housekeeping" circuits) by pressing and holding in the Standby toggle switch for approximately 5 seconds.

Fuse Replacement

Set the scope's Standby (power) switch to Standby mode (LED off) and disconnect the power cord before inspecting or replacing the fuse. Open the black fuse holder (located at the rear of the instrument directly to the right of the AC inlet) using a small, flat-bladed screwdriver. Remove the old fuse, replace it with a new 5x20 mm "T" rated 10.0 A/250 V fuse, and reinstall the fuse holder.



WARNING

For continued fire protection at all line voltages, replace fuse with the specified type and rating only. Disconnect the power cord before replacing fuse.

Calibration

The recommended calibration interval is one year. Calibration should be performed by qualified personnel only.

Cleaning

Clean only the exterior of the instrument, using a damp, soft cloth. Do not use chemicals or abrasive elements. Under no circumstances allow moisture to penetrate the instrument. To avoid electrical shock, unplug the power cord from the AC outlet before cleaning.



WARNING

Electrical Shock Hazard!

**No operator serviceable parts inside.
Do not remove covers.**

Refer servicing to qualified personnel.

Abnormal Conditions

Operate the instrument only as intended by the manufacturer.

If you suspect the scope's protection has been impaired, disconnect the power cord and secure the instrument against any unintended operation.

The scope's protection is likely to be impaired if, for example, the instrument shows visible damage or has been subjected to severe transport stresses.

Proper use of the instrument depends on careful reading of all instructions and labels.



WARNING

Any use of the scope in a manner not specified by the manufacturer may impair the instrument's safety protection. The instrument and related accessories should not be directly connected to human subjects or used for patient monitoring.

BASIC CONTROLS

Front Panel Controls

The control buttons of the instrument's front panel are logically grouped into analog and special functional areas. Analog functions are included in the Horizontal, Trigger, and Vertical groups of control buttons and knobs.

Sometimes you may want to change a value without using the numeric keypad. In that case, simply touch once inside the data entry field in the scope dialog area (the field will be highlighted in yellow), then use the Adjust group of buttons and single knob to dial in values into the selected field.

By default, the control knob makes coarse adjustments (that is, digits to the left of the decimal point). Press the Fine button to adjust digits to the right of the decimal point. To enter exact values, you can also display a keypad by touching twice inside the data entry field. Then use the keypad to type in the value. The Select button steps through a dialog from one control to the next.



Example Data Entry Field

Note: You can set the granularity (delta) of the coarse adjustment in two ways:

- By pressing and holding the Fine front panel button while turning the Adjust knob. In this case you can read the changing

delta in the data entry field that is selected:

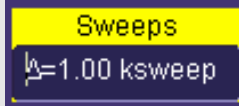



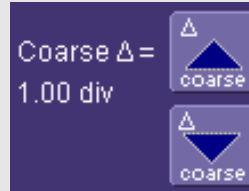



- By double-tapping inside the data entry field, then touching the **Advanced** checkbox in the pop-up numeric keypad. The

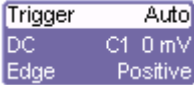



keypad presents **Coarse** delta up/down buttons to set the delta:

In the pop-up keypad, be sure to leave the **Fine** checkbox unchecked to adjust the coarse delta.

Trigger Knobs:	
<i>Level</i>	<p>Selects the trigger threshold level. The Level is indicated in the Trigger label:</p> 
Trigger Buttons:	
<i>Setup</i>	Activates the trigger setup menu to select the trigger type and the trigger conditions.
<i>Stop</i>	Prevents the scope from triggering on a signal. If you boot up the instrument with the trigger in Stop mode, the message "no trace available" will be displayed. Press Auto to display your trace.
<i>Auto</i>	Triggers the scope after a time-out, even if the trigger conditions are not met.
<i>Normal</i>	Triggers the scope each time a signal is present that meets the conditions set for the type of trigger selected.
<i>Single</i>	Arms the scope to trigger once (single-shot acquisition) when the input signal meets the trigger conditions set for the type of trigger selected. If the scope is already armed, it will force a trigger.
Horizontal Knobs:	
<i>Delay</i>	Horizontally positions the scope trace on the display so you can observe the signal prior to the trigger time. <i>Delay</i> adjusts the pre- and post-trigger time.
<i>Time/Division</i>	Sets the time/division of the scope timebase (acquisition system). LeCroy's SMART Memory feature automatically optimizes the memory and sample rate for maximum resolution.
Horizontal Buttons:	
<i>Smart Memory</i>	Calls up the SMART Memory dialog from the Horizontal setup menus.
<i>Zero Delay</i>	Sets the horizontal delay to zero. The trigger point is positioned in the middle of the display grid.
<i>Setup</i>	Activates the TIMEBASE menu to allow you to select acquisition conditions, including the sample mode, maximum memory length, etc.
Vertical Knobs:	
 <i>Offset</i>	Adjusts the vertical offset of a channel.

<i>Volts/Div</i>	Adjusts the Volts/Division setting (vertical gain) of the channel selected.
Channel Buttons:	
1, 2, 3, 4	Turns a channel on or off. These buttons activate the dialog that lets you change the channel's setup conditions including coupling, gain, and offset. They are used also to select multiple grids, to automatically set the gain (FIND SCALE), or to automatically display a zoom of the signal. Press twice to toggle the trace on and off.
Wavepilot Control Knobs:	
 <i>Position</i>	Adjusts the horizontal position of a zoom trace on the display. The zoom region is highlighted in color on the source trace.
 <i>Zoom</i>	Adjusts the horizontal zoom (magnification factor) of the selected zoom trace.
 <i>Position</i>	Adjusts the vertical position of the selected zoom trace on the display.
 <i>Zoom</i>	Adjusts the vertical zoom (magnification factor) of the selected zoom trace on the display.
Wavepilot Control Buttons:	
<i>Reset</i>	Resets the zoom factors.
<i>Math</i>	Provides access to the Math setup dialog.
Measure	Provides access to the Measure setup dialog.
Analysis	Provides access to the Analysis setup dialogs.
Special Features Buttons:	
<i>Auto Setup</i>	Automatically sets the scope's horizontal timebase (acquisition system), vertical gain and offset, as well as trigger conditions, to display a wide variety of signals.
Cursors	The center button calls up the "Standard Cursors" setup dialog. The other two buttons control the placement of the cursors on your waveform.
Default Setup	Sets the scope's horizontal timebase (acquisition system), vertical gain and offset, and trigger conditions to default settings.
Drive Analysis	This button is found on DDA instruments in place of Default Setup. When pressed, it displays the DDA setup dialogs.
Serial Data	This button is found on Serial Data Analyzers in place of Default Setup. When pressed, it displays the SDA setup dialogs.



Help	Displays the on-line Help manual. You can choose to receive control help, or to search for the information you need using the Table of Contents and Index. Control Help displays help for a particular button, menu item, data field, etc. contained in the dialogs.
Save/Recall	Calls up the dialogs for saving and recalling waveforms and setups, and for disk utilities.
<i>Analog Persist</i>	Provides a three dimensional view of the signal: time, voltage, and a third dimension related to the frequency of occurrence, as shown by a color-graded (thermal) or intensity-graded display.
<i>QuickZoom</i> 	Automatically displays magnified views of up to four signal inputs on multiple grids. With four input signals, the signals are displayed along with four zoom traces, each on its own grid. This button turns off all other traces.
General Control Buttons:	
<i>Print Screen</i> 	Prints the displayed screen to a file, a printer, the clipboard, or attaches it as an e-mail. Select the device and format it in the Utilities Hardcopy dialog.
<i>Utilities</i>	For setup of scope features including hardcopy devices and formats, date and time, and remote control interfaces, etc.; or for checking status, options, etc..
Touch Screen (toggle switch)	Activates or deactivates the touch screen.
<i>Clear Sweeps</i>	Clears data from multiple sweeps (acquisitions) including: persistence trace displays, averaged traces, parameter statistics, and Histicons. During waveform readout, cancels readout.
STANDBY Lamp:	The STANDBY lamp indicates when the scope has placed itself in standby mode. In this mode, current settings are retained.

On-screen Toolbars, Icons, and Dialog Boxes



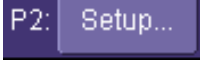

Menu Bar Buttons





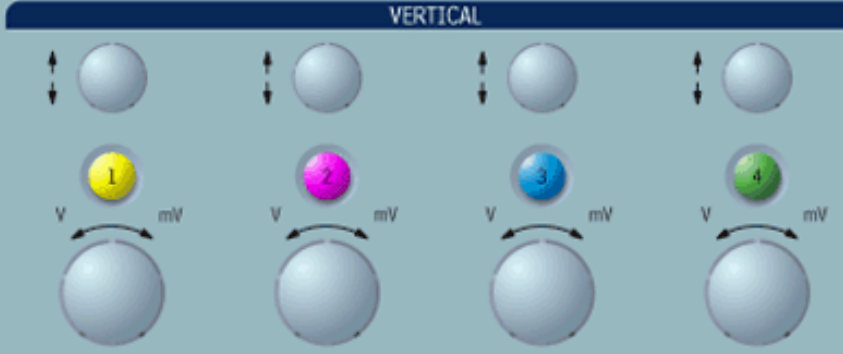

The menu bar buttons at the top of the scope's display are designed for quick setup of common functions. At the right end of the menu bar is a quick setup button that, when touched, opens the setup dialog associated with the trace or parameter named beside it. The named trace or

parameter is the one whose setup dialog you last opened: . This button also

appears as an undo button  after front panel buttons Autosetup and QuickZoom  are pressed. If you want to perform an Undo operation, it must be the very next operation after you perform the Autosetup or QuickZoom operation.

Many of the menu bar buttons give you access to the same functions as do the front panel buttons. Refer to this Table of Equivalent Functions.

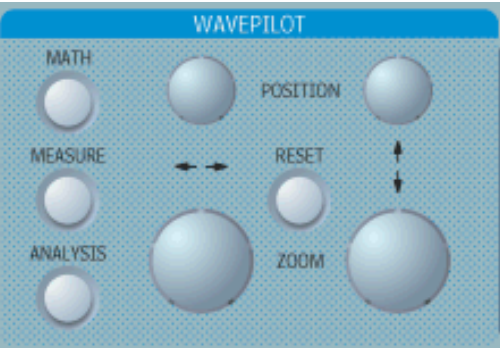
Display Buttons	Front Panel Push Buttons
	
	
	

<p>Trigger</p>	
<p>Cursors</p>	
<p> Zoom (icon in Channels dialog zooms one trace)</p>	 <p>(zooms all displayed traces)</p>
<p>Math (then Math Setup...)</p>	
<p>Measure (then Measure Setup...)</p>	
<p>Utilities (then Utilities Setup...)</p>	



Dialog Boxes

The dialog area occupies the bottom one-third of the screen. To expand the signal display area, you can minimize each dialog box by touching the **Close** tab at the right of the dialog box.

Alternate Access Methods

The instrument often gives you more than one way to access dialogs and menus.







Mouse and Keyboard Operation

In the procedures we focus on touch-screen operation, but if you have a mouse connected to the instrument, you can also click on objects. Likewise, if you have a keyboard connected, you can use it instead of the virtual keyboard provided by the instrument.

If you want to connect a mouse to the instrument, use only a USB mouse.

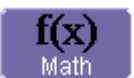
Tool Bar Buttons

The procedures also focus on the use of the menu bar at the top of the screen to access dialogs and menus. However, on several dialogs common functions are accessible from a row of buttons that save you a step or two in accessing their dialogs. For example, at the bottom of the Channel Setup dialog, these buttons perform the following functions:

	Calls up the Measure menu. You can then select a parameter from this menu without leaving the Channel Setup dialog. The parameter automatically appears below the grid.
	Creates a zoom trace of the channel trace whose dialog is currently displayed.
	Calls up the Math menu. You can then select a math function from this menu without leaving the Channel Setup dialog. A math trace of the channel whose dialog is currently open is automatically displayed.
	Loads the channel trace into the next available memory location (M1 to M4).
	Automatically performs a vertical scaling that fits the waveform into the grid.
	Automatically moves the channel trace whose dialog is currently open onto the next grid. If you have only one grid displayed, a new grid will be created automatically, and the trace moved.

Another example is these buttons that appear at the bottom of the Measure **Px** dialogs. Each button opens a menu from which to choose a math trace (F1 to Fx [The number of math traces available

depends on the software options loaded on your scope. See specifications.]) to display the



functions named in the buttons: Histogram, Trend, Track. By using these buttons you can remain in the Measure dialog to set up other options.

Trace Descriptors

Vertical and horizontal trace descriptors (labels) are displayed below the grid. They provide a summary of your channel, timebase, and trigger settings. To make adjustments to these settings, touch the respective label to display the setup dialog for that function.

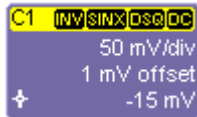

Channel trace labels show the vertical settings for the trace, as well as cursor information if cursors are in use. In the title bar of the label are also included indicators for (SinX)/X interpolation, waveform inversion (INV), deskew (DSQ), coupling (DC/GND), bandwidth limiting (BWL), and averaging (AVG). These indicators have a long and short form

AVG	A
SINX	S
INV	I
DSQ	DS
DC	D
Gnd	G
BwL	B

Besides channel traces, math and parameter measurement labels are also displayed. Labels are displayed only for traces that are turned on.

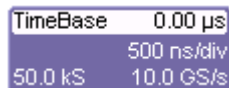

The title bar of the **TimeBase** label shows the trigger delay setting. Time per division and sampling information is given below the title bar.

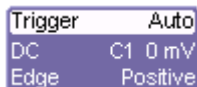

The title bar of the **Trigger** label shows the trigger mode: Auto, Normal, or Stopped. Below the title bar is given the coupling (DC), trigger type (Edge), source (C1), level (0 mV), and slope (Positive).



Shown below the TimeBase and Trigger labels is setup information for horizontal cursors, including the time between cursors and the frequency.

Trace Annotation

The instrument gives you the ability to add an identifying label, bearing your own text, to a waveform display:

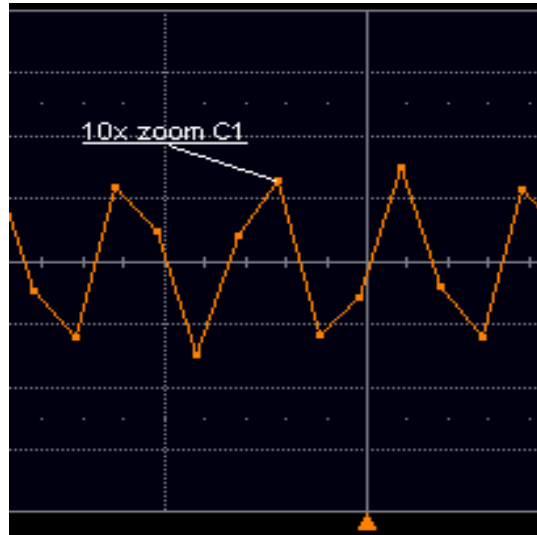

For each waveform, you can create multiple labels and turn them all on or all off. Also, you can position them on the waveform by dragging or by specifying an exact horizontal position.

To Annotate a Waveform

1. Touch the waveform you want to annotate, then **Set label...** in the pop-up menu. A dialog box opens in which to create the label. If you are creating a label for the first time for this waveform, **Label1** is displayed with default text. If you are modifying an existing label, under **Labels** touch the label you want to change.

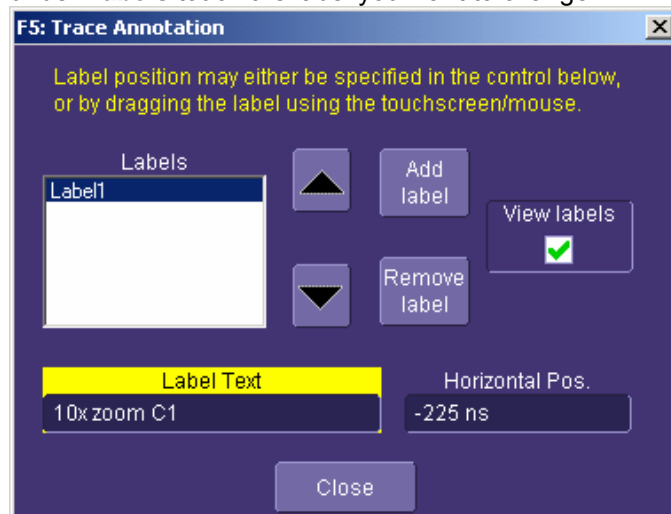



Note 1: If the dialog for the trace you want to annotate is currently displayed, you can touch the label button at the bottom to display the Trace Annotation setup dialog.

Note 2: You may place a label anywhere you want on the waveform. Labels are numbered sequentially according to the order in which they are added, and not according to their placement on the waveform.

2. If you want to change the label's text, touch inside the **Label Text** field. A pop-up keyboard appears for you to enter your text. Touch **O.K.** on the keyboard when you are done. Your edited text will automatically appear in the label on the waveform.
3. To place the label precisely, touch inside the **Horizontal Pos.** field and enter a horizontal value, using the pop-up numeric keypad.
4. To add another label, touch the **Add label** button. To delete a label, select the label from the list, then touch the **Remove label** button.
5. To make the labels visible, touch the **View labels** checkbox.

To Turn On a Channel Trace Label

Note: If you want to display each trace on its own grid automatically, enable Autogrid by touching **Display** in the menu bar, then **Autogrid** in the drop-down menu.

- On the front panel, press a channel select button, such as , to display the trace label for that input channel and turn on the channel.
- To turn on a math function trace, touch **Math** in the menu bar, then **Math Setup...** in the drop-down menu. Touch the **On** checkbox for the trace you want to activate.
- You can also quickly create traces (and turn on the trace label) for math functions and memory traces, without leaving the Vertical Adjust dialog, by touching the icons at the

bottom of the Vertical Adjust dialog:



Whenever you turn on a channel, math, or memory trace via the menu bar, the dialog at the bottom of the screen automatically switches to the vertical setup or math setup dialog for that selection. You can configure your traces from here, including math setups.



C1 Vertical Adjust

The channel number appears in the Vertical Adjust tab of the "Vertical Adjust" dialog, signifying that all controls and data entry fields are dedicated to the selected trace.

Screen Layout

The instrument's screen is divided into three areas:

- menu bar
- signal display area

- dialog area

Menu Bar

The top of the screen contains a toolbar of commonly used functions. Whenever you touch one of these buttons, the dialog area at the bottom of the screen switches to show the setup for that function.

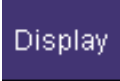

Signal Display Grid





You can set up the signal display area by touching  in the toolbar, then the



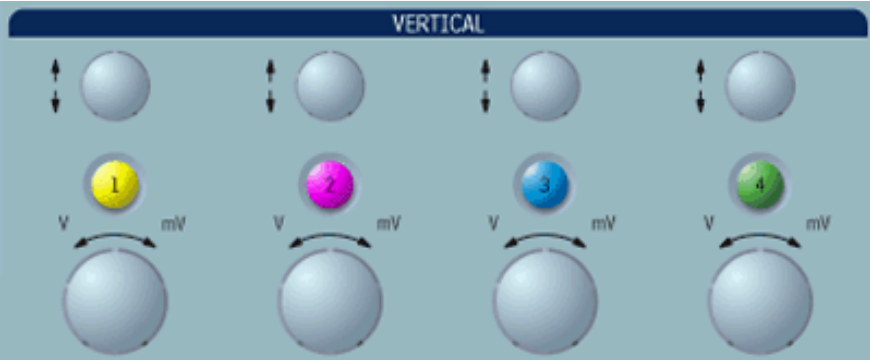

 tab. The display dialog offers a choice of grid combinations and a means to set the grid intensity.

Dialog Area

The lower portion is where you make selections and input data. The dialog area is controlled by both toolbar touch buttons and front panel push buttons. Similarities between functions are shown in this Table of Equivalent Functions.

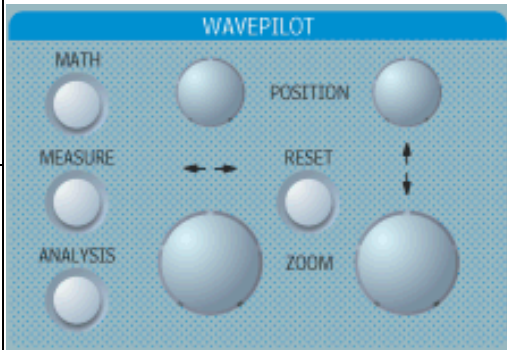
<p>Timebase</p>	 <p>The HORIZONTAL control panel features a 'POSITION' knob with a double-headed arrow above it, a 'ZERO' button, a 'SMART MEMORY' button, a 'SETUP' button, and a large knob with 's' and 'ns' labels and a double-headed arrow above it.</p>
<p>Trigger</p>	 <p>The TRIGGER control panel includes a 'LEVEL' knob with a vertical double-headed arrow, an 'AUTO' button, a 'NORMAL' button, 'READY' and 'TRIG'D' status indicators, and 'SETUP', 'STOP', and 'SINGLE' buttons.</p>
<p>Cursors</p>	 <p>The CURSORS control panel contains three vertically stacked knobs.</p>
<p> Zoom (icon in Channels dialog zooms one trace)</p>	<p> (zooms all displayed traces)</p>

<p>Math</p> <p>(then Math Setup...)</p>	
<p>Measure</p> <p>(then Measure Setup...)</p>	
<p>Utilities</p> <p>(then Utilities Setup...)</p>	
<p>Help</p>	

INSTALLATION

Hardware

Instrument Rear Panel

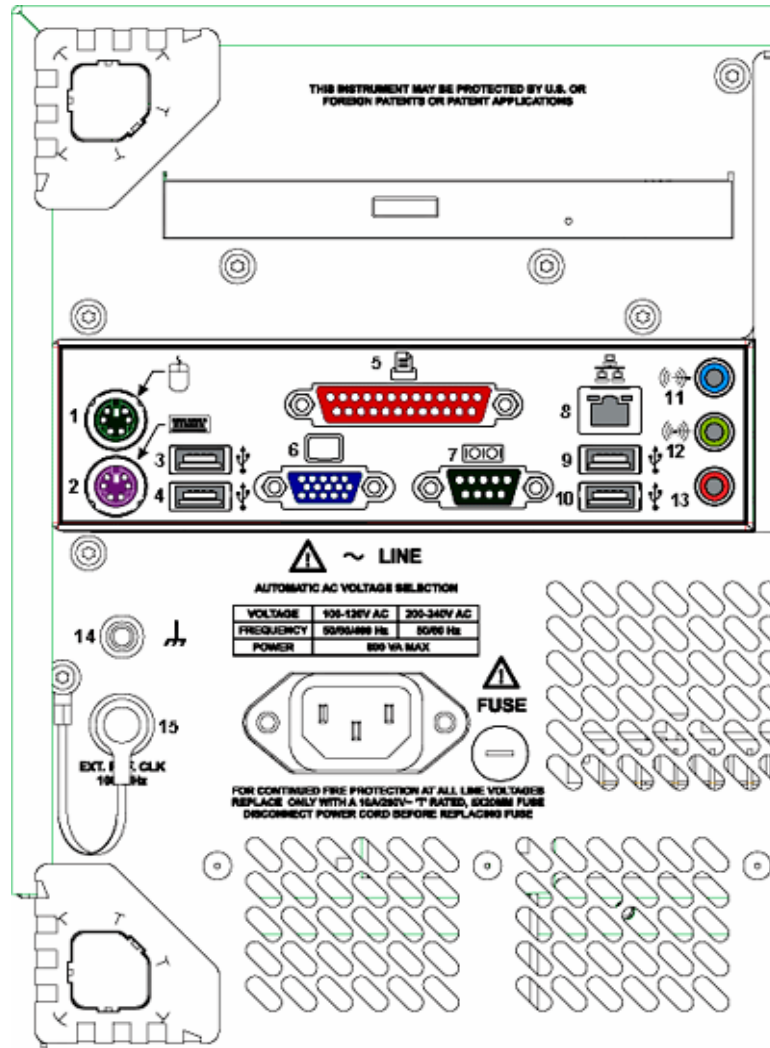

(1) Mouse; (2) Keyboard; (3) USB Port; (4) USB Port; (5) Centronics Port; (6) External VGA Monitor; (7) RS-232-C Port; (8) Ethernet Port; (9) USB Port; (10) USB Port; (11) Line In; (12) Speakers; (13) Microphone; (14) Ground Connector; (15) External Clock Input with Grounded EMI Shield installed (required when port is not in use)

Software

Checking the Scope Status

To find out the scope's software and hardware configuration, including software version and

installed options, proceed as follows:

1. In the menu bar, touch .

2. Touch the  tab.

You can find information related to hard drive memory, etc. as follows:

1. Minimize the instrument application by touching , then selecting **Minimize** in the drop-down menu.
2. Touch the **Start** taskbar button and, per usual Windows® operation, open Windows Explorer.

Loading Software Upgrades

You can download software upgrades from the LeCroy Web site at www.lecroy.com. Follow the on-screen instructions to download the software. Click the *Release Notes* link to learn about new features and fixes.

Default Settings

WaveMaster and WavePro 7000A Series Scopes

You can reset the scope to default settings by simply pressing the Default Setup push button



on the front panel. This feature turns on Channel 1 and Channel 2, with no processing enabled.

Other default settings are as follows:

Vertical	Timebase	Trigger
50 mV/div	50.0 ns/div	Coupling: DC (WaveSurfer), DC50 (WaveMaster, DDA, SDA), AC1M (WavePro) Channel: C1 Level: 0 mV
0 V offset	10.0 GS/s (WaveMaster, WavePro, DDA, SDA) 5 GS/s (WaveRunner) 1 GS/s (WaveSurfer)	edge trigger positive edge
	0 s delay	Auto trigger mode

DDAScopes

On your front panel, the Default Setup push button does not exist. For these instruments, therefore, to recall a default setup

1. Press the Save/Recall push button to the left of the Drive Analysis push button.

Note: You can also touch **File** in the menu bar, then **Recall Setup...** in the drop-down menu.



2. Touch the "Recall Setup" tab in the dialog.
3. Then touch the on-screen **Recall Default** button:



Adding a New Option

To add a software option you need a key code to enable the option. Call LeCroy Customer Support to place an order and receive the code.

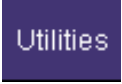
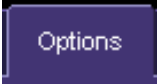
To add the software option do the following:

1. In the menu bar, touch .
2. In the dialog area, touch the  tab.
3. Touch .
4. Use the pop-up keyboard to type the key code. Touch **O.K.** on the keyboard to enter the information.
5. The name of the feature you just installed is shown below the list of key codes. You can use the scroll buttons to see the name of the option installed with each key code listed:

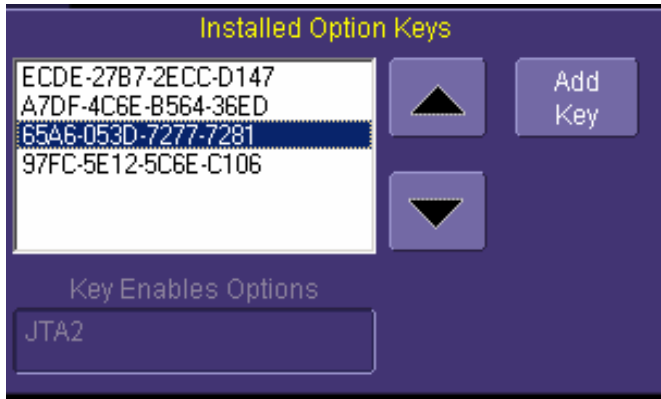

The full array of installed software and hardware options is displayed on the left side of the dialog:

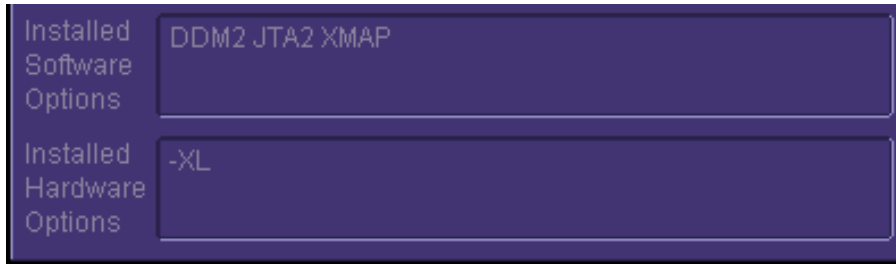

RESTORING SOFTWARE

Using the Recovery Disk – non-Windows XP Scopes

Your oscilloscope comes with a recovery disk to be used in the event that it becomes necessary to reload the operating software. Follow the instructions displayed on-screen when loading the recovery software.

System Recovery – Windows XP Scopes

Your oscilloscope was designed to operate very reliably for many years. However, the application software that operates the instrument runs on a Windows platform. The loading or incomplete removal of additional Windows applications may eventually cause problems in the stability of the operating system. In severe cases, it may be necessary to reload the base operating system and oscilloscope application. This can be done by using a recovery routine to restore a clean copy of the image originally installed on the C: drive. Any user data and calibration data located within the D: partition will not be affected by the recovery process.

LeCroy has provided a recovery application, along with a backup image, in an extra partition on the instrument's hard drive. The recovery process is easy to perform, using the instructions provided below.

After the recovery procedure is done, you must activate Windows, either by internet connection to Microsoft's Web site or by telephone. For this you will need to supply the Windows Product Key number, which is affixed to the rear of the scope.

Note: The recovery process will produce a replica of the operating system and oscilloscope application software to the revision levels that were current at the time the oscilloscope was manufactured. Any further revisions of the application software, Windows operating system, and virus scan definition files will not be upgraded automatically. After completion of the disk image recovery, it is highly recommended that you search the vendors' Web sites to upgrade the individual components to their current revision level. The current oscilloscope application software can be downloaded directly from the LeCroy Web site at www.lecroy.com.

Since the calibration data for the oscilloscope is stored in the D: drive, the current calibration constants will not be overwritten during the recovery process.

Recovery Procedure

1. Connect an network cable to the LAN port at the rear of the scope if you intend to activate windows through the internet.
2. Connect a keyboard and a mouse to the scope.
3. Apply power to the scope.

- As soon as the LeCroy logo appears on the screen, press and hold down the **F4** key until the recovery software logo appears momentarily:



- Then the cME console End User License Agreement is displayed. Read the agreement, and click **Accept**:

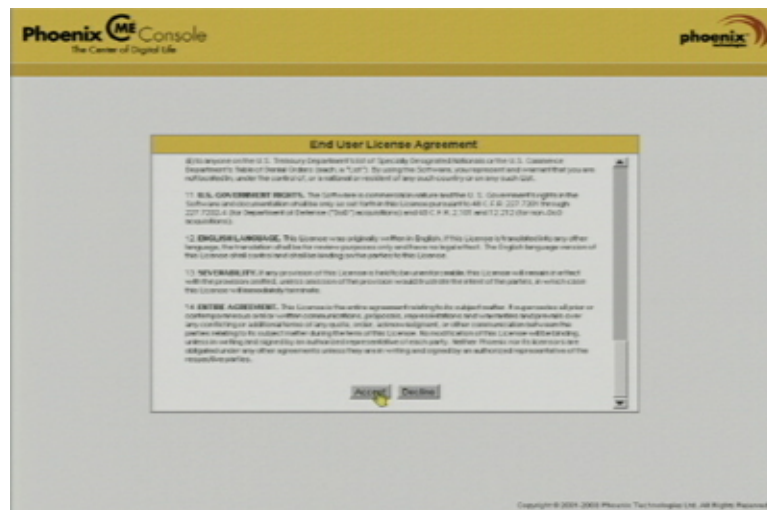

6. The Phoenix cME Console main page is displayed. Click **Click here to start recover:**

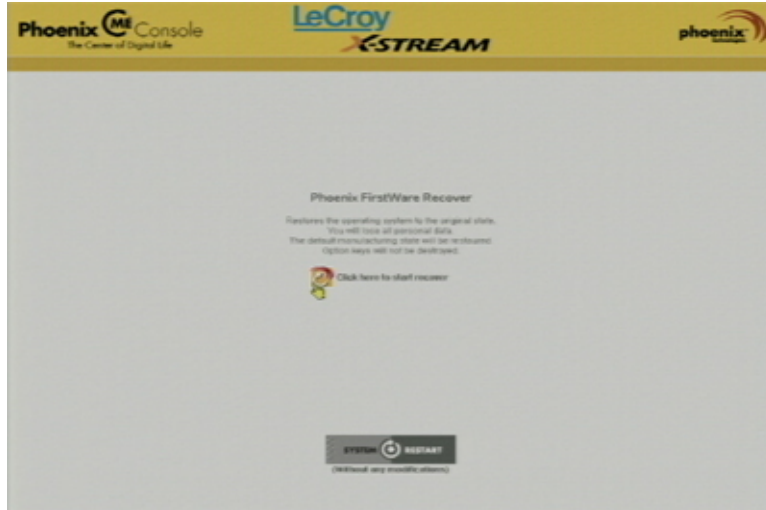

7. The FirstWare Recover splash screen is displayed momentarily:

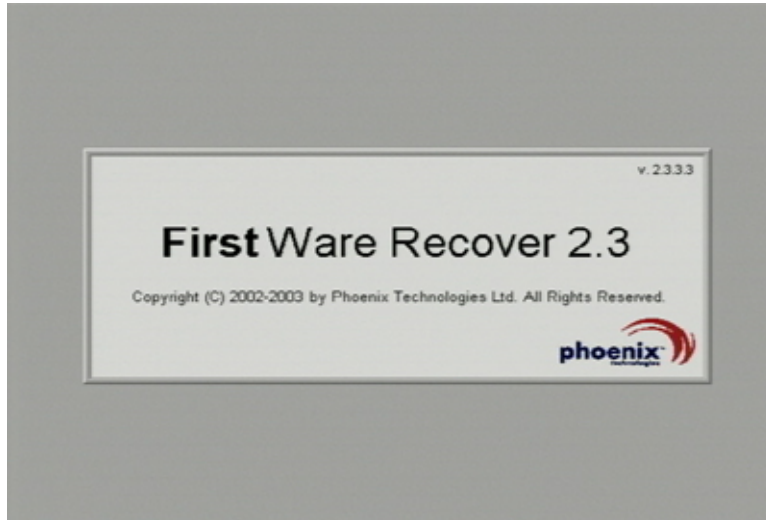

- The recovery starts, and the FirstWare Progress screen is displayed. No further selections are required. The recovery takes about 10 minutes.

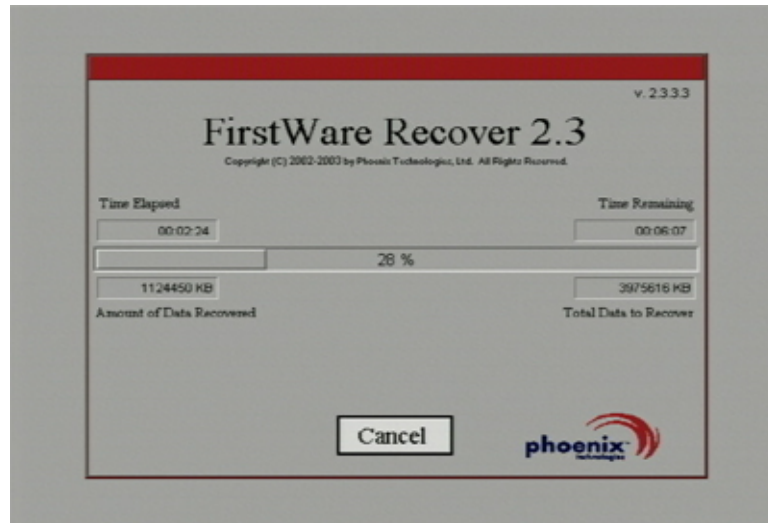

Note: The screen will blank on occasion for prolonged periods. This is normal and is not an indication of any malfunctioning of the recovery process.

- After the recovery is completed, the X-Stream software installer screen appears. Click **Next** to continue:



- When the X-Stream installation is completed, reboot the scope.

Now you must activate Windows by internet connection to Microsoft's Web site or by telephone. For this you will need to supply the Windows Product Key number, which is affixed to the rear of the

scope.

Windows Activation

1. Click **Start** in the task bar, then select **All Programs** → **Activate Windows**.

Note: After Windows Activation is completed, this selection will no longer appear in the All Programs menu.

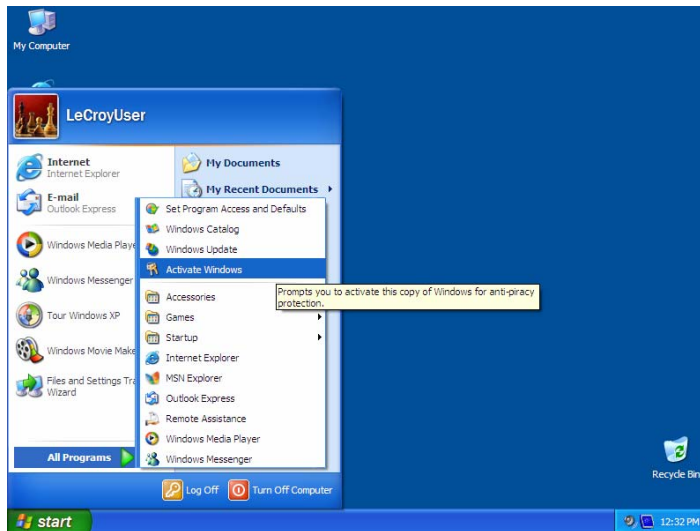

2. Select an activation method: internet or phone. Then click **Next**.

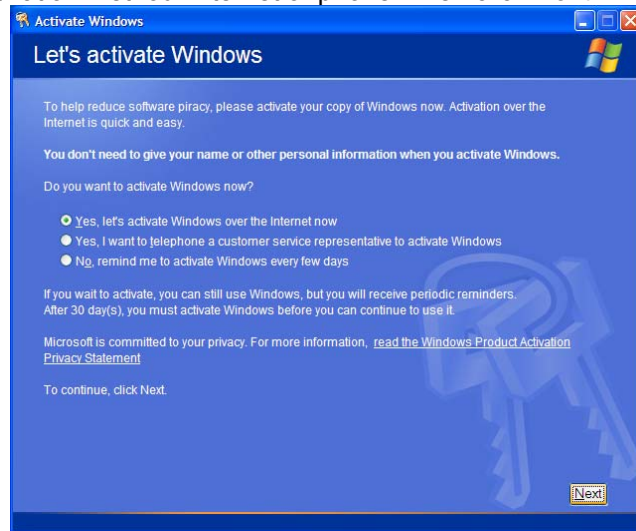

3. If you elected to activate by internet, enter the Activation ID (Product Key) number when prompted to do so, then click **Next**. Windows Activation will begin.
4. If you elected to activate by phone, select the country the scope is located in. Then dial the number provided. You will be asked to repeat over the phone the installation ID listed on

the screen; then a 7-part number will be provided to you to enter in the empty boxes at the bottom of the screen. Click **Next** when you are done.



5. When activation is completed, an acknowledgement screen will appear. Click **OK**.

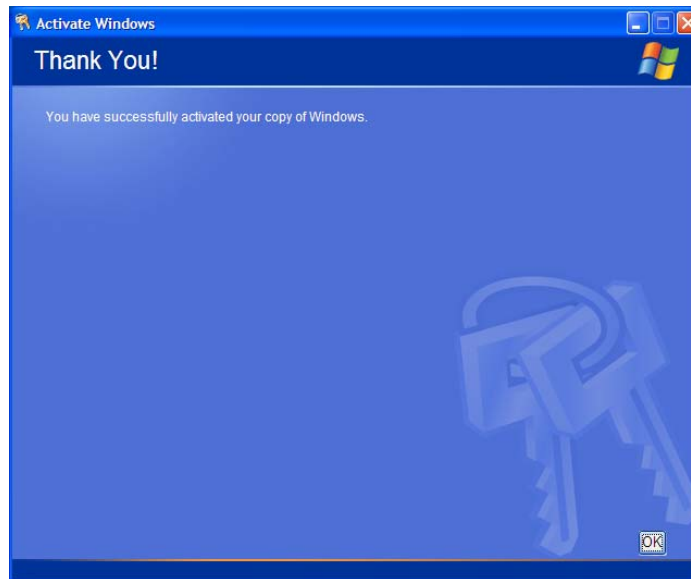

6. Check the revision levels of the X-Stream software, virus definitions, and Windows updates. Visit the vendors' Web sites and download all necessary updates.

Restarting the Application

Upon initial power-up, the scope will load the instrument application software automatically. If you



exit the application and want to reload it, touch the shortcut icon on the desktop:

If you minimize the application, touch the appropriate task bar or desktop button to maximize it:



Restarting the Operating System

If you need to restart the Windows® operating system, you will have to reboot the scope by pressing and holding in the power switch for 10 seconds, then turning the power back on.

Removable Hard Drive

The removable hard drive option replaces the standard internal hard drive with a removable hard drive that is installed at the rear of the scope, in the slot normally occupied by the CDROM drive. The kit includes two hard drives, which can be used interchangeably. It also includes a USB CDROM for loading of new software.



Caution

The Removable Hard Drive Is Not Hot-swappable

To avoid damage to the drive or the oscilloscope, shut off power to the oscilloscope before you insert or remove the hard drive. Ensure that the protective cover is installed over the drive at all times.



Proper Orientation of Drive



Protective Cover

External Monitor

If your X-Stream scope's processor runs at greater than 1 GHz, the external monitor must be configured manually. You can find out your processor's speed by touching **Utilities** in the menu bar, then touching the **Status** tab of the "Utilities" dialog. If the speed is greater than 1 GHz, proceed as follows:

1. Connect the external monitor to the VGA port at the rear of the instrument (item 6 in the diagram).

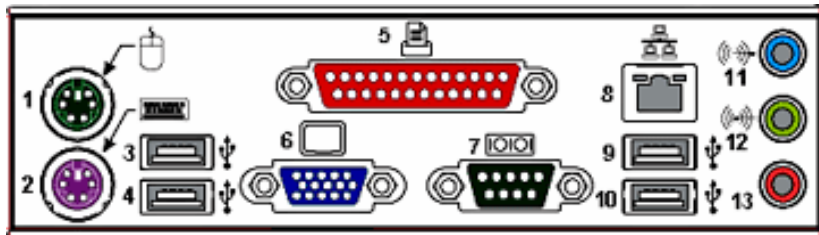

2. Plug in the monitor's power cord, and apply power to the monitor.
3. After boot-up, touch **Display** in the menu bar, then **Display Setup...** in the drop-down menu.
4. Touch the **Monitor** tab of the "Display" dialog:

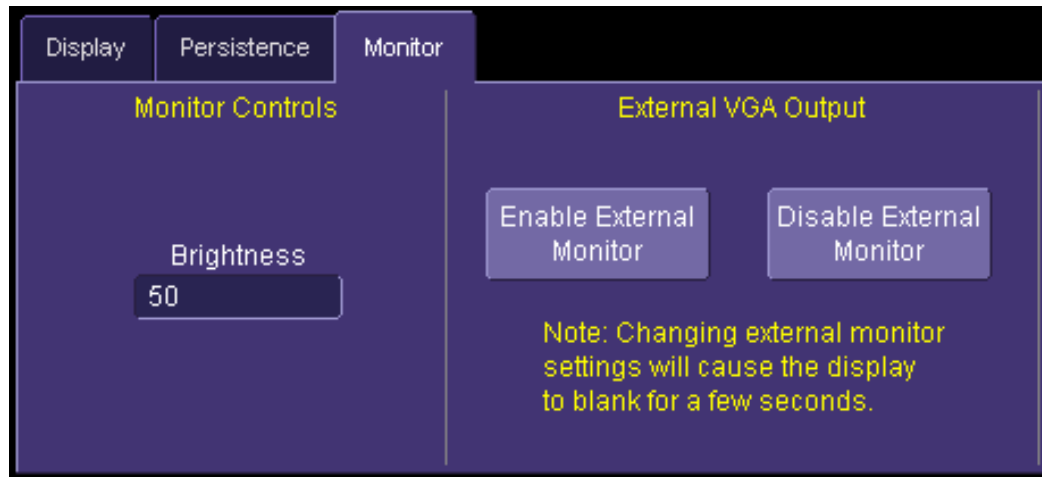

5. Touch **Enable External Monitor**.
6. Touch inside the **Brightness** field and adjust brightness as necessary.

Writable CD Drive option

If your scope is equipped with this option, follow these setup instructions to install the software.

Note: Install the software only in scopes that have CD drive model SM-CD-W224EA installed.

1. Connect a keyboard and mouse to the scope.
2. Load the **Easy CD Creator 5 Basic** installation CD into the CD drive.
3. Click **Yes** to begin installation:

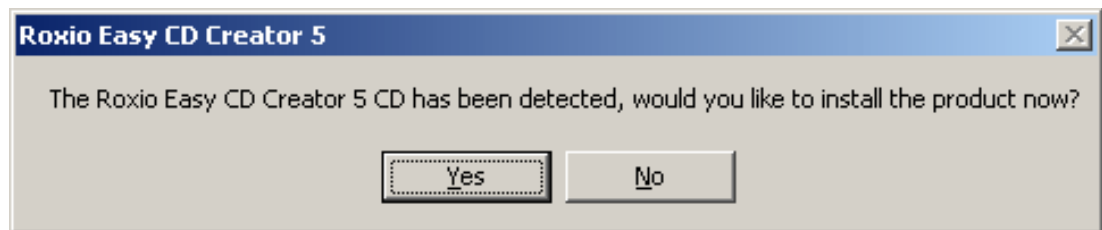

4. Select a language:

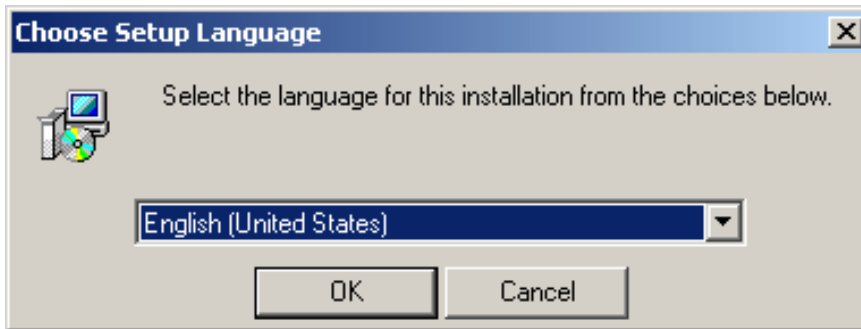

5. Click **Next** when the Wizard appears:

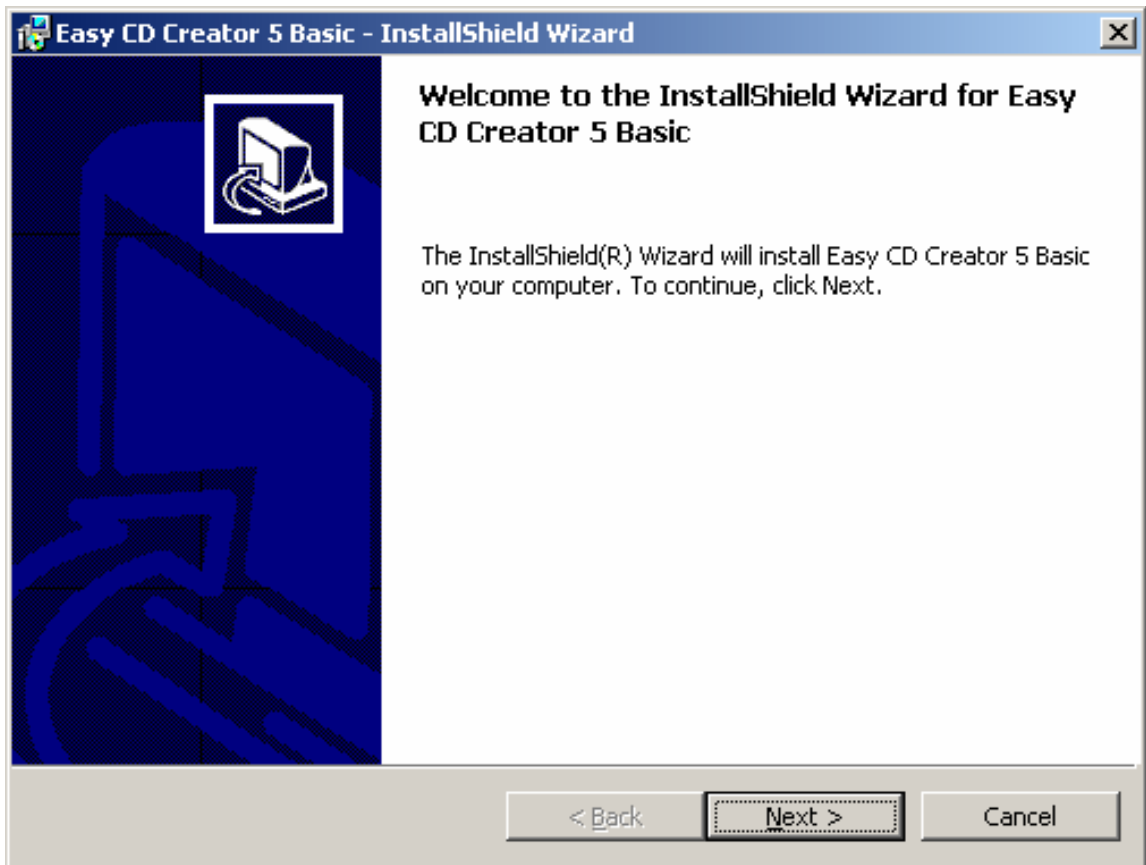

6. Select **Complete** setup:

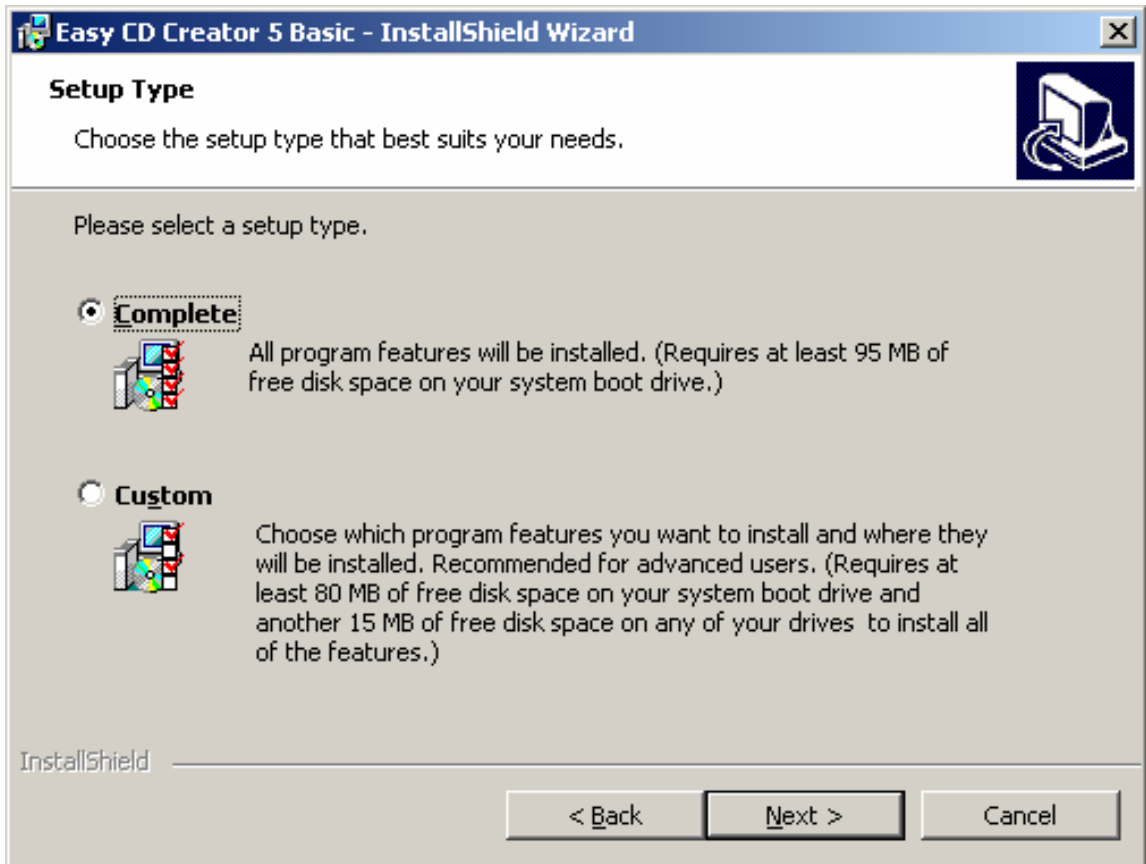

7. Click **Install**:

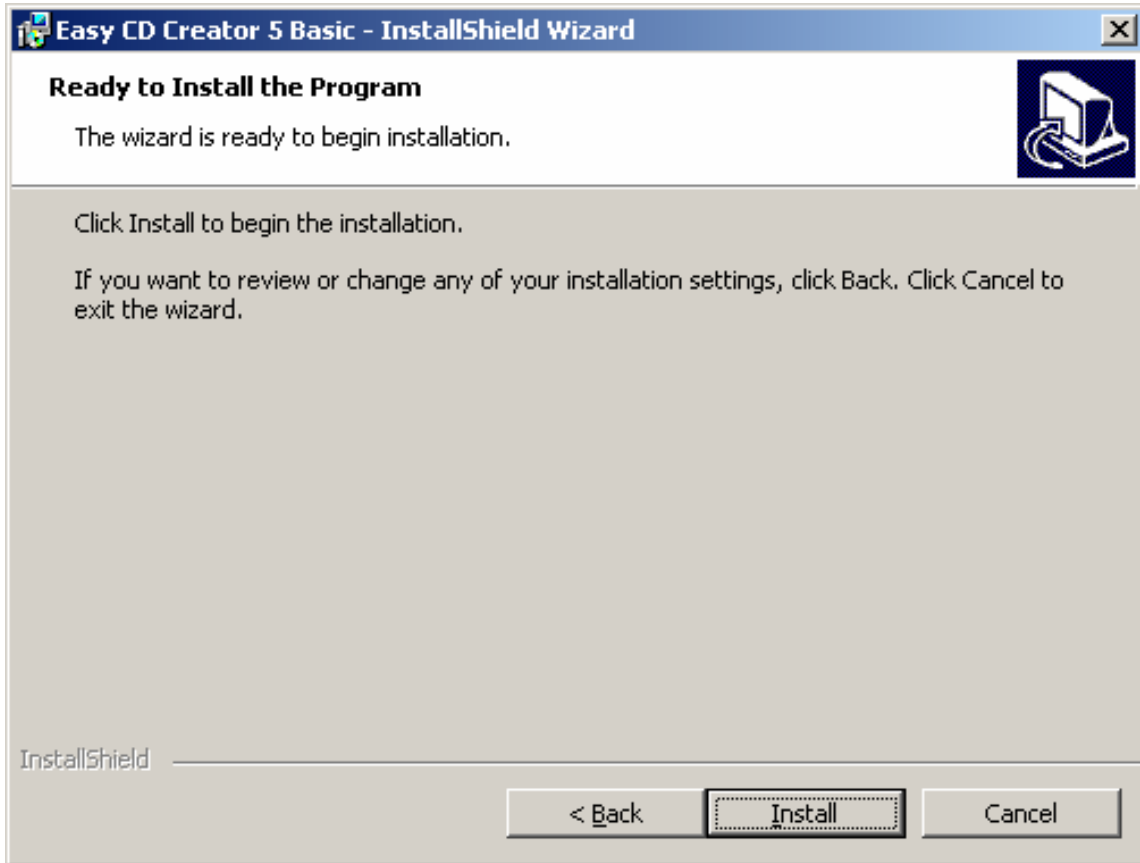

8. When installation is completed, the scope will need to be rebooted.

The install Wizard places a shortcut icon on the desktop.

Note: If in the future it is necessary to run recovery software, this **Easy CD Creator 5 Basic** installation software will need to be reinstalled also.

CONNECTING TO A SIGNAL

ProLink Interface

LeCroy's ProLink Adapters (LPA) give you the ability to connect your signal in one of three ways:

- BMA connector
- SMA using the BMA-to-SMA adapter
- BNC using BMA-to-BNC adapter



(1) BMA-to-SMA Adapter; (2) BMA-to-BNC Adapter



(1) BMA Female Connector; (2) ProLink BMA-to-SMA Adapter Installed; (3) ProLink BMA-to-BNC Adapter Installed

Note: When connecting an active probe to the instrument, be sure to use a ProLink BMA-to-BNC adapter (item 3 in the figure). Do not plug the probe directly into the front panel connector (item 1) without an adapter.

Connecting the Adapters

The mating end of the ProLink adapter has four fastening clips, as shown here:



When installing an adapter on the instrument's connector panel, align the male 6-pin connector with the female connector and push the adapter straight in. There will be some resistance and you'll hear clicks as the four clips slide into place. Then tighten the captive screws.

When removing an adapter, loosen the two captive screws. Push down on the adapter to unseat the clips. This will require some force and will be initially noisy, but no damage will result to the connector, the floating female BMA connector, or the pins, which can be 15 degrees off axis when being mated or unmated.

ProBus Interface

LeCroy's ProBus® probe system provides a complete measurement solution from probe tip to oscilloscope display. ProBus allows you to control transparent gain and offset directly from your front panel. It is particularly useful for voltage, differential, and current active probes. It uploads gain and offset correction factors from the ProBus EPROMs and automatically compensates to achieve fully calibrated measurements.

This intelligent interconnection between your instrument and a wide range of accessories offers important advantages over standard BNC and probe ring connections. ProBus ensures correct input coupling by auto-sensing the probe type, thereby eliminating the guesswork and errors that occur when attenuation or amplification factors are set manually.

AP-1M Hi-Z Adapter





The AP-1M adapter provides a means to connect a high-impedance input to your instrument. In order to achieve high bandwidth with excellent signal integrity, these instruments have a ± 4 V dynamic range and 50 Ω termination to ground. However, for applications that combine one or more high-speed signals with slower, higher-voltage signals, the AP-1M provides a 1 M input impedance path and a full-scale range of ± 8 V. It is also suitable as an interface for current probes that require a 1 M input path.



In addition to acting as a ProLink-to-ProBus adapter, the AP-1M also enables a much larger offset voltage range (up to ± 50 V).

The AP-1M is supplied with a PP005A passive probe.

Auxiliary Output Signals

In addition to a calibration signal, the following signals can be output through the AUX OUTPUT connector:

	Square Wave
	Trigger Out -- can be used to trigger another scope
	DC level -- a reference level



	Trigger Enabled -- can be used as a gating function to trigger another instrument when the scope is ready
	Pass/Fail -- allows you to set a pulse duration from 1 ms to 500 ms; generates a pulse when pass/fail testing is active and conditions are met.
	Aux Output Off -- turns off the auxiliary output signal

To Set Up Auxiliary Output

1. In the menu bar, touch **Utilities**, then **Utilities Setup...** in the drop-down menu.
2. Touch the **Aux Output** tab.
3. If you simply want a 1 kHz, 1 V square wave, touch the button so labeled.
4. If you want a specialized output, touch one of the buttons under **Use Auxiliary Output For**.
5. Touch inside the **Amplitude** data entry field and enter a value, using the pop-up numeric keypad. If you want a TTL level signal, touch the **TTL Level** checkbox. The **Amplitude** field will accordingly become unavailable.
6. If you selected Square Wave, touch inside the **Frequency** data entry field and enter a value, using the pop-up keypad. You can set a value from 5.0 Hz to 5 MHz.
7. If you selected Pass/Fail, touch inside the **Pulse Duration** field and enter a value from 1 ms to 500 ms, using the pop-up numeric keypad.

SAMPLING MODES

Depending on your timebase, you can choose either Single-shot (Real Time) , Sequence

, or RIS  mode sampling.

To Select a Sampling Mode

1. In the menu bar, touch **Timebase**, then **Horizontal Setup...** in the drop-down menu.
2. In the "Horizontal" dialog, touch a **Sample Mode** button.
3. If you chose **Sequence Mode**, touch the "Smart Memory" tab, then touch inside the **Num**

Segments data entry field  and enter a value, using the pop-up numeric keypad.

4. If you want to use a timeout condition for Sequence mode, touch the **Enable Timeout**

checkbox; then touch inside the **Timeout** data entry field  and enter a value, using the pop-up numeric keypad.

Single-shot sampling mode

Basic Capture Technique

A single-shot acquisition is a series of digitized voltage values sampled on the input signal at a uniform rate. It is also a series of measured data values associated with a single trigger event. The acquisition is typically stopped a defined number of samples after this event occurs: a number determined by the selected trigger delay and measured by the timebase. The waveform's horizontal position (and waveform display in general) is determined using the trigger event as the definition of time zero.

You can choose either a pre- or post-trigger delay. Pre-trigger delay is the time from the left-hand edge of the display grid forward to the trigger event, while post-trigger delay is the time back to the event. You can sample the waveform in a range starting well before the trigger event up to the moment the event occurs. This is 100% pre-trigger, and it allows you to see the waveform leading up to the point at which the trigger condition was met and the trigger occurred. (The instrument offers up to the maximum record length of points of pre-trigger information.) Post-trigger delay, on the other hand, allows you to sample the waveform starting at the equivalent of 10,000 divisions after the event occurred.

Because each instrument input channel has a dedicated ADC (Analog-to-Digital Converter), the voltage on each is sampled and measured at the same instant. This allows very reliable time measurements between the channels.

On fast timebase settings, the maximum single-shot sampling rate is used. But for slower timebases, the sampling rate is decreased and the number of data samples maintained.

The relationship between sample rate, memory, and time can be simply defined as:

$$\text{Capture Interval} = \frac{1}{\text{Sample Rate}} \times \text{Memory}$$

and

$$\frac{\text{Capture Interval}}{10} = \text{Time Per Division}$$

Sequence SAMPLING Mode Working With Segments

In sequence mode, the complete waveform consists of a number of fixed-size segments acquired in single-shot mode (see the instrument specifications for the limits). Select the number of segments to be captured, then select each segment individually and use it for processing with math and measure tools.

Sequence mode offers a number of unique capabilities. With it, you can limit dead time between trigger events for consecutive segments. The instrument can capture in fine detail complicated sequences of events over large time intervals, while ignoring the uninteresting periods between the events. You can also make time measurements between events on selected segments using the full precision of the acquisition timebase.

Each individual segment can be zoomed or used as input to math functions.

The instrument uses the sequence timebase setting to determine the capture duration of each segment: 10 x time/div. Along with this setting, the scope uses the desired number of segments, maximum segment length, and total available memory to determine the actual number of samples or segments, and time or points. However, the display of the complete waveform with all its segments may not entirely fill the screen.

You can also use Sequence mode in remote operation to take full advantage of the instrument's high data-transfer capability.

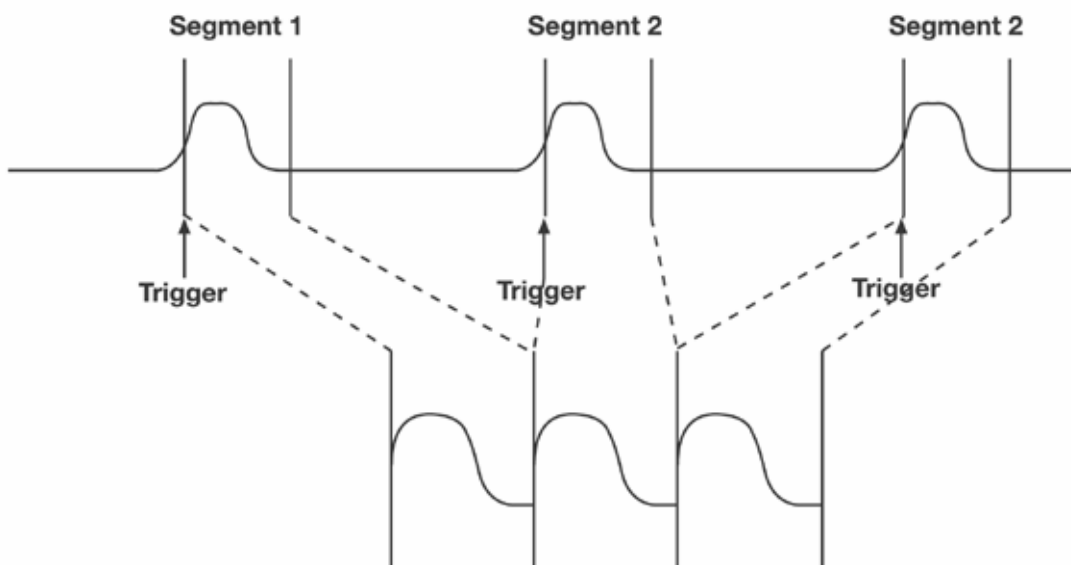

How the instrument captures segments

To Set Up Sequence Mode

1. In the menu bar, touch **Timebase**, then touch **Horizontal Setup...** in the drop-down menu.



2. Touch the **Smart Memory** tab, then touch the **Sequence** mode button.
3. Under **Sequence Options**, touch inside the **Num Segments** data entry field and enter the number of segments you want to display, using the pop-up keypad.
4. Touch inside the **Timeout** data entry field and enter a timeout value.

Note: The timeout period accounts for instances when a **Num Segments** miscount occurs for some reason and the scope waits indefinitely for an unforthcoming segment. During that time, no scope functions are accessible. By means of a timeout value, however, the acquisition will be completed, the waveform displayed, and control of the scope returned to the user after the timeout has elapsed.

5. Touch the **Enable Timeout** checkbox.
6. In the menu bar, touch **Display**, then **Display Setup...** in the drop-down menu.
7. At the far right of the "Display" dialog, touch inside the **Display mode** field, and make a selection from the pop-up menu.
8. Touch inside the **Num seg displayed** field and enter a value from 1 to 80, using the pop-up numeric keypad.

9. Touch inside the **Starting at** field and enter a starting segment number, using the pop-up numeric keypad.

Sequence Display Modes

The instrument gives you a choice of five ways to display your segments:

- Adjacent

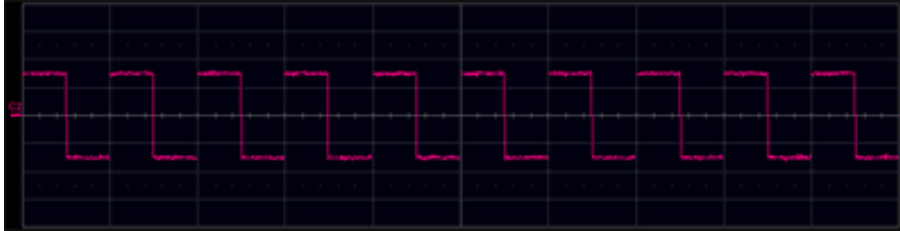

- Waterfall (cascaded)

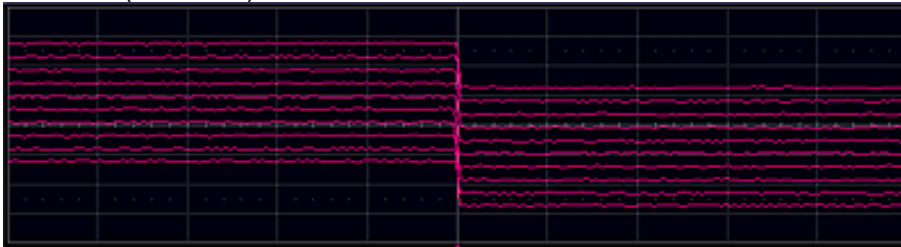

- Mosaic (tiled)

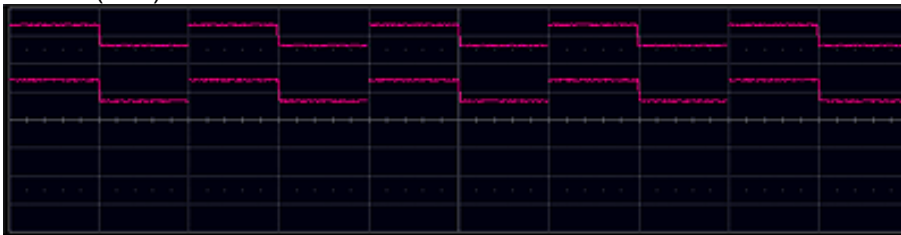

- Overlay

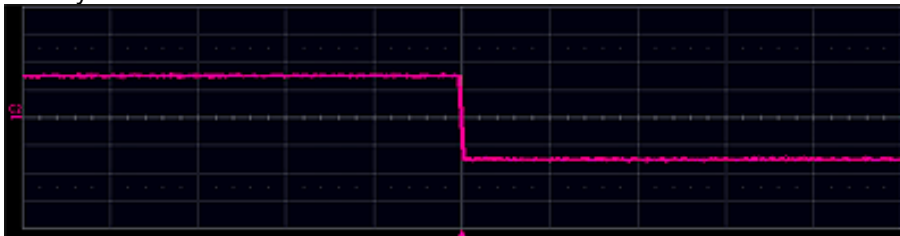

- Perspective

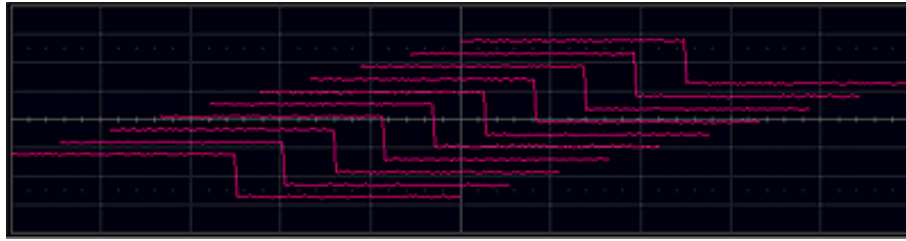

The number of segments you choose to display (80 maximum) can be less than the total number of segments in the waveform. For example, in the pop-up images above, the number of display segments is 10, but the total number of segments entered in the timebase dialog's **Num Segments** field is 100.

To Display Individual Segments

1. Touch **Math** in the menu bar, then **Math Setup...** in the drop-down menu.
2. Touch a function tab (**F1** to **Fx** The number of math traces available depends on the software options loaded on your scope. See specifications.).
3. Touch inside the **Operator1** field and select **Segment**  from the pop-up menu.
4. In the right-hand dialog, touch the **Select** tab.
5. Touch inside the **Select** data entry field and use the pop-up numeric keypad to select the segment you want to display.

Note: In Persistence mode, the segments are automatically overlaid one on top of the other in the display. In non-Persistence mode, they appear separately on the grid.

To View Time Stamps

1. In the menu bar, touch **Timebase**, then touch **Acquisition Status...** in the drop-down menu.
2. Touch the **Time** tab.
3. Touch one of the channel buttons under **Select Waveform**.
4. Touch inside the **Select Segment** field and enter a segment number, using the pop-up keypad.

RIS Sampling Mode -- For Higher Sample Rates

RIS (Random Interleaved Sampling) is an acquisition technique that allows effective sampling rates higher than the maximum single-shot sampling rate. It is used on repetitive waveforms with a stable trigger. The maximum effective sampling rate of 50 GS/s can be achieved with RIS by making 100 single-shot acquisitions at 500 MS/s. The bins thus acquired are positioned approximately 20 ps apart. The process of acquiring these bins and satisfying the time constraint is a random one. The relative time between ADC sampling instants and the event trigger provides the necessary variation, measured by the timebase to 5 ps resolution.

The instrument requires multiple triggers to complete an acquisition. The number depends on the sample rate: the higher the sample rate, the more triggers are required. It then interleaves these segments (see figure) to provide a waveform covering a time interval that is a multiple of the maximum single-shot sampling rate. However, the real-time interval over which the instrument collects the waveform data is much longer, and depends on the trigger rate and the amount of interleaving required. The oscilloscope is capable of acquiring approximately 40,000 RIS segments per second.

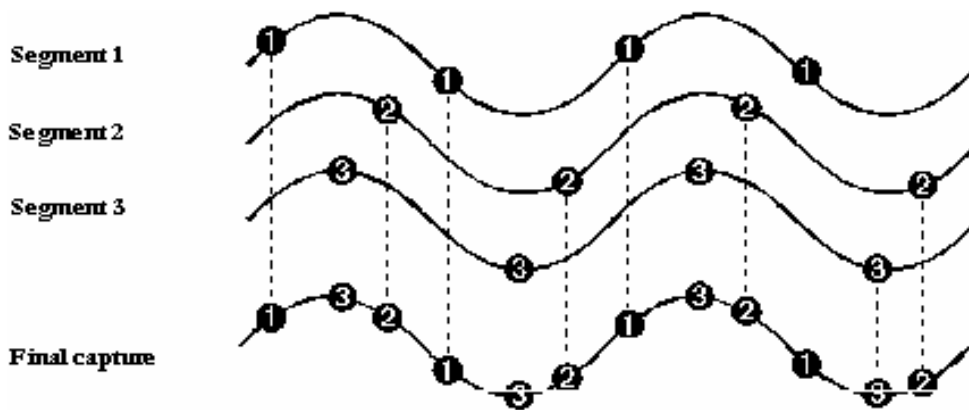

Note: RIS mode is not available when the scope is operating in Fixed Sample Rate mode.

When the SDA 11000 is operating in 11 GHz mode, RIS mode sampling is not available.

Roll Mode

Roll mode applies only to WavePro 7000A and WaveRunner 6000A series scopes. It is invoked automatically when the time per division is 500 ms/div or greater. However, you can cancel Roll Mode and return to Real Time mode at any time.

Roll mode displays, in real time, incoming points in single-shot acquisitions that have a sufficiently low data rate. The oscilloscope rolls the incoming data continuously across the screen until a trigger event is detected and the acquisition is complete. The parameters or math functions connected to each channel are updated every time the roll mode buffer is updated, as if new data is available. This resets statistics on every step of Roll mode that is valid because of new data.

Note: If the processing time is greater than the acquire time, the data in memory gets overwritten. In this case, the instrument issues the warning: **Channel data is not continuous in ROLL mode!!!** and rolling will start over again.

VERTICAL SETTINGS AND CHANNEL CONTROLS

Adjusting Sensitivity and Position

To Adjust Sensitivity

1. Press the appropriate channel push button, for example  to turn on channel 1. Or touch **Vertical** in the menu bar, then **Channel 1** in the drop-down menu.
2. Touch inside the **Trace On** checkbox to display the trace.

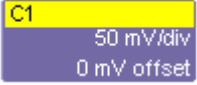

3. Turn the volts per division knob for the selected channel. Or you can touch inside the **Volts/Div** field and type in a value using the pop-up keypad, or use the up/down arrows.

4. The voltage that you set is displayed in the trace descriptor label  and in the **Volts/Div** field.

To Adjust the Waveform's Position

Turn the vertical offset adjust knob directly above the channel button whose waveform you want to move vertically. Or you can touch inside the **Offset** field and type in a value on the pop-up keypad. To set the vertical offset to zero, touch the **Zero Offset** button directly below the **Offset** field.

Coupling

The choices of coupling are as follows:

- DC 50 ohms (all instruments)
- GROUND (all instruments)
- DC 1 Mohms (WavePro & WaveRunner instruments)
- AC 1 Mohms (WavePro & WaveRunner instruments)

Overload Protection

The maximum input voltage is 4 V peak. Whenever the voltage exceeds this limit, the coupling mode automatically switches from DC 50 ohms to GROUND. You will then have to manually reset the coupling to DC 50 ohms, as described next.

To Set Coupling

1. In the menu bar, touch the **Vertical** button, then **Channel X Setup...** in the drop-down menu.

2. Touch inside the **Coupling** field and select a coupling mode from the pop-up menu.

Probe Attenuation

To Set Probe Attenuation

LeCroy's ProBus® system automatically senses probes and sets their attenuation for you. If you want to set the attenuation manually,

1. In the menu bar, touch **Vertical**, then select a channel from the drop-down menu.

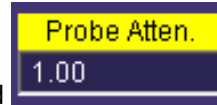

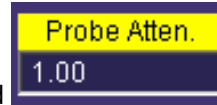
2. Touch inside the **Probe Atten.** data entry field . Touch a divide-by menu selection or touch **Var** (variable). If you choose **Var**, type in a value using the pop-up numeric keypad.

Bandwidth Limit

Reducing the bandwidth also reduces the signal and system noise, and prevents high frequency aliasing.

To Set Bandwidth Limiting

To set bandwidth limiting

1. In the menu bar, touch **Vertical**, then select a channel from the drop-down menu.
2. Touch inside the **Bandwidth** field and select a bandwidth limit value from the pop-up menu. The options are
 - Full (all X-Stream scopes)
 - 4 GHz (WaveMaster 8600A/8500A, DDA-5005A, SDA)
 - 3 GHz (WaveMaster 8600A/8500A/8400A/8420, DDA-5005A, SDA)
 - 1 GHz (WaveMaster Scopes, DDA-5005A, SDA)
 - 200 MHz (all X-Stream scopes)
 - 20 MHz (all X-Stream scopes)

Linear and (SinX)/X Interpolation

Linear interpolation, which inserts a straight line between sample points, is best used to reconstruct straight-edged signals such as square waves. (Sinx)/x interpolation, on the other hand, is suitable for reconstructing curved or irregular waveshapes, especially when the sample rate is 3 to 5 times the system bandwidth.

To Set Up Interpolation

1. Touch the button for the channel you want to set up,  for example.
2. In the dialog area, touch inside the **Interpolation** data entry field under **Pre-Processing**. "Pre-Processing" means before Math processing.
3. Touch inside the **Interpolation** data entry field. A pop-up menu appears offering **Linear** or

Sinx/x interpolation.

4. Touch the button for the type of interpolation you want.

Inverting Waveforms

Touch the **Invert** checkbox to invert the waveform for the selected channel.

QuickZoom

QuickZoom automatically displays a zoom of the channel or trace on a new grid.

To Turn On a Zoom



Touch the **Zoom** button in the channel dialog.

Finding Scale

You can access the **Find Scale** button from the channel setup dialog. This feature automatically calculates peak-to-peak voltage, and chooses an appropriate Volts/Div scale to fully display the waveform.

To Use Find Scale

1. Touch the trace label for the waveform you desire.
2. Touch the **Find Scale** icon.

Variable Gain

Variable Gain lets you change the granularity with which the gain is incremented. For example, when **Variable Gain** is disabled, the gain will increase or decrease in preset increments of 10 or 100 mV each time you touch the **Up/Down** buttons.

However, when **Variable Gain** is enabled, you can increase or decrease the gain in increments as small as 1 mV, depending on the scale of the waveform.

To Enable Variable Gain

1. Touch the descriptor label for the waveform whose gain you want to vary.
2. Touch the **Variable Gain** check box.

Channel Deskew

Unlike the Deskew math function, channel Deskew does no resampling, but instead adjusts the horizontal offset by the amount that you enter. The valid range is dependent on the current timebase ± 9 divisions.

To Set Up Channel Deskew

1. In the menu bar, touch **Vertical**; from the drop-down menu, select a channel to set up.
2. Touch inside the **Deskew** data entry field and enter a value using the pop-up numeric keypad.

TIMEBASE AND ACQUISITION SYSTEM

Timebase Setup and Control

Set up the timebase by using the front panel **Horizontal** controls, just as for analog scopes. For additional timebase setups

1. Touch **Timebase** in the menu bar, then **Horizontal Setup...** in the drop-down menu. The "Horizontal" dialog appears.
2. Touch inside the **Time/Division** data entry field and enter a value using the pop-up numeric keypad, or use the up/down arrows to adjust the value.
3. Touch inside the **Delay** data entry field and type in a value, using the pop-up keypad. Touch the **Set To Zero** button to set the delay to zero.
4. Touch the **SMART Memory** button or tab and adjust the memory as needed.

Autosetup

When channels are turned on, Autosetup operates only on those turned-on channels. If no channels are turned on, all channels are affected. When more than one channel is turned on, the first channel in numerical order with a signal applied to it is automatically set up for edge triggering.



You can perform an autosetup of all these functions together by simply pressing



on the front panel, or by touching **Autosetup** in the Vertical, Timebase, or Trigger drop-down menu.

Dual Channel Acquisition

Combining of Channels

Note: Does not apply to SDA 11000.

Channels can be combined to increase sample rate, memory, or both in order to capture and view a signal in all its detail. When you combine channels, uncombined channels like EXT BNC remain available for triggering, even though they are not displayed.

In 2-channel operation, channels 2 and 3 are active. In Auto operation, you can use channel 1 or 2, and channel 3 or 4. On the paired channels the maximum sampling rate is doubled and the record length is greatly increased:

Ch 1 & Ch 3	20 GS/s
Ch 1 & Ch 4	20 GS/s
Ch 2 & Ch 3	20 GS/s
Ch 2 & Ch 4	20 GS/s

As you can see, sampling can be maximized to 20 GS/s for any combination of two channels,

except a combination of channels 1 *and* 2, or channels 3 *and* 4, which yield 10 GS/s. The basic rule is to choose either channel 1 or 2 for your first input, and either channel 3 or 4 for the second input.

Refer to Acquisition Modes in the specifications for maximum sample rates.

To Combine Channels

1. In the menu bar, touch **Timebase**; the "Horizontal" setup dialog opens.
2. Under **Active Channels**, touch **4, 2** or **Auto**. The maximum sample rate is shown alongside each button.

SDA 11000 DBI Controls

The SDA 11000 scope's 11 GHz bandwidth and 40 GS/s sampling rate are achieved by an innovative LeCroy technology called Digital Bandwidth Interleaving (DBI). This technology allows resources to be borrowed from unused channels to multiply not only sample rate but also bandwidth.



When 11 GHz is selected, the active channels are either C2 or C3 or both, providing 40 GS/s sampling on each channel. For 6 GHz bandwidth, all four channels can be used, providing 20 GS/s sampling on each channel. Channels can be set to allow 11 GHz and 6 GHz bandwidths at the same time, as shown at left.

Bandwidth	Number of Channels	Sample Rate
11 GHz	2	40 GHz
6 GHz	4	20 GHz

SMART Memory

Note: When the SDA 11000 is in 11 GHz mode, only Fixed Sample Rate sampling is available.

LeCroy's SMART Memory feature ensures the highest time resolution for the time window displayed, without aliasing. SMART Memory provides these advantages:

- Acquisition memory is automatically allocated as needed.
- Memory size optimization: Set Maximum Memory optimizes memory to obtain highest sampling rate, reducing the risk of aliasing. You can set a maximum memory up to 48 Mpts.
- Fixed Sample Rate allows setting of a specific sample rate, with the scope calculating the amount of memory needed for a timebase setting.
- The entire acquisition is displayed on the screen.
- High-speed compaction shows all significant features of your waveform.

You can set a maximum memory up to 48 Mpts.

To Set Up SMART Memory

1. Touch **Timebase** in the menu bar, then **SMART Mem Setup...** in the drop-down menu.
2. Touch the **SMART Memory** tab.
3. Under **Timebase Mode**, touch the **Set Maximum Memory** or **Fixed Sample Rate** button. Information about your choice appears below the buttons. The calculated memory length and time per sample point appear below the scroll buttons.
4. Touch inside the **Time/Division** data entry field and set a time per division.

Note: If you are currently acquiring waveforms, you will notice a change in sampling rate as you select different modes.

5. If you selected **Sequence** mode, touch inside the **Num Segments** data entry field and enter a value using the pop-up numeric keypad. If you want to use a timeout period, touch the **Enable Timeout** checkbox; then touch inside the **Timeout** data entry field and enter a value.

TRIGGERING

Trigger Setup Considerations

Trigger Modes

Auto mode causes the scope to sweep even without a trigger. An internal timer triggers the sweep so that the display remains, even when the signal does not cause a trigger.

In Normal mode, the scope sweeps only if the input signal reaches the set trigger point. Otherwise it continues to display the last acquired waveform.

In Single mode, only one sweep occurs each time you press the button.

Stop mode inhibits all sweeps until you select one of the other three modes.

Trigger Types

The triggers available to you are defined as follows:



Edge A simple trigger, Edge trigger is activated by basic waveform features or conditions such as positive or negative slope, and holdoff.



Width One of LeCroy's SMART Triggers®, Width trigger allows you to define a positive- or negative-going pulse width bounded by a voltage level, above or below which a trigger will occur. Or you can specify a pulse width and voltage range, within or outside of which a trigger will occur.



Glitch Another of the SMART Triggers, Glitch trigger is a simpler form of Width trigger. Use Glitch trigger when you want to define a fixed pulse-width time or time range only. Glitch trigger makes no provision for voltage levels or ranges.



Interval While Glitch trigger performs over the width of a pulse, Interval trigger performs over the width of an interval the signal duration (the period) separating two consecutive edges of the same polarity: positive to positive or negative to negative. Use interval trigger to capture intervals that fall short of, or exceed, a given time limit. In addition, you can define a width range to capture any interval that is itself inside or outside the specified range an Exclusion trigger by interval.



Qualify The Qualify trigger is an edge-qualified SMART Trigger that allows you to use one signal's positive or negative transition to qualify a second signal, which is the trigger source. For Qualify trigger, you specify the time or number of events after the transition when you want the trigger to occur.



State The State trigger is a level-qualified SMART Trigger which requires that the qualifying signal remain above or below a specified voltage level for a trigger to occur. For State trigger, you specify the time or number of events after the signal has gone above or below the voltage level when you want the trigger to occur.

 **Dropout** Used primarily in single-shot applications, and usually with a pre-trigger delay, Dropout trigger can detect lost signals. The trigger is generated at the end of the timeout period following the last trigger source transition. You can select a timeout period from 2 ns to 90 s.

 **Logic** Logic trigger enables triggering on a logical combination (pattern) of five inputs: CH1, CH2, CH3, CH4, EXT. You have a choice of four Boolean operators (AND, NAND, OR, NOR), and you can stipulate the high or low voltage logic level for each input independently.

Determining Trigger Level, Slope, Source, and Coupling

Level defines the source voltage at which the trigger circuit will generate an event: a change in the input signal that satisfies the trigger conditions. The selected trigger level is associated with the chosen trigger source.

Trigger level is specified in volts and normally remains unchanged when you change the vertical gain or offset. The amplitude and range of the trigger level are limited as follows:

- ± 5 screen divisions with a channel as the trigger source
- ± 400 mV with EXT as the trigger source
- ± 4 V with EXT/10 as the trigger source
- ± 40 mV with EXT*10 as the trigger source
- None with LINE as the trigger source (zero crossing is used).

Coupling refers to the type of signal coupling at the input of the trigger circuit. Because of the instrument's very high bandwidth, there is only one choice of trigger coupling: DC 50 ohms. However, as a visual check of where ground is, you may switch the channel to ground coupling at any time while testing.

With DC coupling, all of the signal's frequency components are coupled to the trigger circuit for high-frequency bursts.

Slope determines the direction of the trigger voltage transition used for generating a particular trigger event. You can choose a positive or negative slope. Like coupling, the selected slope is associated with the chosen trigger source.

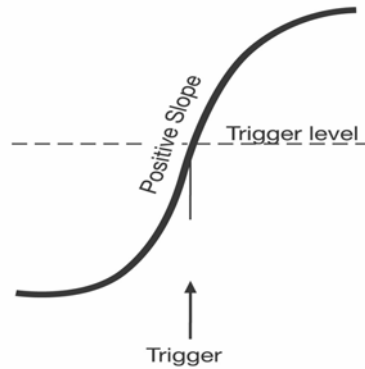

Edge trigger works on the selected edge at the chosen level. The slope (positive or negative) is specified in the Trigger label permanently displayed below-right of the grid.

Trigger Source

The **Trigger On** source may be one of the following:

- The acquisition channel signal (CH 1, CH 2, CH 3 or CH 4) conditioned for the overall voltage gain, coupling, and bandwidth.
- The line voltage that powers the oscilloscope (LINE). This can be used to provide a stable display of signals synchronous with the power line. Coupling and level are not relevant for this selection.
- The signal applied to the EXT BNC connector (EXT). This can be used to trigger the oscilloscope within a range of ± 400 mV on EXT, ± 4 V with EXT/10 as the trigger source, or ± 40 mV with EXT*10 as the trigger source.
- A logic pattern.

Level

Level defines the source voltage at which the trigger circuit will generate an event (a change in the input signal that satisfies the trigger conditions). The selected trigger level is associated with the chosen trigger source. Note that the trigger level is specified in volts and normally remains unchanged when the vertical gain or offset is modified.

The Amplitude and Range of the trigger level are limited as follows:

- ± 5 screen divisions with a channel as the trigger source
- ± 400 mV with EXT as the trigger source
- ± 4 V with EXT/10 as the trigger source
- ± 40 mV with EXT*10 as the trigger source
- none with LINE as the trigger source (zero crossing is used)

Note: Once specified, Trigger Level and Coupling are the only parameters that pass unchanged from trigger mode to trigger mode for each trigger source.

Holdoff by Time or Events

Holdoff is an additional condition of Edge trigger. It can be expressed either as a period of time or an event count. Holdoff disables the trigger circuit for a given period of time or number of events after the last trigger occurred. Events are the number of occasions on which the trigger condition is met. The trigger will again occur when the holdoff has elapsed and the trigger's other conditions are met.

Use holdoff to obtain a stable trigger for repetitive, composite waveforms. For example, if the number or duration of sub-signals is known you can disable them by choosing an appropriate holdoff value. Qualified triggers operate using conditions similar to holdoff.

Hold Off by Time

Sometimes you can achieve a stable display of complex, repetitive waveforms by placing a condition on the time between each successive trigger event. This time would otherwise be limited only by the input signal, the coupling, and the instrument's bandwidth. Select a positive or negative slope, and a minimum time between triggers. The trigger is generated when the condition is met after the selected holdoff time, counted from the last trigger. Any time between 2 ns and 20 s can be selected. The delay is initialized and started on each trigger.

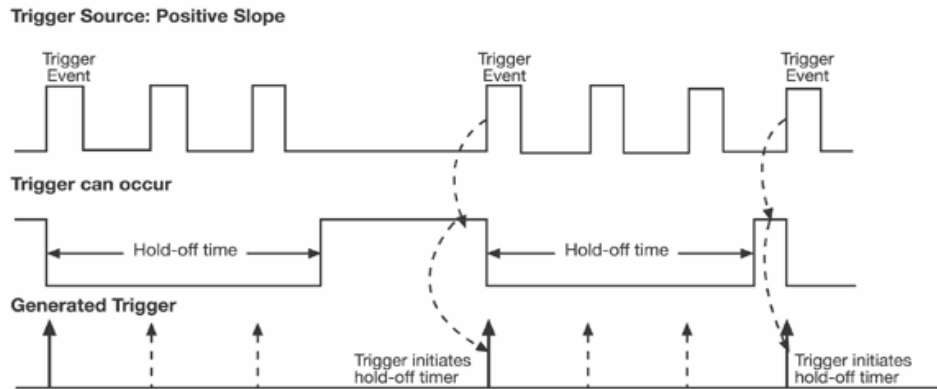

Edge Trigger with Holdoff by Time. The bold edges on the trigger source indicate that a positive slope has been selected. The broken upward-pointing arrows indicate potential triggers, which would occur if other conditions are met. The bold arrows indicate where the triggers actually occur when the holdoff time has been exceeded.

Hold Off by Events

Select a positive or negative slope and a number of events. An event is the number of times the trigger condition is met after the last trigger. A trigger is generated when the condition is met after this number, counted from the last trigger. The count is restarted on each trigger. For example, if the event number is two, the trigger will occur on the third event. From one to 1,000,000,000 events can be selected.

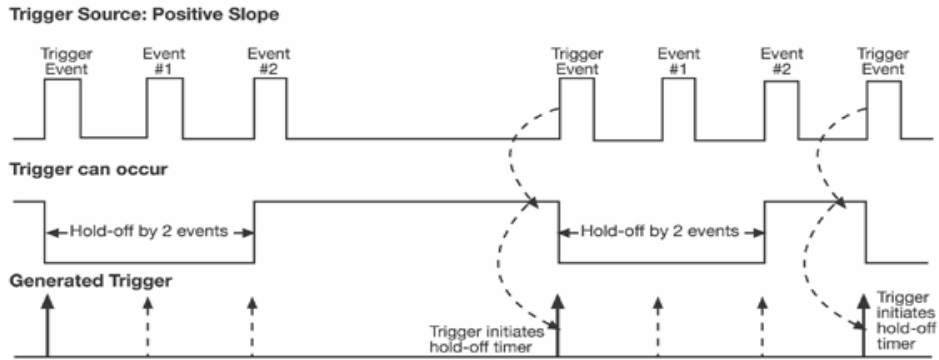

Edge Trigger with Holdoff by Events (in this example, two events). The bold edges on the trigger source indicate that a positive slope has been selected. The broken, upward-pointing arrows indicate potential triggers, while the bold ones show where triggers actually occur after the holdoff expires.

Simple Triggers

Edge Trigger on Simple Signals

The instrument uses many waveform capture techniques that trigger on features and conditions that you define. These triggers fall into two major categories:

- **Edge** activated by basic waveform features or conditions such as a positive or negative slope, and hold-off
- **SMART Trigger®** sophisticated triggers that enable you to use basic or complex conditions for triggering.

Use Edge Triggers for simple signals, and the SMART Triggers for signals with rare features, like glitches.

Control Edge Triggering

Horizontal: Turn the Delay knob in the HORIZONTAL control group to adjust the trigger's horizontal position. Or, touch inside the **Delay** field in the timebase setup dialog and enter a value, using the pop-up keypad.



The trigger location is shown by a marker below the grid



Post-trigger delay is indicated by a left-pointing arrow below-left of the grid

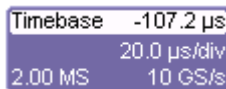

is given in the title line of the **TimeBase** label below-right of the grid.



Vertical: Turn the **Level** knob in the TRIGGER control group to adjust the trigger's vertical threshold.

Turn this knob to adjust the level of the trigger source or the highlighted trace. Level defines the source voltage at which the trigger will generate an event a change in the input signal that satisfies the trigger conditions.

Alternatively, in the "Trigger" dialog, you can touch inside the **Level** field and type in a value, using the pop-up numeric keypad. To quickly set a level of zero volts, touch the **Zero Level** button directly below the **Coupling** field.

An arrow on the left side of the grid shows the threshold position. This arrow is only visible if the trigger source is displayed.

To Set Up an Edge Trigger

Channel Setup

1. In the menu bar, touch **Trigger**, then select **Trigger Setup...** from the drop-down menu.



2. Touch the **Edge** trigger button under the **Trigger** tab.

3. Touch inside the **Trigger On** data entry field and select an input from the pop-up menu:

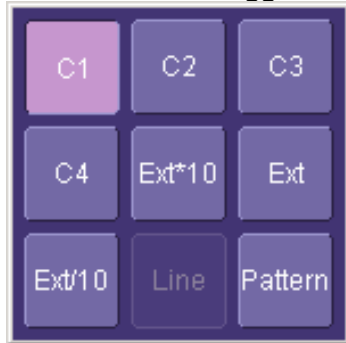

4. Touch inside the **Level** data entry field. In the pop-up numeric keypad,



enter a value in millivolts or use the up/down buttons to increase or decrease the value in increments of 1 mV. Or, touch one of the preset value buttons:





Max.	1.000 V
Default	0 mV
Min.	1.000 V



5. Select the holdoff by touching the **Time** or **Events** buttons. Using the pop-up numeric keypad, enter a value and specify the unit of time:



Or, use the up/down buttons to increase or decrease the time value in increments of 200 ps. Or, touch one of the preset value buttons



The preset **Time** values are as follows:

Max.	20.0 s
Default	50.0 ns
Min.	2 ns

The preset **Events** values are as follows:

Max.	1,000,000,000 events
Default	1 event
Min.	1 event

- Choose **Positive** or **Negative** slope:



SMART Triggers

Width Trigger

How Width Trigger Works

Width trigger allows you to define a positive- or negative-going pulse width bounded by a voltage level, above or below which a trigger will occur. You can specify a pulse width and voltage range, within or outside of which a trigger will occur.

To Set Up Width Trigger

1. In the menu bar, touch **Trigger**, then **Trigger Setup...** in the drop-down menu.



2. Touch the **Width** trigger button
3. Touch inside the **Trigger On** data entry field and select a source on which to trigger:

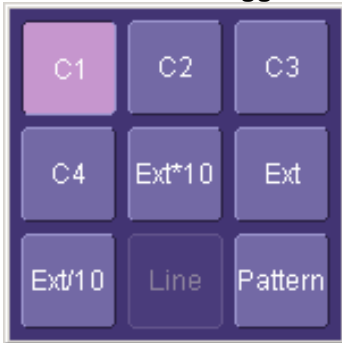

4. Touch inside the **Level** data entry field and enter a value using the pop-up numeric keypad.
5. Select positive or negative slope.
6. Touch the **LessThan** button and enter a pulse-width value in the **Upper Limit** data entry field. Or touch the **GreaterThan** button and enter a pulse-width value in the **Lower Limit**

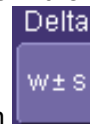

data entry field. Or touch the **InRange** button. Touch the **Delta** button to set up a nominal range, plus or minus a delta value in seconds. Touch inside the **Nominal Width** and **Delta** data entry fields and enter values using the pop-up numeric keypads.



Alternatively, touch the **Limits** button to set up a precise pulse-width range. Touch inside the **Lower Limit** and **Upper Limit** data entry fields and enter values using the pop-up keypads. Or touch the **OutOfRange** button and perform the same range setups as for InRange triggering.

Glitch Trigger

How Glitch Trigger Works

Glitch trigger can be used to catch glitches. You can specify a pulse width or a pulse width range.

Pulse smaller than selected pulse width: Set a maximum pulse width. This glitch trigger is generated on the selected edge (positive or negative) when the pulse width is less than or equal to the set width.

The timing for the width is initialized and restarted on the opposite slope to that selected. You can set widths from 600 ps to 20 s.

NOTE: If the glitch's width is narrower than the signal's width, set the trigger to a narrower width than that of the signal. The signal's width, as determined by the instrument trigger comparator, depends on the DC trigger level. If that level were to be set at the middle of a sine wave, for example, the width could then be considered as the half period. But if the level were higher, the signal's width would be considered to be less than the half period.

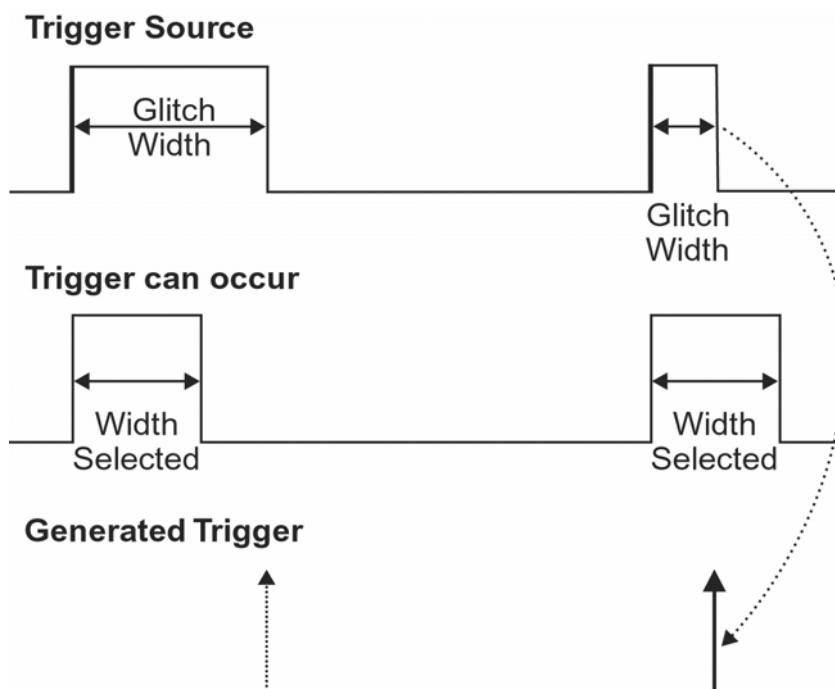

Glitch Trigger: In this example triggering on a pulse width less than or equal to the width selected. The broken upward-pointing arrow indicates a potential trigger, while the bold one shows where the actual trigger occurs.

To Set Up Glitch Trigger

1. In the menu bar, touch **Trigger**, then **Trigger Setup...** in the drop-down menu.



2. Touch the **Glitch** trigger button.
3. Touch inside the **Trigger On** data entry field and select a source on which to trigger:

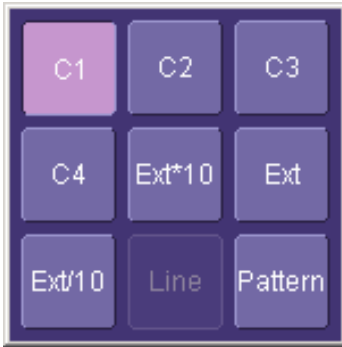

4. Touch inside the **Level** data entry field and enter a value using the pop-up numeric keypad.
5. Select positive or negative slope.
6. Define the width of the glitch you are looking for. You can trigger on any glitch less than a chosen pulse-width (**Upper Limit**); or you can trigger on a chosen range (**InRange**). Touch the **LessThan** button; the **Upper Limit** data entry field alone is displayed. Touch the **InRange** button; the **Upper Limit** and **Lower Limit** fields are displayed.
7. Touch inside the limit field or fields and enter a time value using the pop-up numeric keypad.

Interval Trigger

How Interval Triggers Work

While Glitch trigger performs over the width of a pulse, Interval trigger performs over the width of an interval, with the signal duration (period) separating two consecutive edges of the same polarity: positive to positive or negative to negative. Use Interval trigger to capture intervals that fall short of, or exceed, a given time limit. In addition, you can define a width range to capture any interval that is itself inside or outside the specified range: an exclusion trigger by interval.

Interval Less Than: For this Interval Trigger, generated on a time interval smaller than the one that you set, choose a maximum interval between two like edges of the same slope (positive, for example).

The trigger is generated on the second (positive) edge if it occurs within the set interval. The instrument initializes and restarts the timing for the interval whenever the selected edge occurs. You can set an interval from 2 ns to 20 s.

Trigger Source: Positive Slope

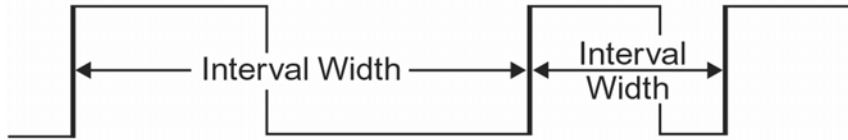

Trigger can occur



Generated Trigger



Interval Trigger that triggers when the interval width is smaller than the selected interval. The broken, upward-pointing arrow indicates a potential trigger, while the bold one shows where the actual trigger occurs on the positive edge within the selected interval.

Interval Greater Than: For this Interval Trigger, generated on an interval larger than the one that you set, select a minimum interval between two edges of the same slope. The instrument generates the trigger on the second edge if it occurs after the set interval. The timing for the interval is initialized and restarted whenever the selected edge occurs. You can set an interval from 2 ns to 20 s.

Trigger Source: Positive Slope

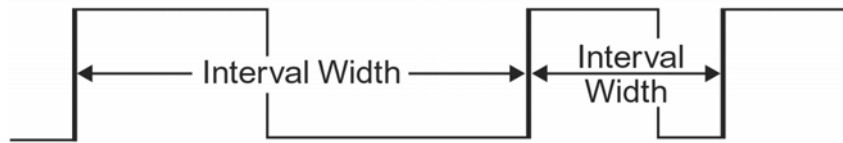

Trigger can occur



Generated Trigger



Interval Trigger that triggers when the interval width is larger than the set interval. The broken upward-pointing arrow indicates a potential trigger, while the bold one shows where the actual trigger occurs on the positive edge after the selected interval.

Interval In Range: This Interval Trigger is generated whenever an interval between two edges of the same slope falls within a selected range. The instrument initializes and restarts the timing for the interval whenever the selected edge occurs. You can set an interval from 2 ns to 20 s.

Trigger Source: Positive Slope

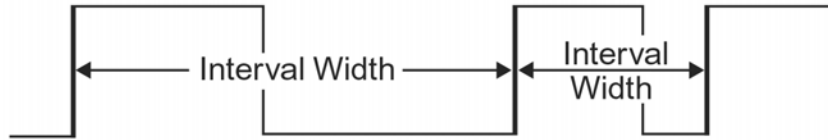

Trigger can occur

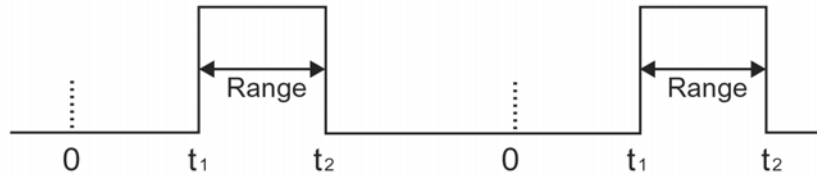

Generated Trigger



*Interval Trigger that triggers when the interval falls within the selected range:
 t_1 = range's lower time limit; t_2 = range's upper limit. The broken upward-pointing arrow indicates a potential trigger, while the bold one indicates where the actual trigger occurs on the positive edge within the selected range.*

To Set Up Interval Trigger

1. In the menu bar, touch **Trigger**, then **Trigger Setup...** in the drop-down menu.



2. Touch the **Interval** trigger button
3. Touch inside the **Trigger On** data entry field and select a source on which to trigger:

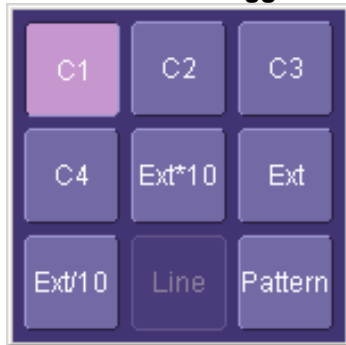

4. Touch inside the **Level** data entry field and enter a value using the pop-up numeric keypad.
5. Select positive or negative slope.
6. Touch the **LessThan** button and enter a pulse-width value in the **Upper Limit** data entry field.

Or touch the **GreaterThan** button and enter a value in the **Lower Limit** data entry field.

Or touch the **InRange** button.



Touch the **Delta** button to set up a nominal range, plus or minus a delta value in seconds. Touch inside the **Nominal Width** and **Delta** data entry fields and enter values using the pop-up numeric keypads.



Touch the **Limits** button to set up a precise range. Touch inside the **Lower Limit** and **Upper Limit** data entry fields and enter values using the pop-up numeric keypads.

Or touch the **OutOfRange** button and perform the same Delta or Limits setup as for InRange triggering.

Qualified Trigger

How Qualified Triggers Work

Use a signal's transition above or below a given level (its validation) as an enabling (qualifying) condition for a second signal that is the trigger source. These are Qualified triggers. For Edge Qualified triggers (the default) the transition is sufficient and no additional requirement is placed on the first signal. For State Qualified triggers the amplitude of the first signal must remain in the desired state until the trigger occurs. A qualified trigger can occur immediately after the validation, or following a predetermined time delay or number of potential trigger events. The time delay or trigger count is restarted with every validation.



Within Time creates a time window within which a trigger can occur.



Wait Time determines a delay from the start of the desired pattern. After the delay (timeout) and while the pattern is present, a trigger can occur. The timing for the delay is restarted when the selected pattern begins.



Events determines a minimum number of events of the trigger source. An event is generated when a trigger source meets its trigger conditions. On the selected event of the trigger source and while the pattern is present, a trigger can occur. The count is initialized and started whenever the selected pattern begins, and continues while the pattern remains. When the selected count is reached, the trigger occurs.

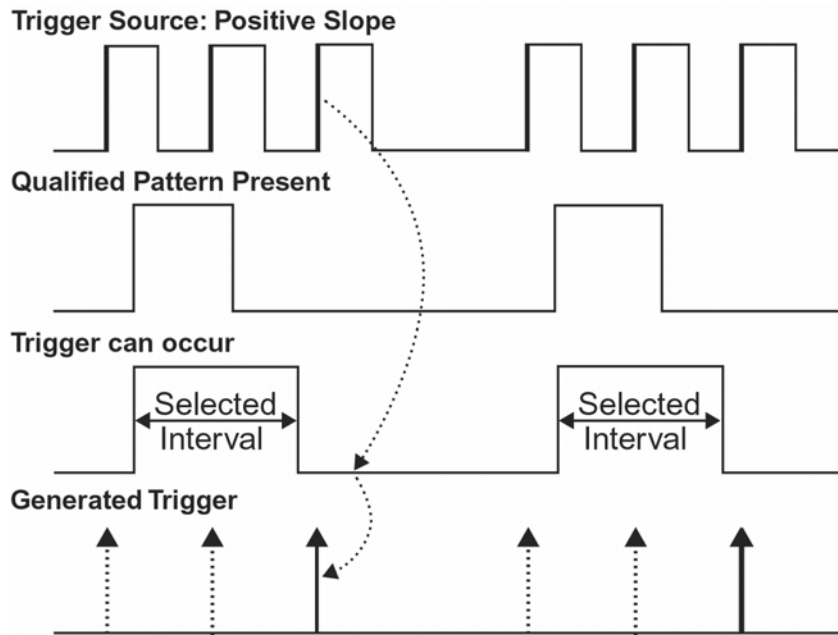

Edge Qualified and Wait: Trigger after timeout. The broken upward-pointing arrows indicate potential triggers, while the bold ones show where the actual triggers occur.

Qualified First Trigger

Qualified First trigger is intended to be used exclusively in Sequence Mode to speed up the trigger rate. With Qualified First trigger, a single valid trigger is sufficient to acquire a full sequence. Other than in Sequence Mode, Qualified First is identical to the Qualified triggers.

In data storage applications, the index pulse can be defined as the qualifier signal and the servo gate signal as the trigger source.

To Set Up an Edge Qualified Trigger

1. In the menu bar, touch **Trigger**, then **Trigger Setup...** in the drop-down menu.



2. Touch the **Qualify** trigger button
3. Touch inside the **Trigger On** data entry field and select a source on which to trigger:

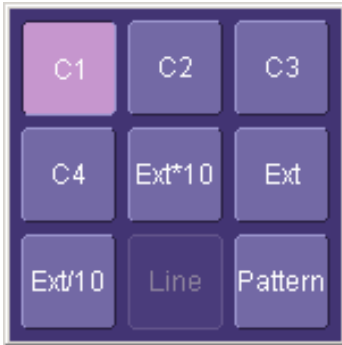

4. Select **Positive** or **Negative** slope.
5. Touch inside the **After** data entry field and select the qualifying signal source from the pop-up menu. If you select an input channel or external source, touch inside the **has gone** data entry field and select a logic level: **Above** or **Below**. Then touch inside the **Level** field and set a voltage level using the pop-up numeric keypad. If you select **Pattern** from the pop-up menu, touch the **Pattern** tab and choose a logic gate:

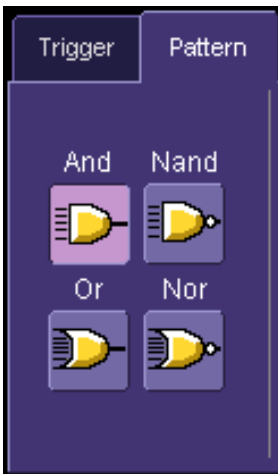

Then touch inside the **State** field for each channel input you want to use in the pattern and select a logic condition: **High** or **Low**. Select **Don't Care** for unused inputs. For the inputs to be used, touch inside each **Level** field and enter a voltage threshold using the pop-up numeric keypad. Then touch the **Trigger** tab again.

6. If you want to set a holdoff in time or events, touch one of the **Qualify by:** buttons:



7. Touch inside the field below the **Qualify by:** buttons and enter a value using the numeric keypad.

- To set up a Qualified First trigger, touch the **Qualify first segment only** checkbox if you are in Sequence mode.

State Trigger

State trigger is another Qualified trigger; however, instead of using the edges of the qualifying inputs, State trigger uses the logic state of the inputs to qualify the trigger. Therefore, the pattern must become true and remain true (for a period of time or number of events that you specify) to qualify the trigger.

See also "How Qualified Triggers Work."

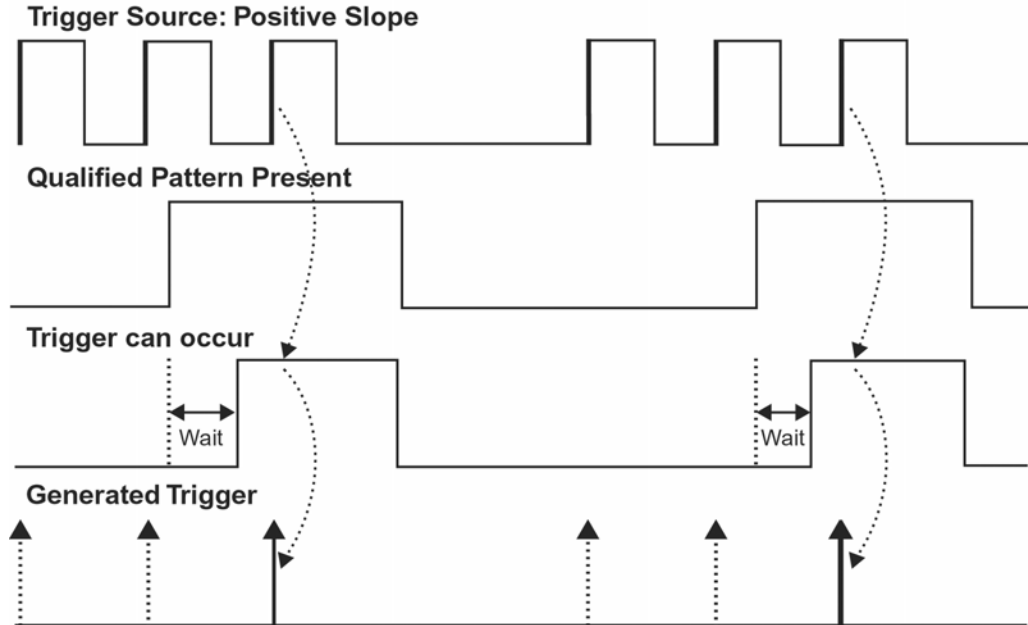

State Qualified and Wait: Trigger after timeout. The broken upward-pointing arrows indicate potential triggers, while the bold arrows show where the actual triggers occur.

To Set Up a State Qualified Trigger

- In the menu bar, touch **Trigger**, then **Trigger Setup...** in the drop-down menu.



- Touch the **State** trigger button
- Touch inside the **Trigger On** data entry field and select a source on which to trigger

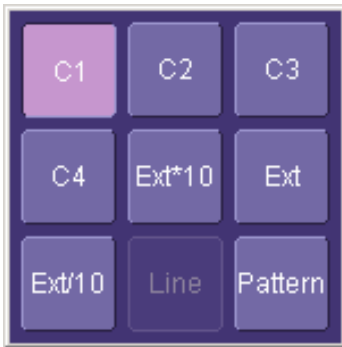

4. Select **Positive** or **Negative** slope.
5. Touch inside the **has gone** data entry field and select the qualifying signal source from the pop-up menu. If you select an input channel or external source, touch inside the **has gone** data entry field and select a logic level: **Above** or **Below**. Then touch inside the **Level** field and set a voltage level using the pop-up numeric keypad. If you want to set a holdoff in time or events, touch one of the holdoff buttons:



6. Touch inside the field below the holdoff buttons and set a value using the numeric keypad.

Dropout Trigger

Used primarily in single-shot applications, and usually with a pre-trigger delay, Dropout trigger can detect lost signals. The trigger is generated at the end of the timeout period following the last trigger source transition. You can set a timeout period from 2 ns to 20 s.

How Dropout Trigger Works

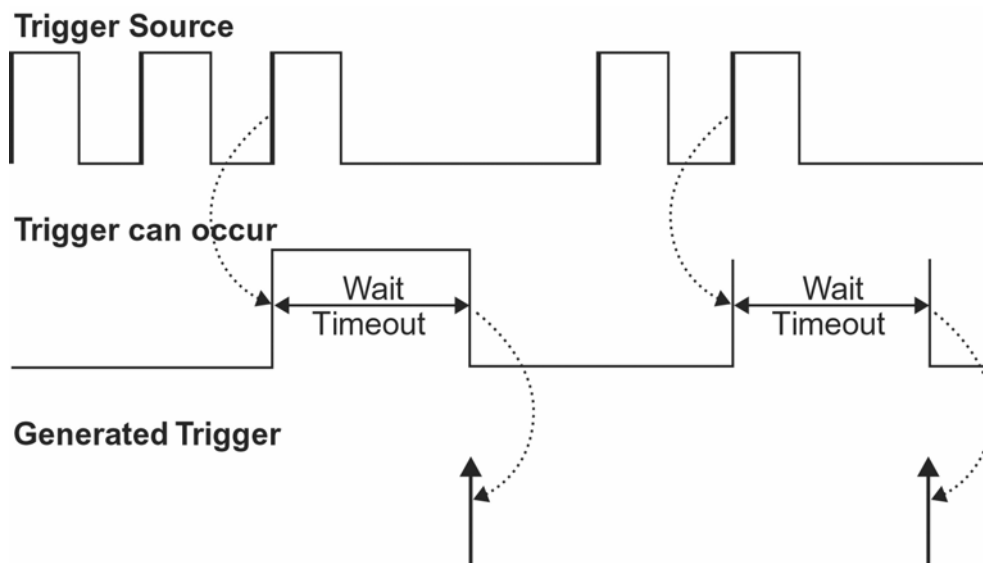

Dropout Trigger: occurs when the timeout has expired. The bold upward-pointing arrows show where the trigger occurs.

To Set Up Dropout Trigger

1. In the menu bar, touch **Trigger**, then **Trigger Setup...** in the drop-down menu.



2. Touch the **Dropout** trigger button.
3. Select **Positive** or **Negative** slope.
4. Touch inside the **Trigger after timeout** data entry field and enter a time window using the pop-up numeric keypad.

Logic Trigger

How Logic Trigger Works

Logic Trigger enables triggering on a logical combination of up to five inputs: CH 1, CH 2, CH 3, CH 4, and EXT. The combination of inputs is referred to as a pattern. There are four logic gates available: AND, NAND, OR, NOR.

A trigger state is either high or low: high when a trigger source is greater than the trigger level (threshold) and low when less than it. For example, an AND pattern could be defined as true when the trigger state for CH 1 is high, CH 2 is low, and EXT is irrelevant (X or don't care). If any one of these conditions is not met, the pattern state is considered false. You can set holdoff limits from 2 ns to 20 s or from 1 to 1,000,000,000 events.

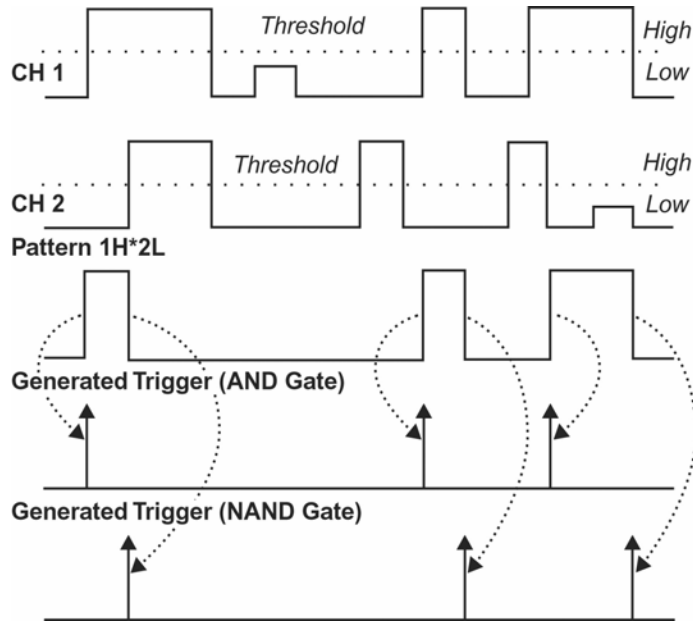

Logic Trigger can be used in digital design for the testing of complex logic inputs or data transmission buses.

To Set Up Logic Trigger

1. In the menu bar, touch **Trigger**, then **Trigger Setup...** in the drop-down menu.



2. Touch the **Logic** trigger button.
3. Touch the **Pattern** tab.
4. For each input you want to include in the logic pattern, touch inside the **State** data entry field and select a logic state: Low or High. Select **Don't Care** for all other inputs.
5. Touch inside the **Level** data entry field for each input included in the pattern and enter a voltage level threshold using the pop-up numeric keypad.
6. Touch the **Trigger** tab.
7. If you want to hold off the trigger (either in time or events) when the pattern becomes true,



touch one of the holdoff buttons

8. Touch inside the holdoff data entry field and enter a value using the pop-up numeric keypad.

Serial Trigger

Serial Trigger is available on SDA "A" model scopes only.

Aux Input Trigger

Some instrument models give you the capability to trigger on an auxiliary input. When you select this option, the auxiliary trigger setup is routed to channel 3, and an information icon appears in the Channel 3 descriptor label:

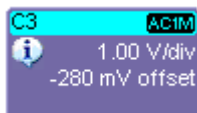

CAUTION

If you select Aux Input trigger on a WavePro 7000A Series scope, but do not input an external signal, the scope will not operate.

To Set Up Aux Input

1. Touch **Trigger** in the menu bar, then **Trigger Setup...** in the drop-down menu.

2. Touch inside the **View AUX IN on Channel 3** checkbox . The **Coupling** field will become disabled.

3. Press the Channel 3 front panel button to turn on Channel 3 and display the setup dialog.
4. Perform vertical setups for your auxiliary input in the Channel 3 dialog.
5. Touch **Vertical** in the menu bar, then **Channels Status...** in the drop-down menu to view a summary of the Aux Input setup:

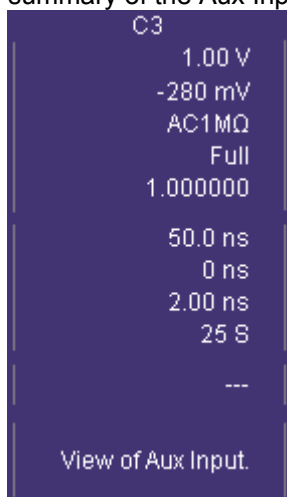

DISPLAY FORMATS

Display Setup

1. In the menu bar, touch **Display**; then touch **Display Setup** in the drop-down menu.
2. Touch one of the **Grid** combination buttons:

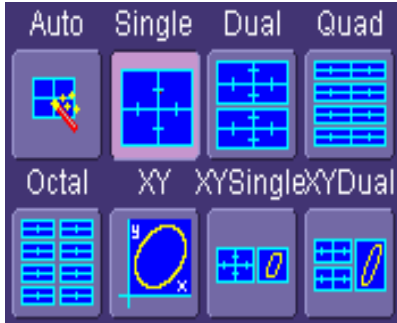

Autogrid automatically adds or deletes grids as you select more or fewer waveforms to display.



3. Touch inside the grid **Intensity** data entry field and enter a value from 0 to 100 using the pop-up keypad.
4. Touch the **Grid on top** checkbox if you want to superimpose the grid over the waveform. Depending on the grid intensity, some of your waveform may be hidden from view when the grid is placed on top. To undo, simply uncheck **Grid on top**.
5. Touch the **Axis labels** checkbox to permanently display the values of the top and bottom grid lines (calculated from volts/div) and the extreme left and right grid lines (calculated from the timebase).



6. Choose a line style for your trace: solid **Line** or **Points**.

Sequence Mode Display

To a set up Sequence Mode display, you must first have selected **Sequence** trigger mode in the Timebase "Horizontal" dialog. You must also have entered a **Num Segments** value.

1. In the menu bar, touch **Display**; then touch **Display Setup** in the drop-down menu.
2. Touch inside the **Display Mode** field and select a display mode from the pop-up menu.

3. Touch inside the **Num seg displayed** field and enter a value, using the pop-up keypad. The maximum number of segments that can be displayed is 80.
4. Touch inside the **Starting at** field and enter a value.

Note: The maximum value that you can enter for **Starting at** depends on the **Num Segments** value you entered in the "Timebase" dialog. It also depends on the **Num seg displayed** value you entered here in the "Display" dialog. For example, if you had entered a value of 500 in **Num Segments**, and a value of 10 in **Num seg displayed**, the maximum value you can enter as a starting segment is 491 so that 10 segments can be seen.

Persistence Setup

The analog Persistence feature helps you display your waveform and reveal its idiosyncrasies or anomalies for a repetitive signal. Use Persistence to accumulate on-screen points from many acquisitions to see your signal change over time. The instrument persistence modes show the most frequent signal path "three-dimensionally" in intensities of the same color, or graded in a spectrum of colors.

You can show persistence for up to eight inputs for any channel, math function, or memory location (M1 to M4).

Saturation Level

The Persistence display is generated by repeated sampling of the amplitudes of events over time, and the accumulation of the sampled data into "3-dimensional" display maps. These maps create an analog-style display. User-definable persistence duration can be used to view how the maps evolve proportionally over time. Statistical integrity is preserved because the duration (decay) is proportional to the persistence population for each amplitude or time combination in the data. In addition, the instrument gives you post-acquisition saturation control for a more detailed display.



When you select  mode from the Persistence dialog (with **All Locked** selected), each channel is assigned a single color. As a persistence data map develops, different intensities of that color are assigned to the range between a minimum and a maximum population. The maximum population automatically gets the highest intensity, the minimum population gets the lowest intensity, and intermediate populations get intensities in between these extremes.

The information in the lower populations (for example, down at the noise level) could be of greater interest to you than the rest. The Analog persistence view highlights the distribution of data so that you can examine it in detail.

You can select a saturation level as a percentage of the maximum population. All populations above the saturation population are then assigned the highest color intensity: that is, they are saturated. At the same time, all populations below the saturation level are assigned the remaining intensities. Data populations are dynamically updated as data from new acquisitions is accumulated.



Color mode persistence, selected by touching , works on the same principle as the Analog persistence feature, but instead uses the entire color spectrum to map signal intensity: violet for minimum population, red for maximum population. A saturation level of 100% spreads the intensity variation across the entire distribution; at lower saturation levels the intensity will saturate (become the brightest color) at the percentage value specified. Lowering this percentage causes the pixels to be saturated at a lower population, and makes visible those rarely hit pixels not seen at higher percentages.

3-Dimensional Persistence

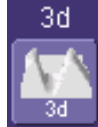

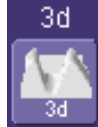
By selecting **3d** , you can create a topographical view of your waveform from a selection of shadings, textures, and hues. The advantage of the topographical view is that areas of highest and lowest intensity are shown as peaks and valleys, in addition to color or brightness. The shape of the peaks (pointed or flat) can reveal further information about the frequency of occurrences in your waveform.

The instrument also gives you the ability to turn the X and Y axes of the waveform through 180° of rotation from -90° to +90°.

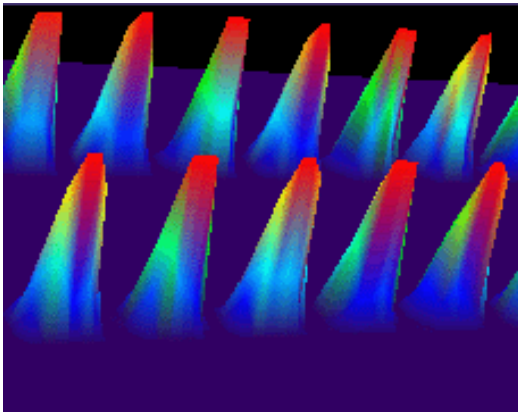

Here is an example of a 3-dimensional view of a square wave using the **solid** view of color-graded persistence. Saturation is set at 50%, with red areas indicating highest intensity. The X-axis has been rotated 60%; the Y-axis has been rotated 15%.



Here is a **monochrome** (analog) view of the same waveform. The lightest areas indicate highest intensity, corresponding to the red areas in the solid view.

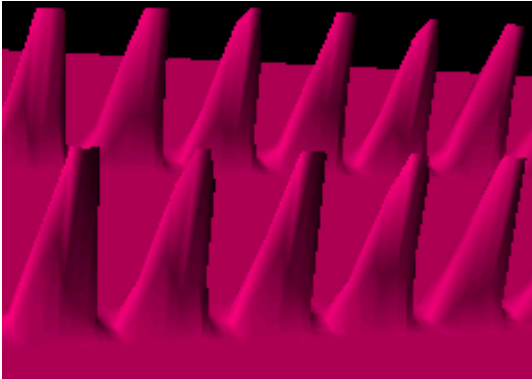

Here is a **shaded** (projected light) view of the same waveform. This view emphasizes the shape of the pulses.

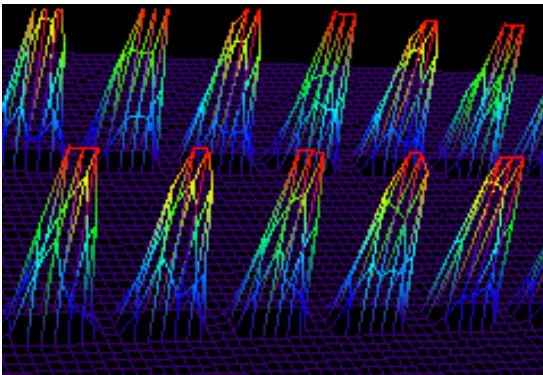

Here is a **wire frame** view of the same waveform in which lines of equal intensity are used to construct the persistence map.

Show Last Trace



For most applications, you may not want to show the last trace because it will be superimposed on top of your persistence display. In those cases turn off **Show Last Trace** by touching the checkbox. However, if you are doing mask testing and want to see where the last trace is falling, turn **Show Last Trace** on.

Persistence Time

You can control the duration of persistence by setting a time limit, in seconds, after which persistence data will be erased: 0.5 s, 1 s, 2 s, 5 s, 10 s, 20 s, or infinity.

Locking of Traces

The instrument gives you the choice of constraining all input channels to the same mode, saturation level, persistence time, and last trace display, or setting these for each input channel individually.

Choose  to constrain input channels. Choose  to set up input channels individually.

To Set Up Persistence

1. In the menu bar touch **Display**, then touch **Persistence Setup...** in the drop-down menu.
2. Touch the **Persistence On** checkbox. If **Per Trace** is selected, touch the **Reset All** button to return all input channel setups to their default settings.
3. Touch the **All Locked** button if you want to set the same mode, saturation level, persistence time, and last trace display for all input channels. Touch the **Per Trace** button to set these for each input channel individually.

- A. If you selected **All Locked**, touch one of the mode buttons

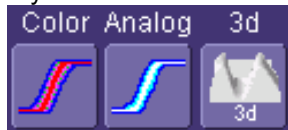



- B. Then touch the **Show last trace** checkbox if you want the last trace displayed.
 - C. Touch inside the **Saturation** data entry field and enter a whole number integer, using the pop-up numeric keypad.
 - D. Touch inside the **Persistence time** data entry field and make a selection from the pop-up menu.
4. If you selected **Per Trace**, for each input channel touch its tab, then make selections of mode, saturation level, persistence time, and last trace display in the same way as for **All Locked**.



5. To create a 3-dimensional view, touch the 3d button . Then
 - A. Touch inside the **Saturation** data entry field and enter a whole number integer, using the pop-up numeric keypad.
 - B. Touch inside the **Persistence time** data entry field and make a selection from the pop-up menu.

- C. Under "3D settings," touch inside the **Quality** field and select an image quality from the pop-up menu: wire frame, solid, or shaded.
 - D. For each axis, touch inside the data entry field and enter a value from -90° to $+90^\circ$.
6. To turn off persistence for an individual channel, touch the left-most persistence mode

button . To turn off persistence for all channels, press the

front panel Analog Persist button . This button toggles Analog Persistence on and off.

Screen Saver

The Windows screen saver is activated in the same way as for any PC.

1. Minimize the instrument display by touching **File** in the menu bar, then **Minimize** in the drop-down menu.
2. Touch **Start** down in the task bar.
3. Touch **Settings** in the pop-up menu.
4. Touch **Control Panel**.
5. Touch **Display**.
6. Touch the **Screen Saver** tab.

Moving Traces from Grid to Grid

You can move traces from grid to grid at the touch of a button.

To Move a Channel or Math Trace

1. Touch the descriptor label for the waveform that you want to move.

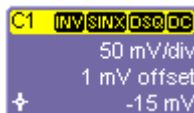

Example Trace Label



2. Touch the **Next Grid** button

Note: If you have more than one waveform displayed on only one grid, a second grid will open automatically when you select **Next Grid**.

Zooming Waveforms



The Zoom button appears as a standard button at the bottom of the channel "Cx Vertical Adjust" setup dialog if you want to create a math function zoom trace of your input waveform. On the other hand, you can zoom a memory or math function non-zoom trace directly without having to create a separate zoom trace. For such traces, a zoom control mini-dialog is provided at the right of each math trace "Fx" setup dialog:

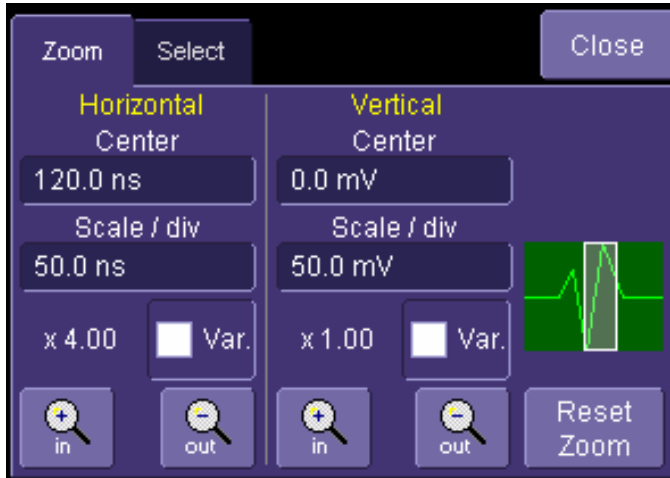

The front panel "QuickZoom" button creates multiple zooms, one for each displayed input channel.

At any time, you can also zoom a portion of a waveform by touching and dragging a rectangle around any part of the input waveform. The zoom trace will size itself to fit the full width of the grid. The degree of magnification, therefore, will depend on the size of the rectangle that you create.

When you zoom a waveform, an approximation of the zoomed area will appear in a thumbnail icon in the "Zoom" dialog:

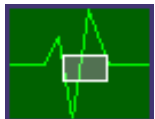

The "Zoom" dialog appears alongside the math setup dialog when Zoom is the math or memory function selected.

To Zoom a Single Channel

1. In the menu bar, touch **Vertical**; then touch a channel number in the drop-down menu. Alternatively, you can just touch the channel trace label for a displayed channel:

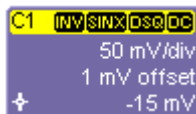

2. Touch **Zoom** at the bottom of the "Cx Vertical Adjust dialog." A zoom math trace (one of F5 to Fx) will be created of the selected channel.
3. To vary the degree of zoom, touch the newly created Fx trace label. The setup dialog for the math function opens, and the zoom control dialog appears at lower-right. It shows the current horizontal and vertical zoom factors.
4. If you want to increase or decrease your horizontal or vertical zoom in small increments, touch the **Var.** checkbox to enable variable zooming. Now with each touch of the zoom



control buttons, the degree of magnification will change by a small increment. To zoom in or out in large standard increments with each touch of the zoom control buttons, leave the **Var.** checkbox unchecked. To set exact horizontal or vertical zoom factors, touch inside the Horizontal **Scale/div** data entry field and enter a time-per-div value, using the pop-up numeric keypad. Then touch inside the Vertical **Scale/div** field and enter a voltage value.

5. To reset the zoom to x1 magnification, touch **Reset Zoom** in the dialog or press the front



panel zoom button

To Zoom by Touch-and-Drag

1. Touch and drag a rectangle around any part of an input channel waveform, math trace, or memory trace. If you have more than one trace displayed, a pop-up "Rectangle Zoom Wizard" will appear.
2. If more than one trace is displayed, touch the "Source" tab and select a trace to act on.
3. Touch the "Action" tab and select **Create a New Zoom Trace**. You will be offered the choice of creating a new zoom trace or modifying the current trace.
4. Touch the **Zoom** tab and select a math function trace to display the zoom.
5. Turn the front panel Wavepilot position knobs to adjust the vertical and horizontal position of the zoom:

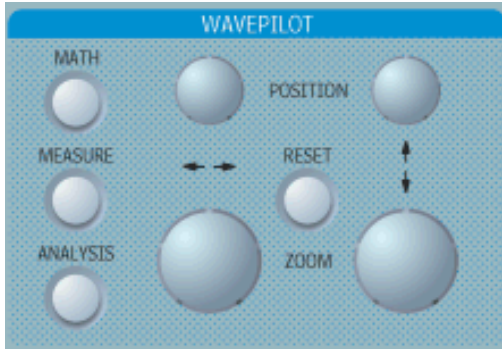

6. Turn the front panel Zoom knobs to control the boundaries of the zoom.

To Zoom Multiple Waveforms Quickly



Press the QuickZoom button  on the front panel. Math function traces **F5** to **F8** will be used to create a zoom of each displayed input channel waveform. Each zoom will be displayed in its own grid.

To Turn Off Zoom

1. Touch the math function trace label for the zoom you want to turn off.
2. Touch the **Trace On** checkbox to delete the check mark and disable the zoom trace.

Multi-Zoom

The Multi-zoom feature creates time-locked zoom traces for only the waveforms that you choose to include. The zooms are of the same X-axis section of each waveform. Thus, as you scroll through a waveform, all included zooms scroll in unison.

To Set Up Multi-zoom

1. In the menu bar, touch **Math**, then **Math Setup...** in the drop-down menu.
2. Verify that the math function selected for each **Fx** position you want to include is **zoom**. If you need to change the math function for any **Fx** position, simply touch the **Fx** button and select **Zoom** from the **Select Math Operator menu**.
3. Touch the **On** checkbox to display each zoom you want to include in the multi-zoom.
4. Touch the Multi-Zoom **Setup** button. The **Multi-Zoom** dialog opens.
5. Touch the Multi-zoom **On** checkbox to enable Multi-zoom. Then touch the **Include** checkbox for each zoom trace you want to include in the time-locked multi-zoom:

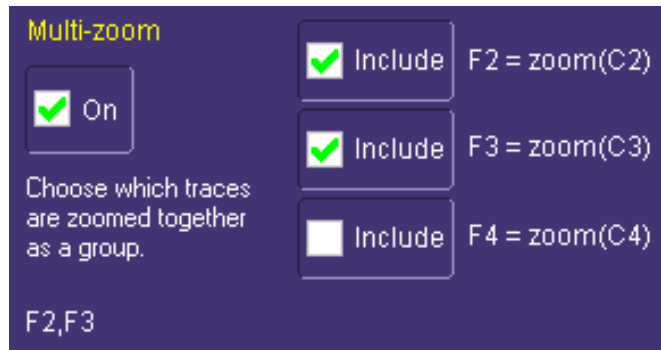

Here the user has chosen to include only F2 and F3 in the Multi-zoom, even though F4 is also a zoom function and is also displayed. Thus, the scrolling feature will not affect zoom F4.

6. Use the **Auto-Scroll** buttons at the right of the Multi-Zoom dialog to control the zoomed section of your waveforms:

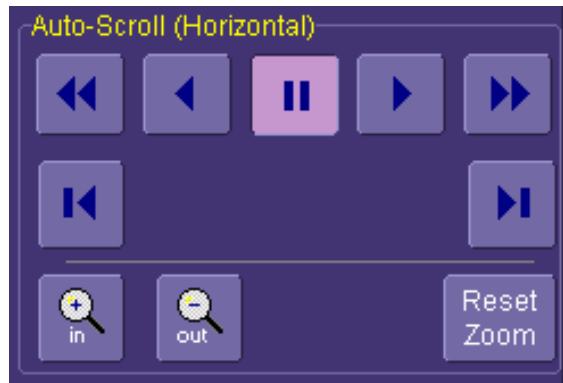

To Turn Off Multi-Zoom

1. In the menu bar, touch **Math**, then **Math Setup...** in the drop-down menu.
2. Touch the Multi-Zoom **On** checkbox to turn off Multi-zoom.

XY Display

Use XY displays to measure the phase shift between otherwise identical signals. You can display either voltage on both axes or frequency on both axes. The traces must have the same X-axis. The shape of the resulting pattern reveals information about phase difference and frequency ratio.

To Set Up XY Displays

1. In the menu bar, touch **Display**; then touch **Display Setup...** in the drop-down menu.
2. Choose an XY display by touching one of the XY display mode buttons



You have the choice of showing the two waveforms on just the XY grid, or you can also show the input waveforms on a single or dual grid.

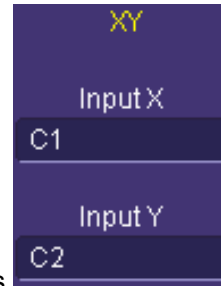

3. Touch inside the **Input X** and **Input Y** data entry fields and select your input sources from the pop-up menus. The inputs can be any combination of channels, math functions, and memory locations.

SAVE AND RECALL

Saving and Recalling Scope Settings

You can save or recall scope settings to or from hard disk, floppy disk, or LAN location.

To Save Scope Settings

1. In the menu bar, touch **File**; then touch **Save Setup...** in the drop-down menu. Or, press the Save/Recall front panel button, then touch the "Save Setup" tab.
2. To **Save To File**, touch inside the **Save Instrument Settings** data entry field and use the pop-up keyboard to enter the path to the destination folder. Or touch **Browse** to navigate to



the destination folder. Then touch

To save to folder **Internal Setups** on the scope's hard drive, touch inside a **SetupX** data



entry field and use the pop-up keyboard to enter a file name. Touch alongside the data entry field. The file is deposited in **D:\Internal Setups**, and the current date is displayed above the field.

To Recall Scope Settings

1. In the menu bar, touch **File**; then touch **Recall Setup...** in the drop-down menu.
2. To **Recall From File**, touch inside the **Recall panels from file** data entry field and use the pop-up keyboard to enter the path to the source folder. Or touch **Browse** to navigate to the



source folder. Then touch



on the scope's hard drive, touch alongside the file you want to recall.

To Recall Default Settings

1. In the menu bar, touch **File**; then touch **Recall Setup...** in the drop-down menu.
2. Touch the button under **Recall Default Setup**



The default settings are as follows:

Vertical	Timebase	Trigger
50 mV/div	50.0 ns/div	DC50 or AC1M (model dependent), C1, 0 mV trigger level
0 V offset	5.0 or 10.0 GS/s (model dependent)	edge trigger positive edge
	0 s delay	Auto trigger mode

Saving Screen Images

You can send images to a hard copy printer or to storage media. Both types of output are done from the same dialog.

1. In the menu bar, touch **Utilities**, then **Utilities Setup...** in the drop-down menu.
2. Touch the **Hardcopy** tab.
3. Touch the **File** button.
4. Touch inside the **File Format** field and select a file type.
5. Under **Colors**, touch the **Use Print Colors** checkbox if you want your waveforms to print in color with a white background. A white background saves printer toner.
6. Touch inside the **Directory** field and type in the path to the directory where you want the image stored, using the pop-up keyboard. Or you can touch the browse button and navigate there.
7. Touch inside the **File Name** field and type in a name for your image, using the pop-up keyboard.
8. Under **Include On Print**, touch the **Grid Area Only** checkbox if you do not want to include the dialog area in the image.
9. Touch the **Print Now** button.

Saving and Recalling Waveforms

Saving Waveforms

1. In the menu bar, touch **File**; then touch **Save Waveform...** in the drop-down menu.



2. In the "Save Waveform" dialog, touch the **Save To** button or button.
3. Touch inside the **Source** field and select a source from the pop-up menu. The source can be any trace; for example, a channel (C1-C4), math function (F1-F4), or a waveform stored

in memory (M1-M4).

4. Touch inside the **Trace Title** data entry field if you want to change the default name of your waveforms. Use the pop-up keyboard to type in the new name.

Note: You can change the name but not the sequence number.

CAUTION

If you use a name that ends in a number instead of a letter, the instrument may truncate the number. This is because, by design, the first waveform is automatically numbered 0, the second 1, etc. For example, if you want to use waveform name "XYZ32" but it is not preceded by waveforms XYZ0 through XYZ31, the waveform will be renumbered with the next available number in the sequence.

If you need to use a number in your waveform's name, it is recommended that you append an alpha character at the end of the number : "XYZ32a" for example.

5. If you are saving to file, touch the **Data Format** field and select a format type from the pop-up menu:

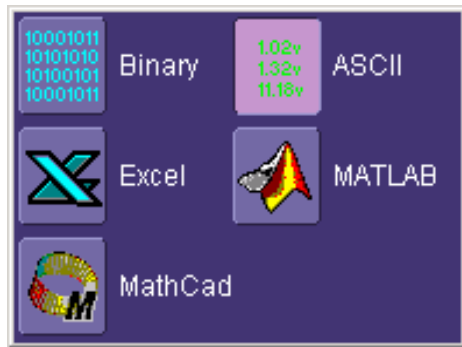

If you select **ASCII** or **Excel**, also touch the **SubFormat** field and select either **Time Data** or **Time & Ampl.** Then touch the **Delimiter** field and select a delimiter character from the pop-up menu: comma, space, semicolon, or tab.

6. Touch the **Browse** button for the **Save file in directory** field and browse to the location where you want the file saved. The file name is assigned automatically and is shown below the field.



7. Touch .

Auto Save

You can also enable Auto Save from this dialog by touching one of the **Auto Save** buttons



: **Wrap** (old files overwritten) or **Fill** (no files overwritten).



CAUTION

If you select **Fill**, you can quickly use up all disk space on your hard disk.

Recalling Waveforms

1. In the menu bar, touch **File**; then touch **Recall Waveform...** in the drop-down menu.

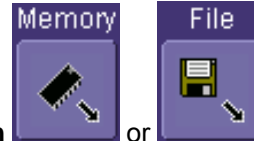

2. In the "Recall Waveform" dialog, touch the **Recall From** button.
 - A. If you selected **Memory**, touch inside the **Source** field and select a memory location: **M1** to **M4**.
 - B. If you selected **File**, touch inside the **Destination** field and select a memory location in which to store the file.

Touch inside the **Show only files** field and select an area to limit the search to: channels, math functions, or memory.

Touch inside the **Recall files from directory** data entry field and enter the path, using the pop-up keyboard. Or touch the **Browse** button to navigate to the file.

Touch inside the **Next file will be recalled from** data entry field and enter the path, using the pop-up keyboard. Or touch the **Browse** button to navigate to the file.



3. Touch

Disk Utilities

Use the Disk Utilities dialog to delete files or create folders.

To Delete a Single File

1. Touch **File** in the menu bar, then **Disk Utilities...** in the drop-down menu.



2. Touch the **Delete** button in the "Disk Utilities" dialog.
3. Touch inside the **Current folder** data entry field and use the pop-up keyboard to enter the path to the folder that contains the file you want to delete. Or touch the **Browse** button and

navigate to the folder.

4. Touch inside the **File to be deleted** data entry field and use the pop-up keyboard to enter the name of the file. Or touch the **Browse** button and navigate to the file.
5. Once you have located the file, touch the **Delete File** button.

To Delete All Files in a Folder

1. Touch **File** in the menu bar, then **Disk Utilities...** in the drop-down menu.



2. Touch the **Delete** button in the "Disk Utilities" dialog.
3. Touch inside the **Current folder** data entry field and use the pop-up keyboard to enter the path to the folder that contains the file you want to delete. Or touch the **Browse** button and navigate to the folder.
4. Once you have located the folder, touch the **Empty Folder** button.

To Create a Folder

1. Touch **File** in the menu bar, then **Disk Utilities...** in the drop-down menu.



2. Touch the **Create** button in the "Disk Utilities" dialog.
3. Touch inside the **Current folder** data entry field and use the pop-up keyboard to enter the path to the directory you want to create the folder in, and the name of the folder.
4. Touch the **Create Folder** button.

PRINTING AND FILE MANAGEMENT

Print, Plot, or Copy

The instrument gives you the ability to output files to a printer or plotter, to print to file, or to e-mail your files. Any WindowsXP supported printer is supported by your instrument.

Printing

To Set Up the Printer

1. In the menu bar, touch **File**, then **Print Setup...** in the drop-down menu. The Utilities **Hardcopy** dialog opens.
2. In the dialog area, touch the **Printer** icon .
3. Under **Colors**, touch the **Use Print Colors** checkbox if you want the traces printed on a white background. A white background saves printer toner. (You can change the printer colors in the Preference dialog;)
4. Touch inside the **Select Printer** field. From the touch pad pop-up choose the printer you want to print to. Touch the **Properties** button to see your printer setup.
5. Touch the icon for the layout **Orientation** you want: portrait or landscape.
6. Touch the **Grid Area Only** checkbox if you do not need to print the dialog area and you only want to show the waveforms and grids.

To Print

You can print in one of three ways:

- Press the printer button on the front panel:
- In the menu bar, touch **File**, then **Print** in the drop-down menu.
- Touch the **Print Now** button in the "Hardcopy" dialog

Adding Printers and Drivers

Note: If you want to add a printer driver, the driver must first be loaded on the scope.

1. In the menu bar, touch **File**, then **Print Setup...** in the drop-down menu. The Utilities **Hardcopy** dialog opens.
2. In the dialog area, touch the **Printer** icon .
3. Touch the **Add Printer** button. An MS Windows® window with which to add a printer will open.
4. Touch the Properties button to change printer properties such as number of copies.

Changing the Default Printer

1. If you want to change the default printer, minimize the instrument application by touching **File** in the menu bar, then **Minimize** in the drop-down menu.
2. Touch the **Start** button in the task bar at the bottom of the screen.
3. Select **Settings**, then **Printers**.
4. Touch the printer you want to set as the default printer, then touch **File, Set as Default Printer**.

Managing Files

Use the instrument's utilities to create waveform files on floppy disk, internal hard drive or network drives. You can copy files from your hard drive to floppy disk. You also can give your files custom names and create directories for them.

Hard Disk Partitions

The instrument's hard disk is partitioned into drive **C:** and drive **D:**. Drive **C:** contains the Windows operating system and the instrument application software. Drive **D:** is intended for data files.

100BASE-T ETHERNET CONNECTION

Connecting to a Network

Use the Ethernet connector (item 8 in the rear panel diagram) to connect the instrument to a network:

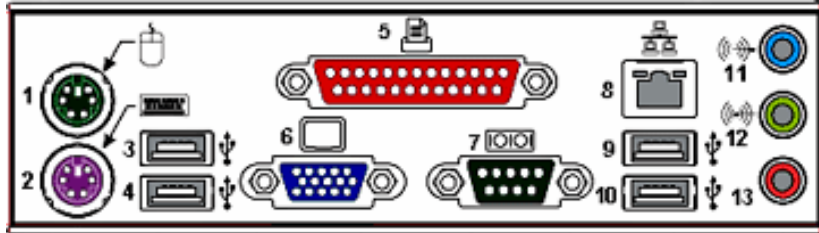

Communicating over the Network

The instrument uses Dynamic Host Configuration Protocol (DHCP) as its addressing protocol. Therefore, there is no factory set IP address.

Windows Setups

If the instrument is to reside within a domain on your LAN, your IS administrator will have to connect the scope.

Guidelines for Working in Windows

Although the instrument has an open architecture, avoid modifying the Windows operating system, since this may cause problems for the instrument's user interface. Please follow these recommendations:

- Do not load any version of Windows not provided by LeCroy. If you load any Windows XPe service packs from Microsoft, please be advised that LeCroy cannot guarantee trouble-free operation afterwards.
- If the instrument powers up in Windows Safe Mode, the touch screen will not function. You may need a mouse or keyboard to restore normal operation.
- Avoid modifying Control Panel settings.
- Do not change the color resolution (24 bit) or screen size (800 x 600 pixel) settings.
- After you load third-party software applications, if your scope does not work properly try reloading the instrument software from the CD shipped with the scope. If your instrument is not equipped with a CD drive, you will need a USB CD-ROM to do this (not supplied by LeCroy).
- Do not modify or remove any system fonts; doing so may affect the readability of the dialogs.
- Do not change any display properties like Background, Appearance, Effects, or Settings. Functionality of the scope or screen saver may be affected.

- Do not make any changes to the Windows folder.
- Do not make any changes to the BIOS settings.
- Do not make any changes to the Windows power management system.

System Restore

Although the scope creates regularly scheduled restore points automatically, before you install any hardware or software on your instrument, LeCroy strongly recommends that you manually create a restore point. The restore point resides on the scopes hard drive, so no external storage medium (floppy disk, USB memory stick, etc.) is required.

To Create a Restore Point

1. From the **File** menu, minimize or Window the scope display to reveal the task bar.
2. In the task bar, select **Start, Programs, Accessories, System Tools, System Restore**.
3. Touch the **Create a restore point** radio button, then touch **Next**.
4. In the **Restore point description** box, indicate what software or hardware is going to be added after the restore point is created, then touch **Next**.
5. The restore point will be created and a confirmation message will be displayed.

TRACK VIEWS

Creating and Viewing a Trend

1. In the menu bar, touch **Measure**, then **Measure Setup** in the drop-down menu.
2. Touch one of parameter tabs **P1** through **Px**.
3. Touch inside the **Source1** data entry field and select an input waveform from the pop-up menu.
4. Touch inside the **Measure** data entry field and select a parameter from the pop-up menu.



5. Touch the **Trend** button at the bottom of the dialog; then, from the **Math selection for Trend** menu, select a math function location (F1 to Fx The number of math traces available depends on the software options loaded on your scope. See specifications.) to store the Trend display. The Trend will be displayed along with the trace label for the math function you selected.
6. Touch the newly displayed Trend math function trace label if you want to change any settings in the Trend dialog:

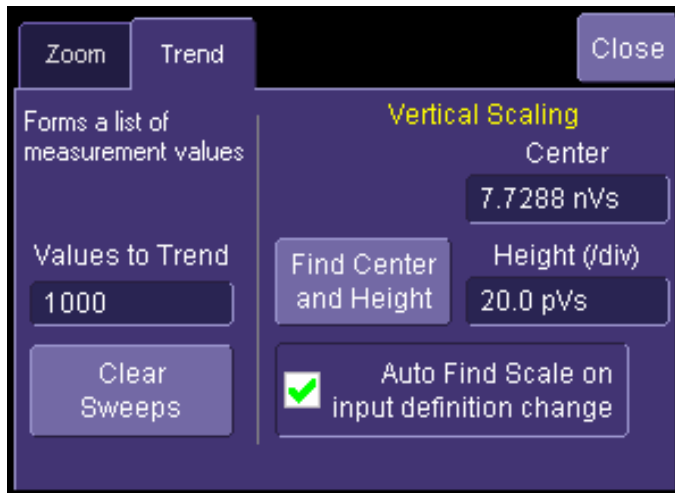

Creating a Track View

This feature is available in the XMAP option.

1. In the menu bar, touch **Measure**, then **Measure Setup** in the drop-down menu.
2. Touch one of parameter tabs **P1** through **Px**.
3. Touch inside the **Source1** data entry field and select an input waveform from the pop-up menu.

4. Touch inside the **Measure** data entry field and select a parameter from the pop-up menu.



5. Touch the **Track** button at the bottom of the dialog; then, from the **Math selection for Track** menu, select a math function location (F1 to Fx) to store the Track display. The Track will be displayed along with the trace label for the math function you selected:



6. Touch the newly displayed Track math function trace label if you want to change any settings in the Track dialog:

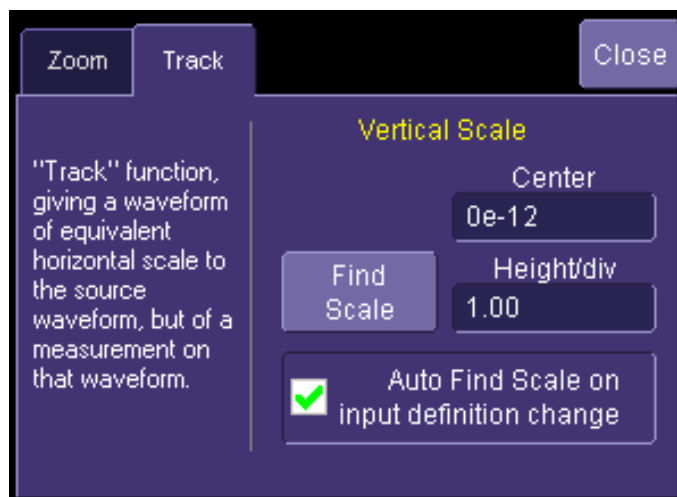

HISTOGRAMS

Creating and Viewing a Histogram

Note: The number of sweeps comprising the histogram will be displayed in the bottom line of the trace descriptor label:

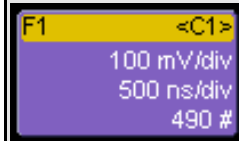

To Set Up a Single Parameter Histogram

From Measure Dialog

1. In the menu bar, touch **Measure**, then **Measure Setup**.
2. Touch the **My Measure** button.
3. Touch one of tabs **P1** through **Px**.
4. Touch inside the **Source1** field and select an input waveform from the pop-up menu.
5. Touch inside the **Measure** field and select a parameter from the pop-up menu.
6. Touch the **Histogram** button at the bottom of the dialog.
7. Touch a math trace in which to place the resulting histogram, then close the pop-up menu.
8. Touch the math trace label for the math trace you just created.
9. In the dialog to the right, touch the Histogram tab.
10. Under "Buffer," touch inside the #Values data entry field and enter a value.
11. Under "Scaling," touch inside the #Bins data entry field and enter a value from 20 to 2000.
12. Touch the Find Center and Width button to center the histogram. Or touch inside the Center, then the Width, data entry fields and enter a value using the pop-up numeric keypad.

From Math Dialog

1. In the menu bar, touch **Math**, then **Math Setup**.
2. Touch one of function tabs **F1** through **Fx** The number of math traces available depends on the software options loaded on your scope. See specifications..



3. Touch the **Graph** button .
4. Touch inside the **Source1** field and select a source from the pop-up menu.
5. Touch inside the **Measurement** field and select a parameter from the pop-up menu.
6. Touch inside the **Graph with** field and select **Histogram** from the pop-up menu.
7. In the dialog to the right, touch the **Histogram** tab.

- Under "Buffer," touch inside the **#Values** data entry field and enter a value from 20 to 1000.
- Under "Scaling," touch inside the **#Bins** data entry field and enter a value from 20 to 2000.
- Touch the **Find Center and Width** button to center the histogram. Or touch inside the **Center**, then the **Width**, data entry fields and enter a value using the pop-up numeric keypad.
- Touch inside the Vertical Scale field and select **Linear** or **Linear Constant Max** from the pop-up menu:

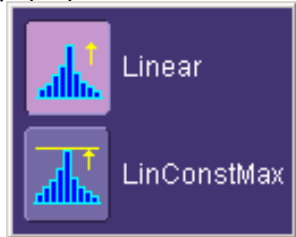

To View Thumbnail Histograms

Histicons are miniature histograms of parameter measurements that appear below the grid. These thumbnail histograms let you see at a glance the statistical distribution of each parameter.

- In the menu bar, touch **Measure**, then one of the Measure Mode buttons: **Std Vertical**, **Std Horizontal**, or **My Measure**.
- Touch the **Histicons** checkbox to display thumbnail histograms below the selected parameters.

Note: For measurements set up in My Measure, you can quickly display an enlarged histogram of a thumbnail histogram by touching the Histicon you want to enlarge. The enlarged histogram will appear superimposed on the trace it describes. This does not apply to "Std Vertical" or "Std Horizontal" measurements.

Persistence Histogram

You can create a histogram of a persistence display also by cutting a horizontal or vertical slice through the waveform. You also decide the width of the slice and its horizontal or vertical placement on the waveform.

This math operation is different than the "Histogram" math operation and is not affected by **Center** and **Width** settings made there.

To Set Up Persistence Histograms

- In the menu bar, touch **Math**, then **Math Setup**.
- Touch one of function tabs **F1** through **Fx**. The number of math traces available depends on the software options loaded on your scope. See specifications..
- Touch inside the **Source1** field and select a source from the pop-up menu.
- Touch inside the **Operator1** field and select **Phistogram**  from the **Select Math Operator** menu.

5. Touch the "Histogram" tab, then touch inside the Slice Direction field and select **Horizontal** or **Vertical** slice from the pop-up menu.
6. Touch inside the **Slice Center** field and enter a value, using the pop-up keypad.
7. Touch inside the **Slice Width** field and enter a value, using the pop-up keypad.

Note: You can use the front panel Adjust knobs to move the **Slice Center** line and the **Slice Width** boundary lines.

Persistence Trace Range

This math operation has a field where you can enter the percent of the persistence trace population to use in creating a new waveform.

Persistence Sigma

This math operation has a field where you can enter a scale, measured in standard deviations, by which to create a new waveform.

Histogram Parameters

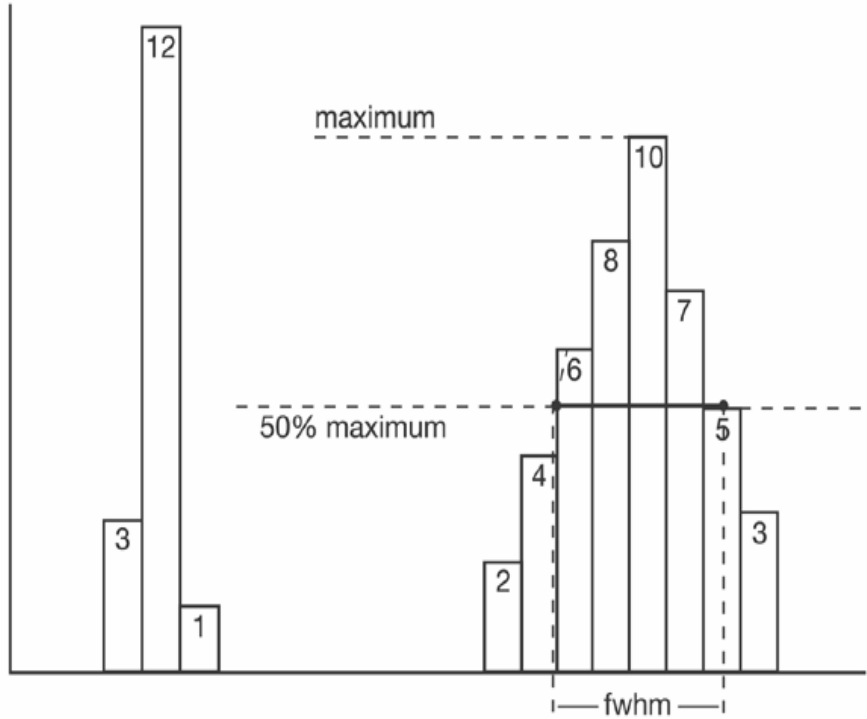
fwhm	Full Width at Half Maximum
Definition:	Determines the width of the largest area peak, measured between bins on either side of the highest bin in the peak that have a population of half the highest's population. If several peaks have an area equal to the maximum population, the leftmost peak is used in the computation.
Description:	First, the highest population peak is identified and the height of its highest bin (population) determined (for a discussion on how peaks are determined see the pks parameter Description:). Next, the populations of bins to the right and left are found, until a bin on each side is found to have a population of less than 50% of that of the highest bin's. A line is calculated on each side, from the center point of the first bin below the 50% population to that of the adjacent bin, towards the highest bin. The intersection points of these lines with the 50% height value is then determined. The length of a line connecting the intersection points is the value for fwhm.
Example:	 <p>The example histogram shows a distribution of bars with the following populations from left to right: 3, 12, 1, 2, 4, 6, 8, 10, 7, 5, 3. The highest bin has a population of 12. A horizontal dashed line at 50% maximum (6) intersects lines drawn from the center of the bin with population 6 to the adjacent bins with populations 4 and 8. The distance between these intersection points is labeled fwhm.</p>

fwxx	Full Width at xx% Maximum
Definition:	Determines the width of the largest area peak, measured between bins on either side of the highest bin in the peak that have a population of xx% of the highest's population. If several peaks have an area equal to the maximum population, the leftmost peak is used in the computation.
Description:	First, the highest population peak is identified and the height of its highest bin (population) determined (see the pks description). Next, the bin populations to the right and left are found until a bin on each side is found to have a population of less than xx% of that of the highest bin. A line is calculated on each side, from the center point of the first bin below the 50% population to that of the adjacent bin, towards the highest bin. The intersection points of these lines with the xx% height value is then determined. The length of a line connecting the intersection points is the value for fwxx.
Example:	fwxx with threshold set to 35%:

hist ampl	Histogram Amplitude
Definition:	The difference in value of the two most populated peaks in a histogram. This parameter is useful for waveforms with two primary parameter values, such as TTL voltages, where hampl would indicate the difference between the binary `1` and `0` voltage values.
Description:	The values at the center (line dividing the population of peak in half) of the two highest peaks are determined (see pks parameter description:). The value of the leftmost of the two peaks is the histogram base (see hbase). While that of the rightmost is the histogram top (see htop). The parameter is then calculated as: hampl = htop hbase
Example:	<p>The diagram shows a histogram with two primary peaks. The first peak, labeled 'peak #1', is centered at a value of 150. The second peak, labeled 'peak #2', is centered at a value of 152. A horizontal line labeled 'hampl' indicates the distance between the center of peak #1 (labeled 'base') and the center of peak #2 (labeled 'top').</p>
	In this histogram, hampl is 152 mV 150 mV = 2 mV.

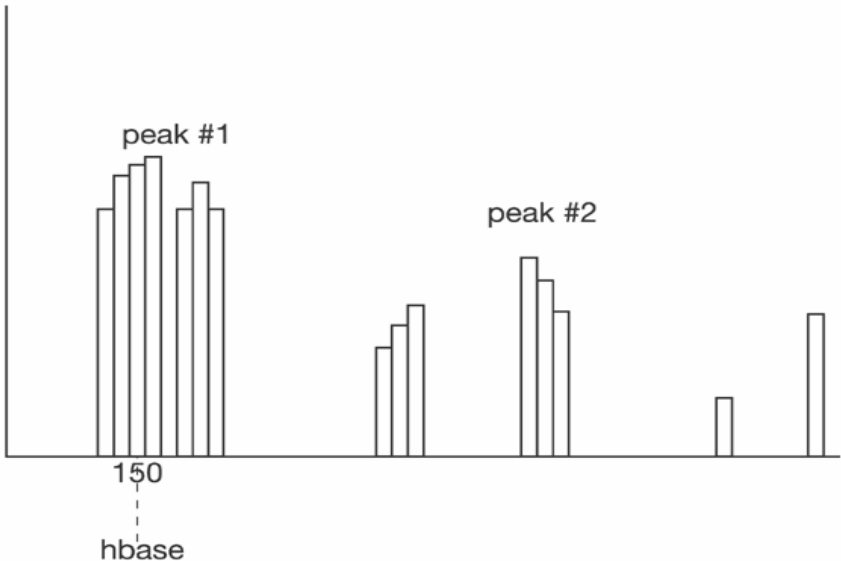
hbase	Histogram Base
Definition:	The value of the leftmost of the two most populated peaks in a histogram. This parameter is primarily useful for waveforms with two primary parameter values such as TTL voltages where hbase would indicate the binary '0' voltage value.
Description:	The two highest histogram peaks are determined. If several peaks are of equal height the leftmost peak among these is used (see pks). Then the leftmost of the two identified peaks is selected. This peak's center value (the line that divides the population of the peak in half) is the hbase.
Example:	 <p>The example shows a histogram with two main clusters of bars. The first cluster, labeled 'peak #1', is on the left and consists of several bars of varying heights. A vertical dashed line is drawn at the center of this cluster, labeled 'hbase' at the bottom, with the value '150' marked on the x-axis. The second cluster, labeled 'peak #2', is on the right and also consists of several bars. There are also a few isolated bars to the right of peak #2.</p>

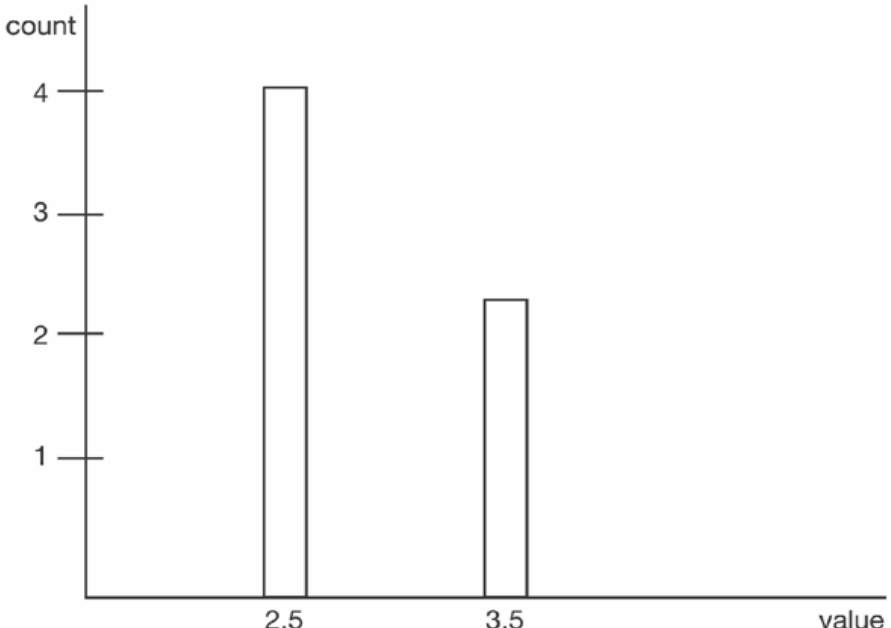
hist rms	Histogram Root Mean Square
Definition:	The rms value of the values in a histogram.
Description:	The center value of each populated bin is squared and multiplied by the population (height) of the bin. All results are summed and the total is divided by the population of all the bins. The square root of the result is returned as hrms.
Example:	Using the histogram shown here, the value for hrms is:
	$hrms = \sqrt{(3.5^2 * 2 + 2.5^2 * 4) / 6} = 2.87$
	 <p>The histogram displays two data points. The first point is at a value of 2.5 with a count of 4. The second point is at a value of 3.5 with a count of 2. The vertical axis represents the count, and the horizontal axis represents the value.</p>

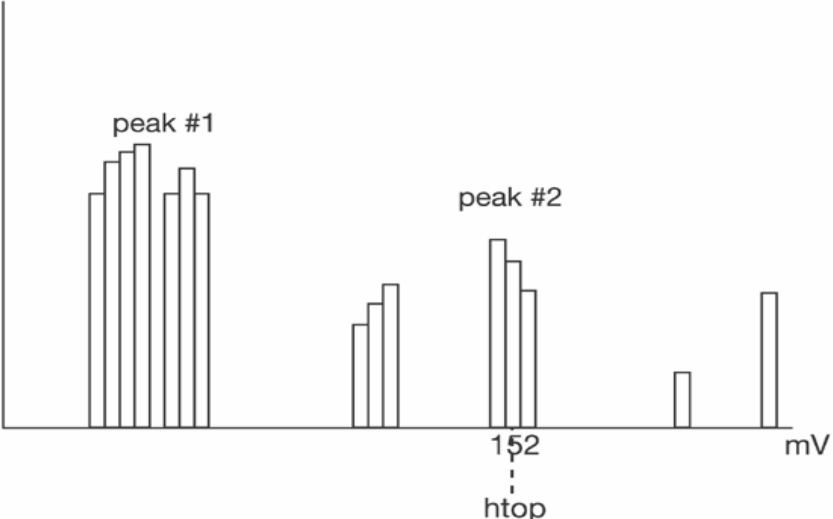
hist top	Histogram Top
Definition:	The value of the rightmost of the two most populated peaks in a histogram. This parameter is useful for waveforms with two primary parameter values, such as TTL voltages, where htop would indicate the binary '1' voltage value.
Description:	The two highest histogram peaks are determined. The rightmost of the two identified peaks is then selected. The center of that peak is htop (center is the horizontal point where the population to the left is equal to the area to the right).
Example:	 <p>The example shows a histogram with two main clusters of bars. The first cluster, labeled 'peak #1', is on the left. The second cluster, labeled 'peak #2', is on the right and is the rightmost of the two most populated peaks. A vertical dashed line from the center of peak #2 meets the x-axis at the value 152, which is labeled 'htop'. The x-axis is labeled 'mV'.</p>

maxp	Maximum Population																
Definition:	The count (vertical value) of the highest population bin in a histogram.																
Description:	Each bin between the parameter cursors is examined for its count. The highest count is returned as maxp.																
Example:	<p>The histogram displays the following data points:</p> <table border="1"> <thead> <tr> <th>mV Bin</th> <th>Count</th> </tr> </thead> <tbody> <tr> <td>1</td> <td>2</td> </tr> <tr> <td>2</td> <td>7</td> </tr> <tr> <td>3</td> <td>1</td> </tr> <tr> <td>4</td> <td>14</td> </tr> <tr> <td>5</td> <td>2</td> </tr> <tr> <td>6</td> <td>5</td> </tr> <tr> <td>7</td> <td>6</td> </tr> </tbody> </table>	mV Bin	Count	1	2	2	7	3	1	4	14	5	2	6	5	7	6
mV Bin	Count																
1	2																
2	7																
3	1																
4	14																
5	2																
6	5																
7	6																
	Here, maxp is 14.																

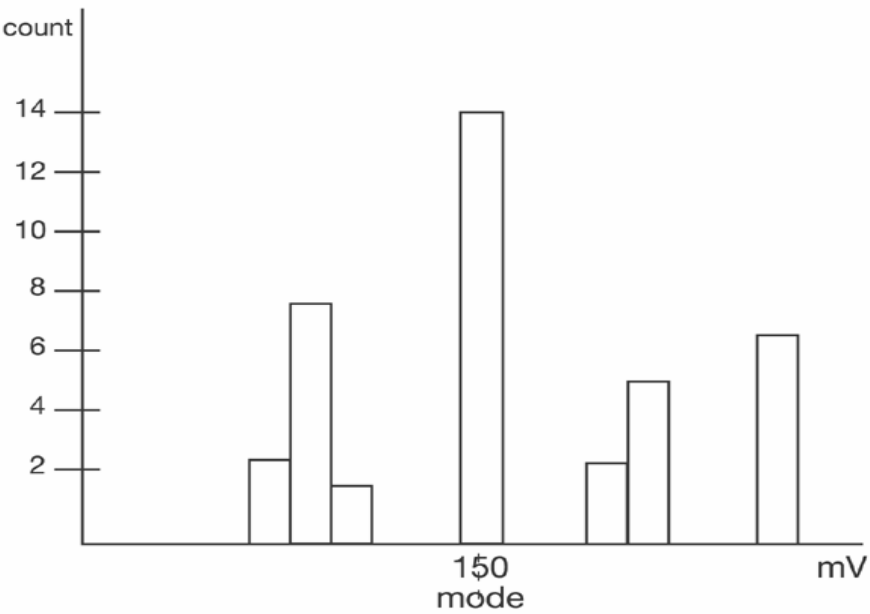
mode	Mode																
Definition:	The value of the highest population bin in a histogram.																
Description:	Each bin between the parameter cursors is examined for its population count. The leftmost bin with the highest count found is selected. Its center value is returned as mode.																
Example:	 <p>A histogram with a vertical axis labeled 'count' ranging from 0 to 14 in increments of 2, and a horizontal axis labeled 'mV'. There are seven bars of varying heights. The tallest bar is at 150 mV with a count of 14. Below this bar, the text '150 mode' is written. The other bars have counts of 2, 7, 1, 2, 5, and 6 from left to right.</p> <table border="1"><thead><tr><th>mV</th><th>count</th></tr></thead><tbody><tr><td>100</td><td>2</td></tr><tr><td>125</td><td>7</td></tr><tr><td>150</td><td>14</td></tr><tr><td>175</td><td>1</td></tr><tr><td>200</td><td>2</td></tr><tr><td>225</td><td>5</td></tr><tr><td>250</td><td>6</td></tr></tbody></table>	mV	count	100	2	125	7	150	14	175	1	200	2	225	5	250	6
mV	count																
100	2																
125	7																
150	14																
175	1																
200	2																
225	5																
250	6																
	Here, mode is 150 mV.																

pctl	Percentile
Definition:	Computes the horizontal data value that separates the data in a histogram such that the population on the left is a specified percentage `xx' of the total population. When the threshold is set to 50%, pctl is the same as hmedian.
Description:	The total population of the histogram is determined. Scanning from left to right, the population of each bin is summed until a bin that causes the sum to equal or exceed `xx%' of the population value is encountered. A ratio of the number of counts needed for `xx%' population/total bin population is then determined for the bin. The horizontal value of the bin at that ratio point of its range is found, and returned as pctl.
Example:	The total population of a histogram is 100. The histogram range is divided into 20 bins and `xx' is set to 25%. The population sum at the sixth bin from the left is 22. The population of the seventh is 9 and its sub-range is 6.1 to 6.4 V. The ratio of counts needed for 25% population to total bin population is:
	3 counts needed / 9 counts = 1/3.
	The value for pctl is:
	$6.1 \text{ volts} + .33 * (6.4 - 6.1) \text{ volts} = 6.2 \text{ volts.}$

pks	Peaks
Definition:	The number of peaks in a histogram.
Description:	The instrument analyzes histogram data to identify peaks from background noise and histogram binning artifacts such as small gaps.
	Peak identification is a 3-step process:
	<ol style="list-style-type: none">1. The mean height of the histogram is calculated for all populated bins. A threshold (T1) is calculated from this mean, where: $T1 = \text{mean} + 2 \sqrt{\text{mean}}$2. A second threshold is determined based on all populated bins under T1 in height, where: $T2 = \text{mean} + 2 * \text{sigma}$ and where sigma is the standard deviation of all populated bins under T1.3. Once T2 is defined, the histogram distribution is scanned from left to right. Any bin that crosses above T2 signifies the existence of a peak. Scanning continues to the right until one bin or more crosses below T2. However, if the bins cross below T2 for less than a hundredth of the histogram range, they are ignored, and scanning continues in search of peaks that cross under T2 for more than a hundredth of the histogram range. Scanning goes on over the remainder of the range to identify additional peaks. Additional peaks within a fiftieth of the range of the populated part of a bin from a previous peak are ignored.
	NOTE: If the number of bins is set too high, a histogram may have many small gaps. This increases sigma and, thereby, T2. In extreme cases, it can prevent determination of a peak, even if one appears to be present to the eye.
Example:	Here the two peaks have been identified. The peak with the highest population is peak #1.

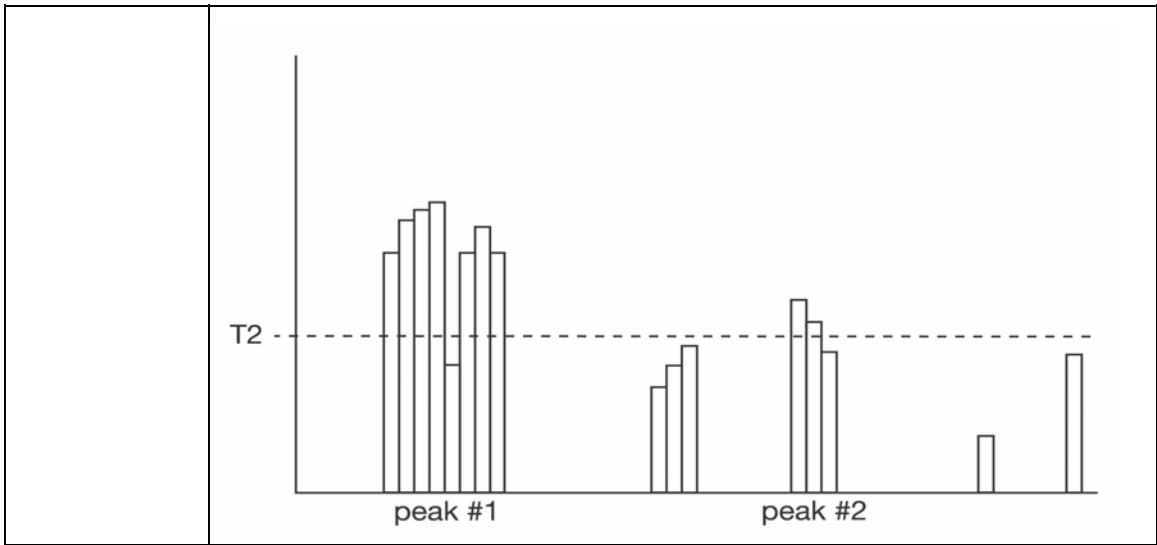

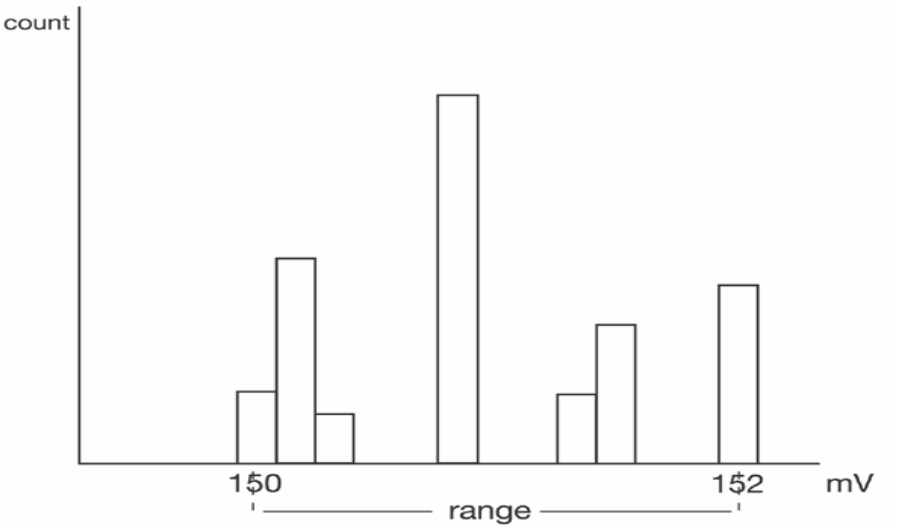
range	Range
Definition:	Computes the difference between the value of the rightmost and that of the leftmost populated bin.
Description:	The rightmost and leftmost populated bins are identified. The difference in value between the two is returned as the range.
Example:	 <p>A histogram with a vertical axis labeled 'count' and a horizontal axis labeled 'mV'. The horizontal axis has two specific values marked: 150 and 152. A horizontal line with arrows at both ends spans from 150 to 152, labeled 'range'. There are seven bars in total. The first bar is at 150. The second bar is taller than the first. The third bar is shorter than the second. The fourth bar is the tallest. The fifth bar is shorter than the fourth. The sixth bar is taller than the fifth. The seventh bar is taller than the sixth.</p>
	In this example, range is 2 mV.

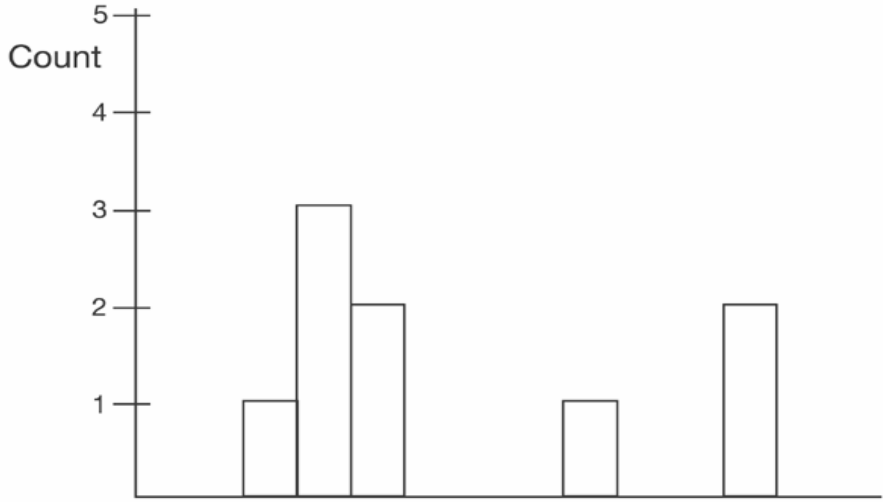
totp	Total Population																
Definition:	Calculates the total population of a histogram between the parameter cursors.																
Description:	The count for all populated bins between the parameter cursors is summed.																
Example:	 <p>The histogram shows the following counts for each bin:</p> <table border="1"><thead><tr><th>Bin</th><th>Count</th></tr></thead><tbody><tr><td>1</td><td>1</td></tr><tr><td>2</td><td>3</td></tr><tr><td>3</td><td>2</td></tr><tr><td>4</td><td>0</td></tr><tr><td>5</td><td>1</td></tr><tr><td>6</td><td>0</td></tr><tr><td>7</td><td>2</td></tr></tbody></table>	Bin	Count	1	1	2	3	3	2	4	0	5	1	6	0	7	2
Bin	Count																
1	1																
2	3																
3	2																
4	0																
5	1																
6	0																
7	2																
	The total population of this histogram is 9.																

xapk	X Coordinate of xxth Peak
Definition:	Returns the value of the xx th peak that is the largest by area in a histogram.
Description:	First the peaks in a histogram are determined and ranked in order of total area (for a discussion on how peaks are identified see the description for the pks parameter). The center of the n th ranked peak (the point where the area to the left is equal to the area to the right), where n is selected by you, is then returned as xapk.
Example:	The rightmost peak is the largest, and is thus ranked first in area (1). The leftmost peak, although higher, is ranked second in area (2). The lowest peak is also the smallest in area (3).

Histogram Theory of Operation

An understanding of statistical variations in parameter values is needed for many waveform parameter measurements. Knowledge of the average, minimum, maximum, and standard deviation of the parameter may often be enough, but in many cases you may need a more detailed understanding of the distribution of a parameter's values.

Histograms allow you to see how a parameter's values are distributed over many measurements. They do this by dividing a range of parameter values into sub-ranges called bins. A count of the number of parameter values (events) that fall within ranges of the bin itself is maintained for each bin.

While such a value range can be infinite, for practical purposes it need only be defined as large enough to include any realistically possible parameter value. For example, in measuring TTL high-voltage values a range of ± 50 V is unnecessarily large, whereas one of $4\text{ V} \pm 2.5\text{ V}$ is more reasonable. It is the 5 V range that is then subdivided into bins. And if the number of bins used were 50, each would have a range of $5\text{ V}/50$ bins or 0.1 V/bin . Events falling into the first bin would then be between 1.5 V and 1.6 V. While the next bin would capture all events between 1.6 V and 1.7 V, and so on.

After a process of several thousand events, the bar graph of the count for each bin (its histogram) provides a good understanding of the distribution of values. Histograms generally use the 'x' axis to show a bin's sub-range value, and the 'y' axis for the count of parameter values within each bin. The leftmost bin with a non-zero count shows the lowest parameter value measurements. The vertically highest bin shows the greatest number of events falling within its sub-range.

The number of events in a bin, peak or a histogram is referred to as its population. The following figure shows a histogram's highest population bin as the one with a sub-range of 4.3 to 4.4 V (which is to be expected of a TTL signal).

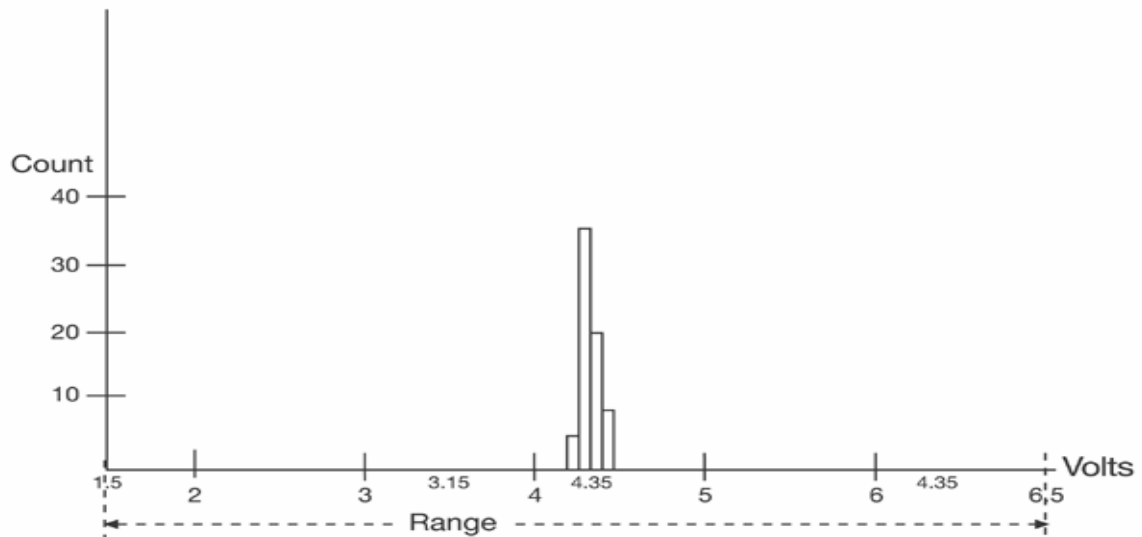

The lowest-value bin with events is that with a sub-range of 3.0 to 3.1 V. As TTL high voltages need to be greater than 2.5 V, the lowest bin is within the allowable tolerance. However, because of its proximity to this tolerance and the degree of the bin's separation from all other values, additional investigation may be required.

Scope Process

The instrument generates histograms of the parameter values of input waveforms. But first, you must define the following:

- The parameter to be histogrammed

- The trace on which the histogram is to be displayed
- The maximum number of parameter measurement values to be used in creating the histogram
- The measurement range of the histogram
- The number of bins to be used

Some of these are pre-defined but can be changed. Once they are defined, the oscilloscope is ready to make the histogram. The sequence for acquiring histogram data is as follows:

1. Trigger
2. Waveform acquisition
3. Parameter calculations
4. Histogram update
5. Trigger re-arm

If you set the timebase for non-segmented mode, a single acquisition occurs prior to parameter calculations. However, in Sequence mode an acquisition for each segment occurs prior to parameter calculations. If the source of histogram data is a memory, saving new data to memory effectively acts as a trigger and acquisition. Because updating the screen can take much processing time, it occurs only once a second, minimizing trigger dead time. Under remote control the display can be turned off to maximize measurement speed.

Parameter Buffer

The oscilloscope maintains a circular parameter buffer of the last 20,000 measurements made, including values that fall outside the set histogram range. If the maximum number of events to be used for the histogram is a number 'N' less than 20,000, the histogram will be continuously updated with the last 'N' events as new acquisitions occur. If the maximum number is greater than 20,000, the histogram will be updated until the number of events is equal to 'N.' Then, if the number of bins or the histogram range is modified, the scope will use the parameter buffer values to redraw the histogram with either the last 'N' or 20,000 values acquired -- whichever is the lesser. The parameter buffer thereby allows histograms to be redisplayed, using an acquired set of values and settings that produce a distribution shape with the most useful information.

In many cases the optimal range is not readily apparent. So the scope has a powerful range finding function. If required it will examine the values in the parameter buffer to calculate an optimal range and redisplay the histogram using it. The instrument will also give a running count of the number of parameter values that fall within, below, or above the range. If any values fall below or above the range, the range finder can then recalculate to include these parameter values, as long as they are still within the buffer.

Capture of Parameter Events

The number of events captured per waveform acquisition or display sweep depends on the parameter type. Acquisitions are initiated by the occurrence of a trigger event. Sweeps are equivalent to the waveform captured and displayed on an input channel (1, 2, or 3 or 4). For non-segmented waveforms an acquisition is identical to a sweep. Whereas for segmented

waveforms an acquisition occurs for each segment and a sweep is equivalent to acquisitions for all segments. Only the section of a waveform between the parameter cursors is used in the calculation of parameter values and corresponding histogram events.

The following table provides a summary of the number of histogram events captured per acquisition or sweep for each parameter, and for a waveform section between the parameter cursors.

Parameters	Number of Events Captured
duty, freq, period, width, time@lev, f@level, f80-20%, fall, r@level, r20-80%, rise	All events in the acquisition
ampl, area, base, cmean, cmedian, crms, csdev, cycles, delay, maximum, mean, minimum, nbph, nbpw, over+, over-, pkpk, npts, rms, sdev, dly	One event per acquisition

Histogram Parameters (XMAP and JTA2 Options)

Once a histogram is defined and generated, measurements can be performed on the histogram itself. Typical of these are the histogram's

- average value, standard deviation
- most common value (parameter value of highest count bin)
- leftmost bin position (representing the lowest measured waveform parameter value)
- rightmost bin (representing the highest measured waveform parameter value)

Histogram parameters are provided to enable these measurements. Available through selecting "Statistics" from the "Category" menu, they are calculated for the selected section between the parameter cursors:

fwhm full width (of largest peak) at half the maximum bin

fwxx full width (of largest peak) at xx% the maximum bin

hist ampl histogram amplitude between two largest peaks

hist base histogram base or leftmost of two largest peaks

hist max value of the highest (right-most) populated bin in a histogram

hist mean average or mean value of data in the histogram

hist median value of the x-axis of a histogram that divides the population into two equal halves

hist min value of the lowest (left-most) populated bin in a histogram

hist rms rms value of data in histogram

hist sdev standard deviation of values in a histogram

hist top histogram top or rightmost of two largest peaks

max populate population of most populated bin in histogram

mode data value of most populated bin in histogram

percentile data value in histogram for which specified 'x'% of population is smaller

peaks number of peaks in histogram

pop @ x population of bin for specified horizontal coordinate

range difference between highest and lowest data values

total pop total population in histogram

x at peak x-axis position of specified largest peak

Histogram Peaks

Because the shape of histogram distributions is particularly interesting, additional parameter measurements are available for analyzing these distributions. They are generally centered around one of several peak value bins, known, with its associated bins, as a histogram peak.

Example: In the following figure, a histogram of the voltage value of a five-volt amplitude square wave is centered around two peak value bins: 0 V and 5 V. The adjacent bins signify variation due to noise. The graph of the centered bins shows both as peaks.

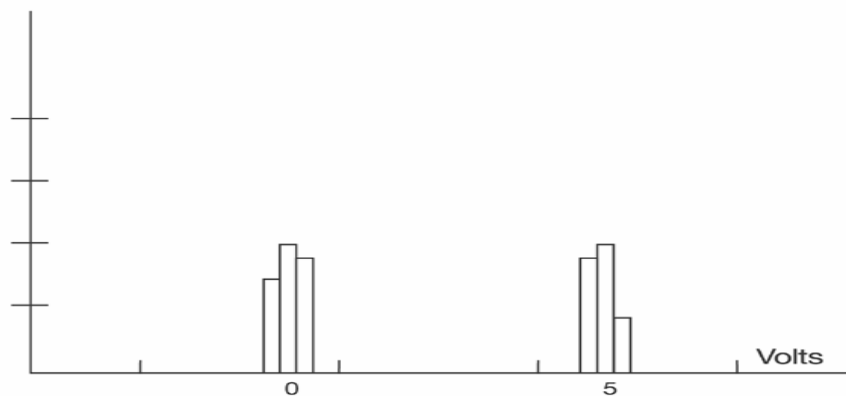

Determining such peaks is very useful because they indicate dominant values of a signal. However, signal noise and the use of a high number of bins relative to the number of parameter values acquired, can give a jagged and spiky histogram, making meaningful peaks hard to distinguish. The scope analyzes histogram data to identify peaks from background noise and histogram definition artifacts such as small gaps, which are due to very narrow bins.

Binning and Measurement Accuracy

Histogram bins represent a sub-range of waveform parameter values, or events. The events represented by a bin may have a value anywhere within its sub-range. However, parameter measurements of the histogram itself, such as average, assume that all events in a bin have a single value. The scope uses the center value of each bin's sub-range in all its calculations. The greater the number of bins used to subdivide a histogram's range, the less the potential deviation between actual event values and those values assumed in histogram parameter calculations.

Nevertheless, using more bins may require that you perform a greater number of waveform parameter measurements, in order to populate the bins sufficiently for the identification of a characteristic histogram distribution.

In addition, very fine grained binning will result in gaps between populated bins that may make it difficult to determine peaks.

The oscilloscope's 20,000-parameter buffer is very effective for determining the optimal number of bins to be used. An optimal bin number is one where the change in parameter values is insignificant, and the histogram distribution does not have a jagged appearance. With this buffer, a histogram can be dynamically redisplayed as the number of bins is modified by the user. In addition, depending on the number of bins selected, the change in waveform parameter values can be seen.

WAVEFORM MEASUREMENTS

Measuring with Cursors





Cursors are important tools that aid you in measuring signal values. Cursors are markers --- lines, cross-hairs, or arrows --- that you can move around the grid or the waveform itself. Use cursors to make fast, accurate measurements and to eliminate guesswork. There are two basic types:

- **Horiz(ontal)** (generally Time or Frequency) cursors are markers that you move horizontally along the waveform. Place them at a desired location along the time axis to read the signal's amplitude at the selected time.
- **Vert(ical)** (Voltage) cursors are lines that you move vertically on the grid to measure the amplitude of a signal.

Cursors Setup

Cursor Measurement Icons

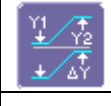
The **Readout** icons depict what is being measured for each measurement mode.

	Each cursor locates a point on the waveform. The cursor values can be read in the descriptor label for the trace. Use the Position data entry fields at the right side of the dialog to place the cursors precisely.
	This is the difference in Y values. The value can be read in the descriptor label for the trace.
	Displays absolute and delta cursors together.
	This gives the slope between cursors.

If there are non-time-domain waveforms displayed, there will also be a menu offering choices of x-axis units: **s** or **Hz**, for example.

Cursors Setup

Quick Display

At any time, you can change the display of cursor types (or turn them off) without invoking the "Cursors Setup" dialog as follows:

1. In the menu bar, touch **Cursors**, then **Off**, **Abs Horizontal**, **Rel Horizontal**, **Abs Vertical**, or **Rel Vertical**.
2. The cursors displayed will assume the positions previously set up. If you want to change their position or measurement mode, in the menu bar touch **Cursors**, then **Cursors Setup** in the drop-down menu.

Full Setup

1. In the menu bar, touch **Cursors**, then **Cursors Setup**. The "Standard Cursors" dialog opens.
2. In the dialog area, touch the **Cursors On** check box to display them.
3. Touch one of the **Horizontal** or **Vertical** mode buttons: **Relative** or **Absolute**.
4. If you chose a Relative mode, also touch a readout parameter button: Y position, delta Y, or slope.
5. If you chose a Relative mode, touch inside the **Position 1** and **Position 2** data entry fields and type in a value for each cursor. You can also use the Cursors knobs on the front panel to place the cursors. If you chose an Absolute mode, do the same for your single cursor.
6. If you chose a Relative mode and you would like both cursors to move in unison as you adjust the position, touch the **Track** check box to enable tracking.

Overview of Parameters

Parameters are measurement tools that determine a wide range of waveform properties. Use them to automatically calculate many attributes of your waveform, like rise-time, rms voltage, and peak-to-peak voltage, for example.

There are parameter modes for the amplitude and time domains, custom parameter groups, and parameters for pass and fail testing. You can make common measurements on one or more waveforms.

To Turn On Parameters

1. Touch **Measure** in the menu bar, then **Measure Setup...** in the drop-down menu.
2. Touch inside the **On** checkbox for each parameter you want to display.

Quick Access to Parameter Setup Dialogs

You can quickly gain access to a parameter setup dialog by touching the parameter list box below





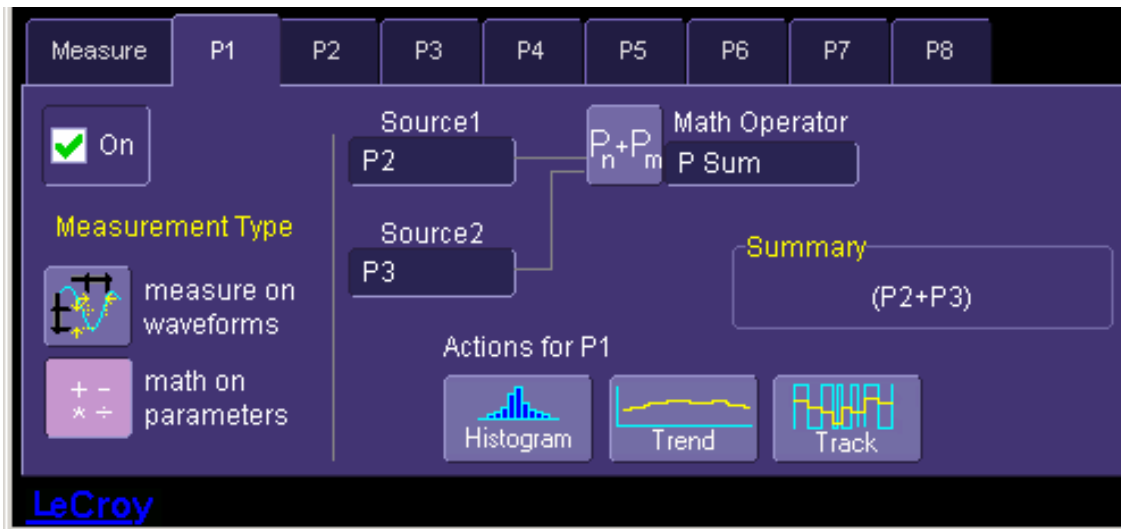

the grid. For example, touching within **P1** below the grid displays the setup dialog for P1:



Touching the row titles displays the top Measure dialog.

Status Symbols

Below each parameter appears a symbol that indicates the status of the parameter, as follows:

	A green check mark means that the scope is returning a valid value.
	A crossed-out pulse means that the scope is unable to determine top and base; however, the measurement could still be valid.
	A downward pointing arrow indicates an underflow condition.
	An upward pointing arrow indicates an overflow condition.
	An upward-and-downward pointing arrow indicates an underflow and overflow condition.

Using X-Stream Browser to Obtain Status Information

Example:

Here is a case of an overflow condition, in which the amplitude of the waveform cannot be determined:



1. Minimize the scope display by selecting File Minimize.
2. Touch the **X-Stream Browser** desktop icon to open the browser:



3. Touch the left scope icon ("Connect to a local X-Stream DSO device") in the X-Stream



Browser toolbar:

4. Select **Measure Parameter in error (P1) Out Result:**

XStream Browser - Online, browsing LeCroy.XStreamDSO

File Edit Help

Name	Value	Type
ExtendedStatus	0	Property
FirstEventTime	10699933597047.0523	Property
HorizontalResolution	0.000000000001	Property
HorizontalUnits	5	Property
LastEventTime	10699933597047.0523	Property
NumFrameDimensions	2	Property
Status	0.0098	Property
StatusDescription	Data overflow, Greater than, Not a pulse.	Property
UpdateTime	10699933598577.582	Property
Value	0.289474614623108	Property
ValueArray	(Array)	Property
VerticalResolution	2.20972988261915E-03	Property
VerticalUnits	V	Property

5. Read the status information in line **StatusDescription**.

Statistics

By touching the **Statistics On** checkbox in the "Measure" dialog, you can display statistics for standard vertical or horizontal parameters, or for custom parameters. The statistics that are displayed are as follows:

value (last)
mean
min.
max.
sdev
num

The values displayed in the **num** row is the number of measurements computed. For any parameter that computes on an entire waveform (like edge@level, mean, minimum, maximum, etc.) the value displayed represents the number of sweeps.

For any parameter that computes on every event, the value displayed is equal to the number of events per acquired waveform. If x waveforms were acquired, the value represents x times the number of cycles per waveform. Also, the "value" is equal to the measurement of the last cycle on the last acquisition.

To Apply a Measure Mode

1. In the menu bar, touch **Measure**, then **Measure Setup**.
2. Choose a **Measure Mode** from the dialog. The parameters are displayed below the grid.

Measure Modes

The selections for Measure Mode allow you to quickly apply parameters for standard vertical and standard horizontal setups, and custom setups.

Standard Vertical Parameters

These are the default Standard Vertical Parameters:

Vertical
mean
sdev
max.
min.
ampl

pkpk
top
base

Standard Horizontal Parameters

These are the default Standard Horizontal Parameters:

Horizontal
freq
period
width
rise
fall
delay
duty
npoints

My Measure

You can choose to customize up to eight parameters by touching **My Measure**.

Parameter Math (XMath or XMAP option required)

The instrument gives you the ability to perform arithmetic operations (addition, subtraction, multiplication, division) on the results of two parameter measurements. Alternatively, you can apply math to a single parameter (for example, invert). By customizing parameters in this way, you can effectively extend the range of parameter measurements based on your particular needs.

Logarithmic Parameters

The parameter math feature prevents multiplication and division of parameters that return logarithmic values. These parameters are as follows:

- auto-correlation signal-to-noise ratio (ACSN)
- narrow-band power (NBPW)
- media signal-to-noise ratio (MSNR)
- residual signal-to-noise ratio (RSNR)
- top-to-base ratio when the units are in dB (TBR)

Excluded Parameters

Parameters that are already the result of parameter math operations are excluded. If they are included in a remote control setup command, an error message is generated and the setup canceled.

- Excluded parameters are as follows:
- delta clock-to-data near (DC2D)
- delta clock-to-data next (DC2DPOS)
- delta clock-to-data previous (DC2DNEG)
- delta delay (DDLTY)
- delta time at level (DTLEV)
- phase (PHASE)
- resolution (RES)
- mTnTmT shift (BEES)
- mTnTmT shift sigma (BEESS)
- mTnTmT shift sigma - list (BEESS)

Parameter Script Parameter Math

In addition to the arithmetic operations, the Parameter Math feature allows you to use VBScript or JavaScript to write your own script for one or two measurements and produce a result that suits your needs. Code entry is done in the Script Editor window directly on the instrument. You can also import an existing script.

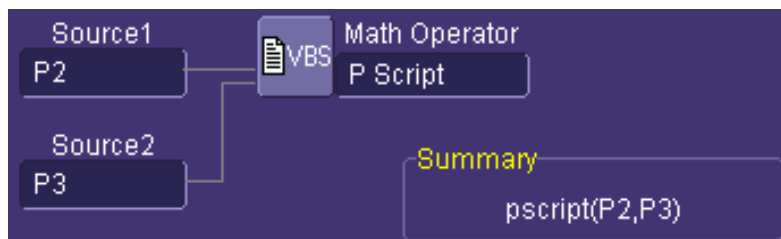

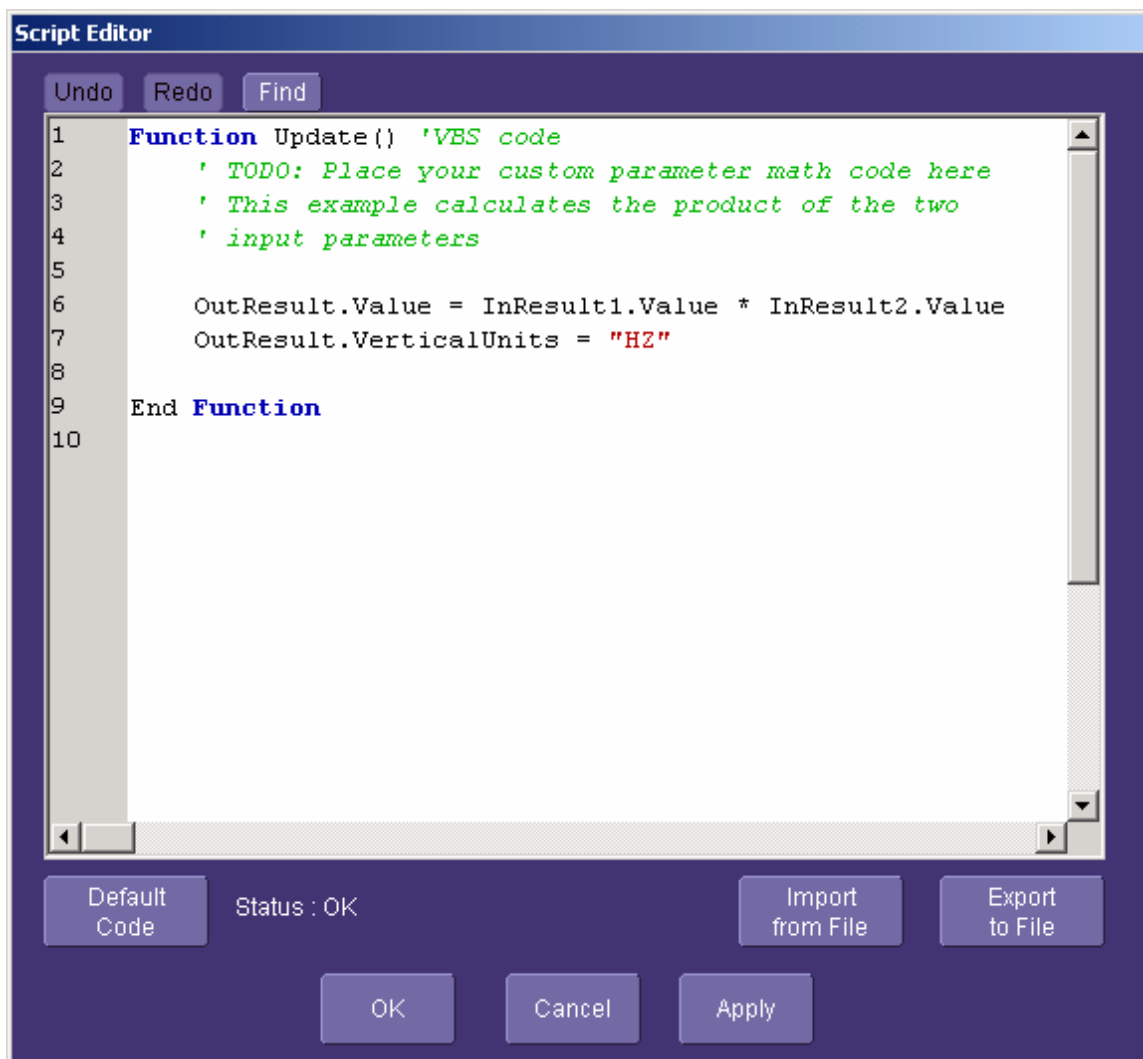



Param Script vs. P Script

Param Script is a VBScript or JavaScript that operates on one or two *waveforms* and outputs a parameter measurement, as shown in the figure below. P Script, on the other hand, is another VBScript or JavaScript that takes as input one or two *parameters* and performs a math operation on them to produce another parameter output.

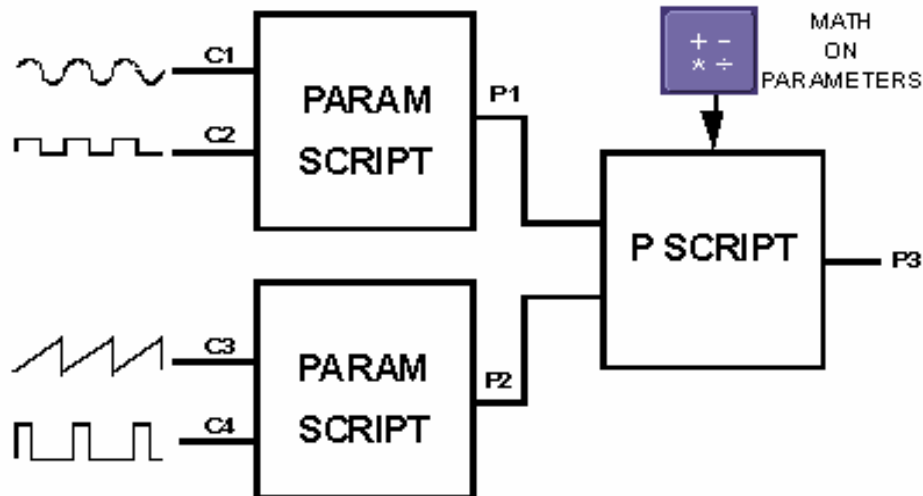
The inputs to Param Script can also be math (F1-Fx) or memory (M1-Mx) traces. The inputs to P Script can be the results of any parameter measurement, not necessarily Param Script.



To Set Up Parameter Math

1. Touch **Measure** in the menu bar, then **Measure Setup...** in the drop-down menu.
2. Touch the **My Measure** button in the "Measure" dialog.
3. Touch the **Px** tab for the parameter to which you want to apply parameter math.
4. In the "Px" dialog, touch the **math on parameters** button . The **Source** field will expand to two fields.
5. Touch inside the **Source1** and **Source2** fields and select the parameters you want to apply math to (P1 to Px). If you are applying math to a single parameter (for example, invert), just touch inside the **Source1** field and select a parameter (P1 to Px).
6. Touch inside the **Math Operator** field and select a math operation from the **Select Measurement** menu. If you select an operation that requires two input parameters, the **Source** field will expand to two fields.

To Set Up Parameter Script Math

1. Touch **Measure** in the menu bar, then **Measure Setup...** in the drop-down menu.
2. Touch the **My Measure** button in the "Measure" dialog.
3. Touch the **Px** tab for the parameter to which you want to apply parameter math.
4. In the "Px" dialog, touch the **math on parameters** button . The **Source** field will expand to two fields.
5. Touch inside the **Source1** and **Source2** fields and select the parameters you want to apply

math to (P1 to Px). If you are applying math to a single parameter (for example, invert), just touch inside the **Source1** field and select a parameter (P1 to Px).

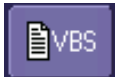
6. Touch inside the **Math Operator** field and select  **P Script** from the **Select Measurement** menu.
7. In the "Script Math" dialog, touch inside the Script Language field and select either **VBScript** or **JScript** from the pop-up menu.
8. Touch the **Edit Code** button; the Script Editor window opens. You can enter code in this window or call up an existing script from a file storage location. If you create your script in this window, you can then export it and save it to file.

Measure Gate

Using Measure Gate, you can narrow the span of the waveform on which to perform parameter measurements, allowing you to focus on the area of greatest interest. You have the option of dragging the gate posts horizontally along the waveform, or specifying a position down to hundredths of a division. The default starting positions of the gate posts are 0 div and 10 div, which coincide with the left and right ends of the grid. The gate, therefore, initially encloses the entire waveform.

Note: If you have Grid On Top enabled, you will not see the gate posts in their default position at each end of the grid. But if you touch either end of the grid, a drag cursor  will appear, indicating that you have control of the post and can now drag it.

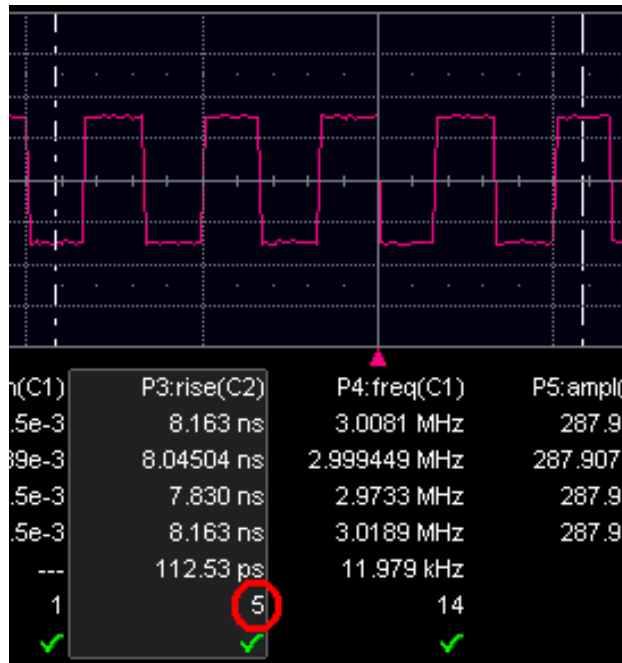

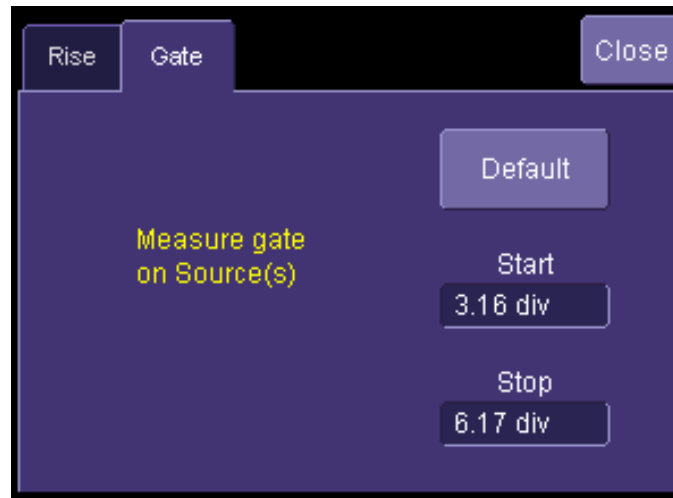

In this example, you can see that the Measure Gate includes only five rising edges. Therefore, parameter calculations for rise time are performed only on the five pulses bounded by the gate posts. The position of the gate posts is shown in the **Start** and **Stop** fields in the accompanying dialog.

To Set Up Measure Gate

1. In the menu bar, touch **Measure Setup...**
2. Touch the **Px** tab for the parameter you want to gate. A mini-dialog to the right of the main setup dialog opens.

Note: If you already have the parameter of interest set up, you can simply touch the parameter directly below the grid:

P1:per@lv(C1)
332.3 ns
333.332 ns
327.4 ns
339.2 ns
1.465 ns
10.458e+3
✓

Example Parameter Readout

3. Touch inside the **Start** data entry field and enter a value, using the pop-up numeric keypad. Or, you can simply touch the leftmost grid line and drag the gate post to the right.
4. Touch inside the **Stop** data entry field and enter a value, using the pop-up numeric keypad. Or, you can simply touch the rightmost grid line and drag the gate post to the left.

Help Markers

Help Markers clarify parameter measurements by displaying movable cursors and a visual representation of what is being measured. For the "at level" parameters, Help Markers make it easier to see where your waveform intersects the chosen level. This feature also displays the hysteresis band that you have set about that level.

You also have the option, by means of an **Always On** checkbox, to leave the Help Markers displayed after you have closed the Help Markers setup dialog.

You have a choice of **Simple** or **Detailed** views of the markers:

- The **Simple** selection produces cursors and Measure Gate gate posts. The gate posts are independently placeable for each parameter.
- The **Detailed** selection produces cursors, Measure Gate gate posts, a label identifying the parameter being measured, and a level indicator and hysteresis band for "at level" parameters (not part of Standard Horizontal or Standard Vertical parameters).

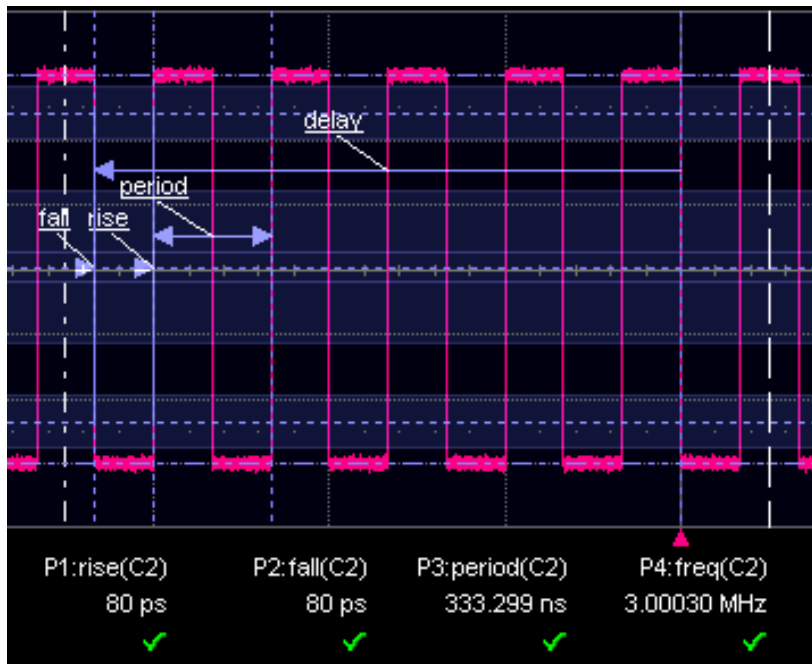

Standard Horizontal Parameter Help Markers

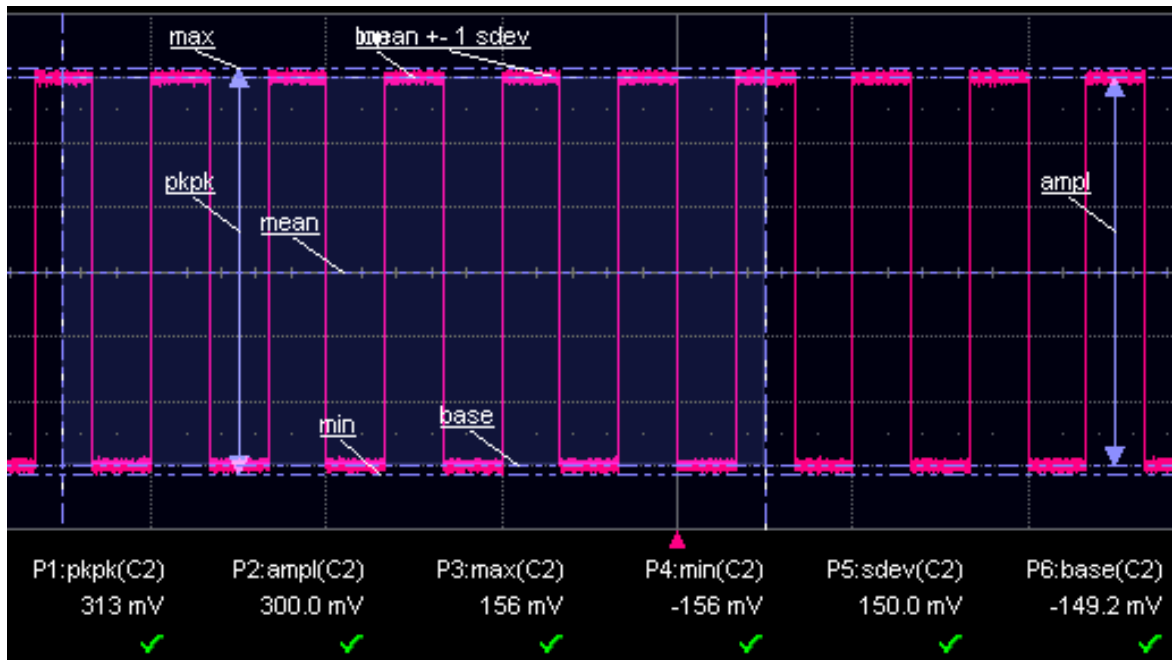

Standard Vertical Parameter Help Markers

To Set Up Help Markers

1. In the menu bar, touch **Measure Setup...**
2. Select a Measure Mode: **Std Vertical**, **Std Horizontal**, or **My Measure**.



3. Touch the **Show All** button to display Help Markers for every parameter being measured on the displayed waveform (C2 in the examples above).
4. Touch inside the **Help Markers** field and select **Simple**. The **Simple** selection produces cursors and Measure Gate gate posts. The gate posts are independently placeable for each parameter. or **Detailed**. The **Detailed** selection produces cursors, Measure Gate gate posts, a label identifying the parameter being measured, and a level indicator and hysteresis band for "at level" parameters..

Note: The choice of Simple or Detailed is applied to all parameters at the same time. That is, if you choose Simple markers for one parameter, all parameters will be displayed in this mode.

5. Touch the **Always On** checkbox if you want to continuously display Help Markers for this parameter.

To Turn Off Help Markers



1. Touch the **Clear All** button to turn off Help Markers for all parameters.
2. To turn off Help Markers for individual parameters, touch the **Px** tab for the parameter in question. Then uncheck the **Always On** checkbox. When you close this dialog, the Help Markers for this parameter will no longer be displayed.

To Customize a Parameter

From the Measure Dialog

1. Touch the **My Measure** button in the "Measure" dialog. The dialog presents you with a panel of eight preset parameters.
2. For each parameter, touch the **On** check box to enable the parameter listed.
3. If you want to change the parameter listed, or a measurement characteristic, touch the parameter button (**P1** for example) alongside the check box. A pop-up menu of parameters categorized by type appears. To display parameter icons only, touch the icon button



at the bottom of the menu. To display the icons in list form, along with an

explanation of each parameter, touch the list button . Use the Up/Down buttons to scroll through the list of icons.

4. When you make a selection from the parameter icon menu, the setup dialogs for that parameter appear. You can then change the waveform source and other conditions of the parameter.
5. If you are setting up an "@level" parameter, make selections for **Level type** (percent or absolute), **Slope** (positive, negative, both), and **Hysteresis** level.
6. Touch the **Gate** tab, and set the position of the gate posts.

From a Vertical Setup Dialog

1. In the "Cx Vertical Adjust" dialog, touch the Measure button .
2. Select a parameter from the pop-up menu. (The **Actions for trace** source defaults to the channel or trace whose dialog is open. If a parameter, it goes into the next "available" parameter, or the last one if all are used.)
3. Select another parameter or touch **Close**.

From a Math Setup Dialog

1. In the "Fx" dialog, touch the Measure button .
2. Select a parameter from the pop-up menu. (The **Actions for trace** source defaults to the channel or trace whose dialog is open. If a parameter, it goes into the next "available" parameter, or the last one if all are used.)
3. Select another parameter or touch **Close**.

Parameter Calculations

Parameters and How They Work

Determining Top and Base Lines

Proper determination of the top and base reference lines is fundamental for ensuring correct parameter calculations. The analysis begins by computing a histogram of the waveform data over the time interval spanned by the left and right time cursors. For example, the histogram of a waveform transitioning in two states will contain two peaks (see Figure 1). The analysis will attempt to identify the two clusters that contain the largest data density. Then the most probable state (centroids) associated with these two clusters will be computed to determine the top and base reference levels: the top line corresponds to the top and the base line to the bottom centroid.

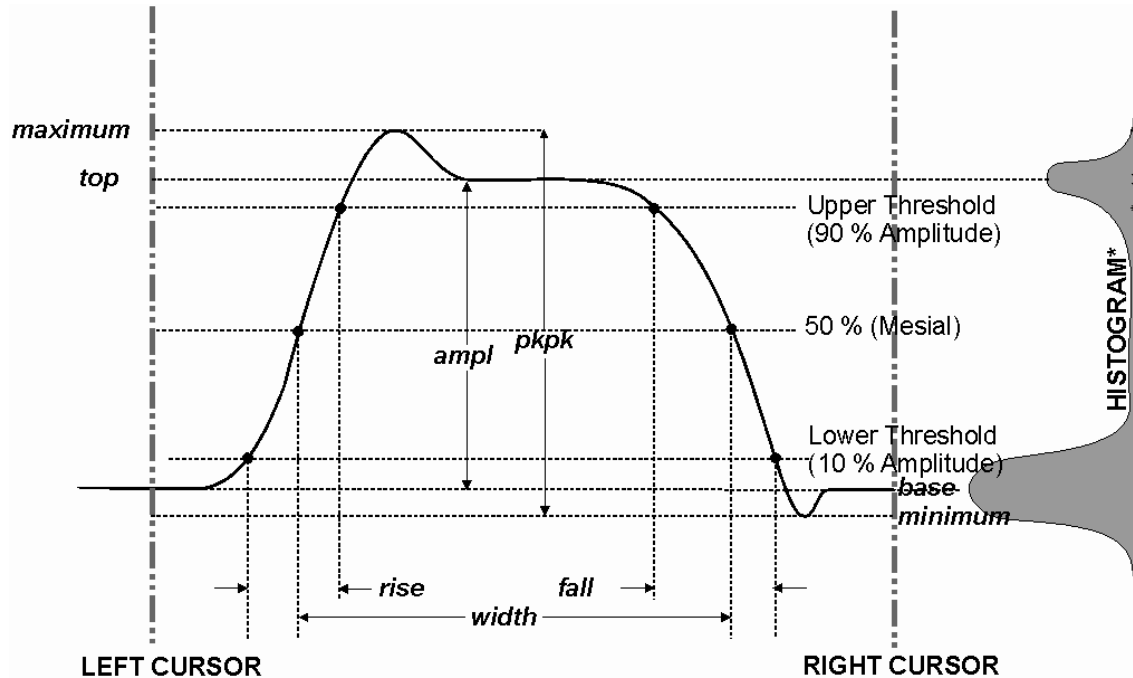

Figure 1

Determining Rise and Fall Times

Once top and base are estimated, calculation of the rise and fall times is easily done (see Figure 1). The 90% and 10% threshold levels are automatically determined by the DDA-5005A, using the amplitude (ampl) parameter.

Threshold levels for rise or fall time can also be selected using absolute or relative settings (r@level, f@level). If absolute settings are chosen, the rise or fall time is measured as the time interval separating the two crossing points on a rising or falling edge. But when relative settings are chosen, the vertical interval spanned between the base and top lines is subdivided into a percentile scale (base = 0 %, top = 100 %) to determine the vertical position of the crossing points.

The time interval separating the points on the rising or falling edges is then estimated to yield the rise or fall time. These results are averaged over the number of transition edges that occur within the observation window.

Rising Edge Duration	$\frac{1}{M_r} \sum_{i=1}^{M_r} (Tr_i^{90} - Tr_i^{10})$
Falling Edge Duration	$\frac{1}{M_f} \sum_{i=1}^{M_f} (Tf_i^{10} - Tf_i^{90})$
<p>Where M_r is the number of leading edges found, M_f the number of trailing edges found, Tr_i^x the time when rising edge i crosses the $x\%$ level, Tf_i^x and the time when falling edge i crosses the $x\%$ level.</p>	

Determining Time Parameters

Time parameter measurements such as width, period and delay are carried out with respect to the mesial reference level (see Figure 2), located halfway (50%) between the top and base reference lines.

Time-parameter estimation depends on the number of cycles included within the observation window. If the number of cycles is not an integer, parameter measurements such as rms or mean will be biased. However, only the last value is actually displayed, the mean being available when statistics are enabled. To avoid these bias effects, the instrument uses cyclic parameters, including crms and cmean, that restrict the calculation to an integer number of cycles.

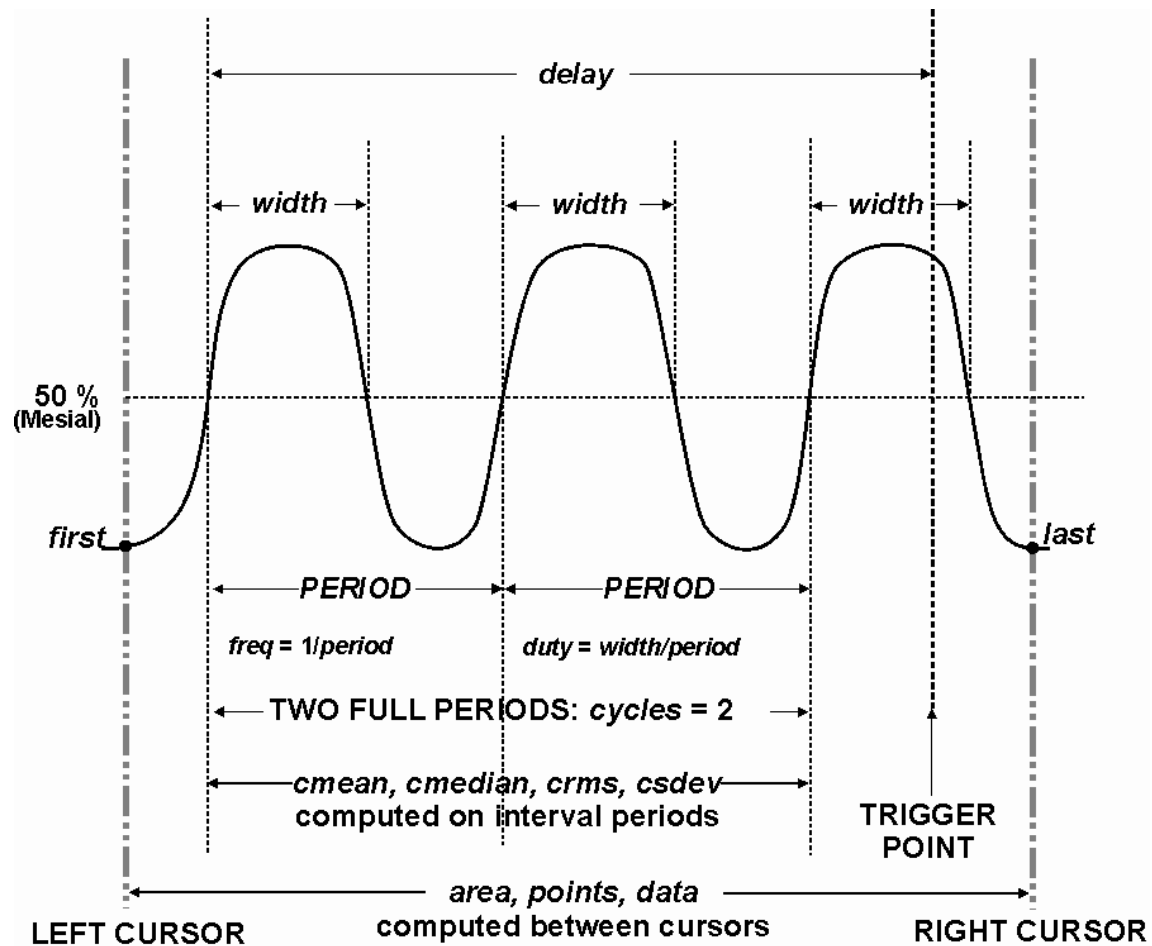

Figure 2

Determining Differential Time Measurements

The DDA-5005A enables accurate differential time measurements between two traces: for example, propagation, setup and hold delays (see Figure 3).

Parameters such as $\Delta c2d \pm$ require the transition polarity of the clock and data signals to be specified.

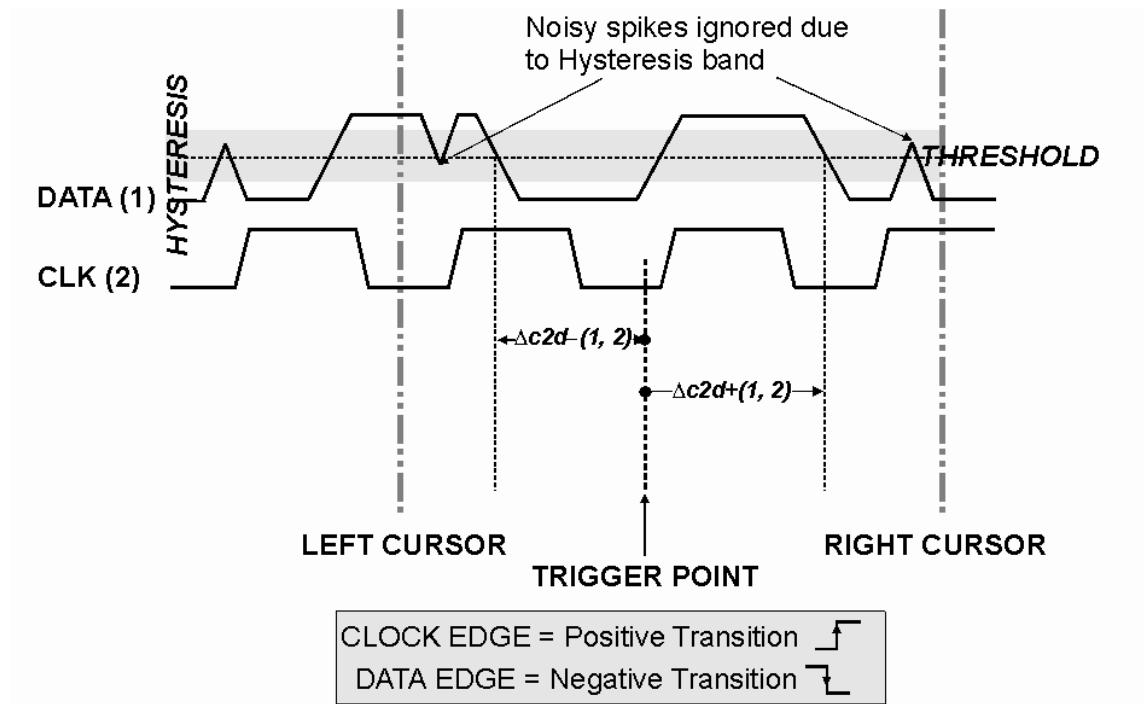

Figure 3

Moreover, a hysteresis range may be specified to ignore any spurious transition that does not exceed the boundaries of the hysteresis interval. In Figure 3, Delta c2d- (1, 2) measures the time interval separating the rising edge of the clock (trigger) from the first negative transition of the data signal. Similarly, Delta c2d+ (1, 2) measures the time interval between the trigger and the next transition of the data signal.

Level and Slope

For several time based measurements, you can choose positive, negative, or both slopes to begin parameter measurements. For two-input parameters, such as Dtime@level, you can specify the slope for each input, as well as the level and type (percent or absolute).

List of Parameters

The following table describes the instrument parameters. Availability of some parameters depends on the options installed. See the comments in the "Notes" column of the table.

Parameter	Description	Definition	Notes
100BT Fall	Fall time between 2 levels (upper-base, base-lower) of a 3-level signal (100BT)		Available with ENET option.
100BT Rise	Rise time between 2 levels (Lower-base, base-upper) of a 3-level signal (100BT)		Available with ENET option.
100BT TIE	Difference between the measured and ideal times at level between base and upper or lower levels of 100BT signal.		Available with ENET option.
100BT Tj	Total jitter from a TIE at level between base and upper or lower levels of 100BT signal.		Available with ENET option.
ACSN	Auto-correlation Signal-to-Noise provides a signal-to-noise ratio for periodic waveforms.		Available with DDM2 option. Standard in DDA-5005A.
AltNCycle	Alternate N-Cycle Plot. Timing of the transitions in the data waveform is measured for each transition and plotted as a function of the number of unit intervals over which the timing is measured. The N-cycle plot displays the mean or standard deviation of the edge placement in the waveform relative to each other (data to data) or to a reference clock (clock to data).		Available with ASDA option.
Amplitude	Measures the difference between upper and lower levels in two-level signals. Differs from pkpk in that noise, overshoot, undershoot, and ringing do not affect the measurement.	top - base	On signals not having two major levels (such as triangle or saw-tooth waves), returns same value as pkpk. Standard parameter.
Ampl asym	Amplitude asymmetry between taa+ and taa-	$1 \frac{ (taa+ - taa-) }{(taa+ - taa-)}$	Hysteresis argument used to discriminate levels from noise in data. Available with DDM2

			option. Standard in DDA-5005A.
Area	Integral of data: Computes area of waveform between cursors relative to zero level. Values greater than zero contribute positively to the area; values less than zero negatively.	Sum from first to last of data multiplied by horizontal time between points	Standard parameter..
Avg Power	Average power of the waveform		Available with SDA and SDM options. Standard in SDA100G scopes.
Base	Lower of two most probable states (higher is top). Measures lower level in two-level signals. Differs from min in that noise, overshoot, undershoot, and ringing do not affect measurement.	Value of most probable lower state	On signals not having two major levels (triangle or saw-tooth waves, for example), returns same value as min. Standard parameter.
Bit Rate	One over duration of one UI measured on an eye		Available with SDA option. Standard in SDA, SDA100G, and WaveExpert scopes.
CMAcP	PCI Express V TX-CM-ACp and V RX-CM-Acp		Available with PCIE option.
Cycles	Determines number of cycles of a periodic waveform lying between cursors. First cycle begins at first transition after the left cursor. Transition may be positive- or negative-going.	Number of cycles of periodic waveform	Standard parameter.
cyclic Mean	Cyclic mean: Computes the average of waveform data. Contrary to mean, computes average over an integral number of cycles, eliminating bias caused by fractional intervals.	Average of data values of an integral number of periods	Choose this parameter by selecting Mean from the parameter table, then touching the Cyclic checkbox. Standard parameter.

cyclic Median	Cyclic median: Computes average of base and top values over an integral number of cycles, contrary to median, eliminating bias caused by fractional intervals.	Data value for which 50% of values are above and 50% below	Choose this parameter by selecting Median from the parameter table, then touching the Cyclic checkbox. Standard parameter.
cyclic RMS	Cyclic root mean square: Computes square root of sum of squares of data values divided by number of points. Contrary to rms, calculation is performed over an integral number of cycles, eliminating bias caused by fractional intervals.	$\sqrt{\frac{1}{N} \sum_{i=1}^N (v_i)^2}$	Where: v_i denotes measured sample values, and N = number of data points within the periods found. Choose this parameter by selecting RMS from the parameter table, then touching the Cyclic checkbox. Standard parameter.
cyclic Std dev	Cyclic standard deviation: Standard deviation of data values from mean value over integral number of periods. Contrary to sdev, calculation is performed over an integral number of cycles, eliminating bias caused by fractional intervals.	$\sqrt{\frac{1}{N} \sum_{i=1}^N (v_i - \text{mean})^2}$	Where: v_i denotes measured sample values, and N = number of data points within the periods found. Choose this parameter by selecting Std dev from the parameter table, then touching the Cyclic checkbox. Standard parameter.
DCD	Amount of jitter due to duty cycle distortion		Available with SDA and ENET options. Standard in SDA and WaveExpert scopes.
DDj	Amount of data dependent jitter in a signal		Available with SDA option.
Delay	Time from trigger to transition: Measures time between trigger and first 50% crossing after left cursor. Can measure propagation delay between two signals by triggering on one and determining delay of other.	Time between trigger and first 50% crossing after left cursor	Standard parameter.

Delta delay	delay: Computes time between 50% level of two sources.	Time between midpoint transition of two sources	Standard parameter.
Dj Effective	Amount of deterministic jitter (estimated) in a signal		Available with SDA option.
DOV	Differential Output Voltage of a 100Base-T signal		Available with ENET option.
Dperiod@level	Adjacent cycle deviation (cycle-to-cycle jitter) of each cycle in a waveform		Reference levels and edge-transition polarity can be selected. Hysteresis argument used to discriminate levels from noise in data. Available with JTA2 and XMAP options. Standard in SDA100G scopes.
Droop FG	1000Base-T test mode 1 droop from F to G		Available with ENET option.
Droop HJ	1000Base-T test mode 1 droop from H to J		Available with ENET option.
Dtime@level	t at level: Computes transition between selected levels or sources.	Time between transition levels of two sources, or from trigger to transition level of a single source This measurement gives the time of the source 2 edge minus the time of the source 1 edge.	Reference levels and edge-transition polarity can be selected. Hysteresis argument used to discriminate levels from noise in data. Standard parameter.
Dtrig Time	Time from last trigger to this trigger		Standard in WaveRunner 6000A, WavePro 7000A, WaveMaster, and sampling scopes.
Duration	For single sweep waveforms, dur is 0; for sequence waveforms: time from first to last segment's trigger; for single segments of sequence waveforms: time from previous segment's to current segment's trigger; for waveforms produced by a history function: time from first to last accumulated waveform's trigger.	Time from first to last acquisition: for average, histogram or sequence waveforms	Standard parameter.

Duty@level	Percent of period for which data are above or below a specified level.		Reference levels and edge-transition polarity can be selected. Hysteresis argument used to discriminate levels from noise in data. Available with JTA2 and XMAP options.
Duty cycle	Duty cycle: Width as percentage of period.	width/period	Standard parameter.
Dwidth@level	Difference of adjacent width above or below a specified level.		Reference levels and edge-transition polarity can be selected. Hysteresis argument used to discriminate levels from noise in data. Available with JTA2 and XMAP options. Standard in SDA100G scopes.
Edge@level	Number of edges in waveform.		Reference levels and edge-transition polarity can be selected. Hysteresis argument used to discriminate levels from noise in data. Available with JTA2, USB2, SDA, and XMAP options. Standard in SDA100G and WavePro 7000A scopes.
Ext Ratio	Ratio of the power levels of an eye diagram		Available with SDA and SDM options. Standard in SDA, SDA100G, and WaveExpert scopes.

Excel	Performs measurements in Excel by transferring one or two waveforms and reading the resulting parameter value.		Available with XMAP and XDEV options. Standard on DDA-5005A scope. Excel must be loaded on the instrument.
Eye AC RMS	Root mean square of data within one UI		Standard in SDA and WaveExpert scopes.
Eye Amplitude	Difference of the levels of an eye diagram		Available with SDA and SDM options. Standard in SDA, SDA100G, and WaveExpert scopes.
Eye BER	Bit Error Rate estimated from an eye diagram		Available with SDA and SDM options. Standard in SDA, SDA100G, and WaveExpert scopes.
Eye Bit Rate	One over duration of one UI measured on an eye		Standard in SDA and WaveExpert scopes.
Eye Bit Time	Duration of one UI measured on an eye		Standard in SDA and WaveExpert scopes.
Eye Crossing	Level of the crossing in an eye diagram		Available with SDA and SDM options. Standard in SDA, SDA100G, and WaveExpert scopes.
Eye CrossN	Time of first crossing 50% level with negative edge of an eye relative to trigger or eye reference		Standard in SDA and WaveExpert scopes.
Eye CrossP	Time of first crossing 50% level with positive edge of an eye relative to trigger or eye reference		Standard in SDA and WaveExpert scopes.
Eye Cyc Area	The area under the mean persistence trace under first UI		Standard in SDA and WaveExpert scopes.
Eye Delay	Time of first crossing of an eye relative to trigger or eye reference		Standard in SDA and WaveExpert scopes.
Eye Delt Dly	Delay of crossing times between two eyes		Standard in SDA and WaveExpert scopes.
Eye FallTime	Fall time of the mean of persistence data		Standard in SDA and WaveExpert scopes.

Eye Height	Size of the vertical opening of an eye diagram		Available with SDA and SDM options. Standard in SDA, SDA100G, and WaveExpert scopes.
Eye Mean	Mean level of an eye		Standard in SDA and WaveExpert scopes.
Eye Open Fac	Eye opening factor measured within the eye aperture		Standard in SDA and WaveExpert scopes.
Eye OverN	Negative overshoot measured on an eye		Standard in SDA and WaveExpert scopes.
Eye OverP	Positive overshoot measured on an eye		Standard in SDA and WaveExpert scopes.
Eye Pk Noise	Peak-to-peak noise of a level of an eye diagram		Standard in SDA and WaveExpert scopes.
Eye PkPk Jit	Peak-to-peak jitter measured on eye persistence		Standard in SDA and WaveExpert scopes.
Eye Pulse Wid	The width of the eye measured at mid level		Standard in SDA and WaveExpert scopes.
Eye Q Factor	Q factor measured within the eye aperture		Available with SDA and SDM options. Standard in SDA, SDA100G, and WaveExpert scopes.
Eye RiseTime	Rise time of the mean of persistence data		Standard in SDA and WaveExpert scopes.
Eye RMS Jit	Root mean square jitter of an eye		Standard in SDA and WaveExpert scopes.
Eye SD Noise	The standard deviation of data on one eye level		Standard in SDA and WaveExpert scopes.
Eye SgToNoise	Signal to noise of an eye diagram		Standard in SDA and WaveExpert scopes.
Eye SupRatio	Suppression ratio of an eye		Standard in SDA and WaveExpert scopes.
Eye Width	Size of the horizontal opening of an eye diagram		Available with SDA and SDM options. Standard in SDA, SDA100G, and WaveExpert scopes.

Fall time	Fall time: Duration of falling edge from 90-10%.	Time at upper threshold minus	On signals not having two major levels (triangle or saw-tooth waves, for example), top and base can default to maximum and minimum, giving, however, less predictable results. Standard parameter.															
	<table border="1" style="width: 100%; border-collapse: collapse;"> <thead> <tr> <th>Thresh.</th> <th>Remote</th> <th>Lower Limit</th> <th>Upper Limit</th> <th>Default</th> </tr> </thead> <tbody> <tr> <td>Lower</td> <td>Low</td> <td>1%</td> <td>45%</td> <td>10%</td> </tr> <tr> <td>Upper</td> <td>High</td> <td>55%</td> <td>99%</td> <td>90%</td> </tr> </tbody> </table>	Thresh.		Remote	Lower Limit	Upper Limit	Default	Lower	Low	1%	45%	10%	Upper	High	55%	99%	90%	Time at lower threshold
	Thresh.	Remote		Lower Limit	Upper Limit	Default												
	Lower	Low		1%	45%	10%												
Upper	High	55%	99%	90%														
Threshold arguments specify two vertical values on each edge used to compute fall time. Formulas for upper and lower values:	averaged over each falling edge																	
<p>lower = lower thresh. x amp/100 + base</p> <p>upper = upper thresh. x amp/100 + base</p>																		
Fall 80-20%	Fall 80-20%: Duration of pulse waveform's falling transition from 80% to 20%, averaged for all falling transitions between the cursors.	Average duration of falling 80-20% transition	On signals not having two major levels (triangle or saw-tooth waves, for example), top and base can default to maximum and minimum, giving, however, less predictable results. Standard parameter.															
Fall@level	Fall at level: Duration of pulse waveform's falling edges between user-specified transition levels. See also Rise@level.	<p>Transition time for % or absolute levels of all falling edges.</p> <p>Enhanced version sets measurement calculations to use one of the following:</p> <p>Base & Top (% or absolute)</p> <p>Peak-Peak (%)</p> <p>0V-Min (%)</p>	On signals not having two major levels (triangle or saw-tooth waves, for example), top and base can default to maximum and minimum, giving, however, less predictable results. Standard parameter. Enhanced parameter available with EMC option.															
First	Indicates value of horizontal axis at left cursor.	Horizontal axis value at left cursor	Indicates location of left cursor. Cursors are interchangeable: for example, the left cursor may be moved to the right of the right cursor and first will give the location of the cursor															

			formerly on the right, now on left. Standard parameter.
Frequency	Frequency: Period of cyclic signal measured as time between every other pair of 50% crossings. Starting with first transition after left cursor, the period is measured for each transition pair. Values then averaged and reciprocal used to give frequency.	1/period	Standard parameter.
Freq@level	Frequency at a specific level and slope for every cycle in waveform.		Reference levels and edge-transition polarity can be selected. Hysteresis argument used to discriminate levels from noise in data. Available with JTA2 and XMAP options. Standard in SDA100G and WavePro 7000A scopes.
FWHM	Measures the width of the largest area histogram peak at half of the population of the highest peak.		Available with DDM2, JTA2, XMATH, XWAV, CAN02, SDA, and XMAP options. Standard in DDA-5005A, SDA100G, and WaveExpert scopes.
FWxx	Measures the width of the largest area histogram peak at xx% of the population of the highest peak.		Available with DDM2, JTA2, XMATH, XWAV, CAN02, SDA, and XMAP options. Standard in DDA-5005A, SDA100G, WaveExpert, and sampling scopes.
Half period	Half period of a waveform.		Reference levels and edge-transition polarity can be selected. Hysteresis argument used to discriminate levels from noise in

			<p>data.</p> <p>Available with JTA2, SDA, and XMAP options.</p> <p>Standard in SDA100G scopes.</p>
Hist ampl	Difference in value between the two most populated peaks in a histogram.		<p>Available with DDM2, JTA2, XMATH, XWAV, CAN02, SDA, and XMAP options.</p> <p>Standard in DDA-5005A, SDA100G, WaveExpert, and sampling scopes.</p>
Hist base	Value of the left-most of the two most populated histogram peaks.		<p>Available with DDM2, JTA2, XMATH, XWAV, CAN02, SDA, and XMAP options.</p> <p>Standard in DDA-5005A, SDA100G, WaveExpert, and sampling scopes.</p>
Hist maximum	Value of the highest (right-most) populated bin in a histogram.		<p>Available with DDM2, JTA2, XMATH, XWAV, CAN02, SDA, and XMAP options.</p> <p>Standard in DDA-5005A, SDA100G, WaveExpert, and sampling scopes.</p>
Hist Max Pop	Peak with maximum population in a histogram.		<p>Available with DDM2, JTA2, XMATH, XWAV, CAN02, SDA, and XMAP options.</p> <p>Standard in DDA-5005A, SDA100G, WaveExpert, and sampling scopes.</p>
Hist mean	Average or mean value of data in the histogram.		<p>Available with DDM2, JTA2, XMATH, XWAV, CAN02, SDA, and XMAP options.</p> <p>Standard in DDA-5005A, SDA100G, and WaveExpert</p>

			scopes.
Hist median	Value of the "X" axis of a histogram that divides the population into two equal halves.		Available with DDM2, JTA2, XMATH, XWAV, CAN02, SDA, and XMAP options. Standard in DDA-5005A, SDA100G, WaveExpert, and sampling scopes.
Hist minimum	Value of the lowest (left-most) populated bin in a histogram.		Available with DDM2, JTA2, XMATH, XWAV, CAN02, SDA, and XMAP options. Standard in DDA-5005A, SDA100G, and WaveExpert scopes.
Hist Mode	Position of the highest histogram peak.		Available with DDM2, JTA2, XMATH, XWAV, CAN02, SDA, and XMAP options. Standard in DDA-5005A, SDA100G, WaveExpert, and sampling scopes.
Hist Pop@X	Population at bin for specified horizontal coordinate. You can place the cursor at any bin and use either Absolute, Reference, or Difference cursor shape.		Available with DDM2, JTA2, SDM, XMATH, XWAV, CAN02, SDA, and XMAP options. Standard in DDA-5005A, SDA100G, and sampling scopes.
Hist Range	Calculates range (max - min) of a histogram.		Available with DDM2, JTA2, ENET, XMATH, XWAV, CAN02, SDA, and XMAP options. Standard in DDA-5005A, SDA100G, WaveExpert, and sampling scopes.

Hist rms	Root mean square of the values in a histogram.		Available with DDM2, JTA2, XMATH, XWAV, CAN02, SDA, and XMAP options. Standard in DDA-5005A, SDA100G, and sampling scopes
Hist sdev	Standard deviation of values in a histogram.		Available with DDM2, JTA2, XMATH, XWAV, CAN02, SDA, and XMAP options. Standard in DDA-5005A, SDA100G, WaveExpert, and sampling scopes.
Hist top	Value of the right-most of the two most populated histogram peaks.		Available with DDM2, JTA2, XMATH, XWAV, CAN02, SDA, and XMAP options. Standard in DDA-5005A, SDA100G, WaveExpert, and sampling scopes.
Hist X@peak	The value of the nth highest histogram peak.		Applies only to histograms. Available with JTA2, XMATH, XWAV, CAN02, DDM2, SDA, and XMAP options. Standard in DDA-5005A, SDA100G, and WaveExpert scopes.
Hold time	Time from the clock edge to the data edge. You can set levels, slope, and hysteresis independently for Hold Clock and Hold Data. See also Setup parameter.		Reference levels and edge-transition polarity can be selected. Hysteresis argument used to discriminate levels from noise in data. Available with JTA2, ENET, USB2, SDA, and XMAP options. Standard in SDA100G scopes.

Hparam Script	Visual Basic (or Java) script which produces a measurement from one or two input histogram results		Available with XMAP, ASDA, and XDEV options. Standard in DDA-5005A.
Jitter Filter	Jitter in the specified frequency band. Generates a time sequence of jitter measurements that are filtered by the selected band-pass filter.		Available with ASDA option.
Last	Time from trigger to last (rightmost) cursor.	Time from trigger to last cursor	Indicates location of right cursor. Cursors are interchangeable: for example, the right cursor may be moved to the left of the left cursor and first will give the location of the cursor formerly on the left, now on right. Standard parameter.
Level@X	Gives the vertical value at the specified x position. If the x position is between two points, it gives the interpolated value. When the Nearest point checkbox is checked, it gives the vertical value of the nearest data point.		Standard parameter.
Local base	Value of the baseline for a local feature.		Hysteresis argument used to discriminate levels from noise in data. Available with DDM2 option. Standard in DDA-5005A.
Local bsep	Local baseline separation, between rising and falling slopes.		Hysteresis argument used to discriminate levels from noise in data. Available with DDM2 option. Standard in DDA-5005A.

Local max	Maximum value of a local feature.		Hysteresis argument used to discriminate levels from noise in data. Available with DDM2 option. Standard in DDA-5005A.
Local min	Minimum value of a local feature.		Hysteresis argument used to discriminate levels from noise in data. Available with DDM2 option. Standard in DDA-5005A.
Local number	Number of local features (peak/trough pairs).		Hysteresis argument used to discriminate levels from noise in data. Available with DDM2 option. Standard in DDA-5005A.
Local pkpk	Vertical difference between the peak and trough of a local feature ($I_{max} - I_{min}$).		Hysteresis argument used to discriminate levels from noise in data. Available with DDM2 option. Standard in DDA-5005A.
Local tbe	Time between events (between local peak and next trough or local trough and next peak).		Hysteresis argument used to discriminate levels from noise in data. Available with DDM2 option. Standard in DDA-5005A.

Local tbp	Time between a local feature peak and the next local peak.		Hysteresis argument used to discriminate levels from noise in data. Available with DDM2 option. Standard in DDA-5005A.
Local tbt	Time between a local feature trough and the next local trough.		Hysteresis argument used to discriminate levels from noise in data. Available with DDM2 option. Standard in DDA-5005A.
Local tmax	Time of the maximum value of a local feature.		Hysteresis argument used to discriminate levels from noise in data. Available with DDM2 option. Standard in DDA-5005A.
Local tmin	Time of the minimum value of a local feature.		Hysteresis argument used to discriminate levels from noise in data. Available with DDM2 option. Standard in DDA-5005A.
Local tot	Time a local feature spends over a user specified percentage of its peak-to-trough amplitude.		Hysteresis argument used to discriminate levels from noise in data. Available with DDM2 option. Standard in DDA-5005A.

Local tpt	Time between local feature peak and trough.		Hysteresis argument used to discriminate levels from noise in data. Available with DDM2 option. Standard in DDA-5005A.
Local ttp	Time between local feature trough and the next local peak.		Hysteresis argument used to discriminate levels from noise in data. Available with DDM2 option. Standard in DDA-5005A.
Local tut	Time a local feature spends under a user specified percentage of its peak-to-trough amplitude.		Hysteresis argument used to discriminate levels from noise in data. Available with DDM2 option. Standard in DDA-5005A.
Mathcad	Produces a parameter using a user-specified Mathcad function.		Available with XMAP and XDEV option. Standard in DDA-5005A. Mathcad 2001i or later must be loaded on the instrument.
MATLAB	Produces a parameter using a user-specified MATLAB function.		Available with XMAP and XDEV option. Standard in DDA-5005A, WaveRunner 6000A, WaveMaster, WavePro 7000A, and sampling scopes MATLAB must be loaded on the instrument.

Maximum	Measures highest point in waveform. Unlike top, does not assume waveform has two levels.	Highest value in waveform between cursors	Gives similar result when applied to time domain waveform or histogram of data of same waveform. But with histograms, result may include contributions from more than one acquisition. Computes horizontal axis location of rightmost non-zero bin of histogram -- not to be confused with maxp. Standard parameter.
Mean	Average of data for time domain waveform. Computed as centroid of distribution for a histogram.	Average of data	Gives similar result when applied to time domain waveform or histogram of data of same waveform. But with histograms, result may include contributions from more than one acquisition. Standard parameter.
Median	The average of base and top values.	Average of Base and Top.	Standard parameter.
Minimum	Measures the lowest point in a waveform. Unlike base, does not assume waveform has two levels.	Lowest value in waveform between cursors	Gives similar result when applied to time domain waveform or histogram of data of same waveform. But with histograms, result may include contributions from more than one acquisition. Standard parameter.
Nb phase	Provides a measurement of the phase at a specific frequency of a waveform (narrow band).		Available with DDM2, XMATH, SDA, and XMAP options. Standard in DDA-5005A and SDA100G scopes.

Nb Power	Provides a measurement of the power at a specific frequency of a waveform (narrow band).		Available with DDM2, XMATH, PMA2, SDA, and XMAP options. Standard in DDA-5005A and SDA100G scopes.
N-cycle jitter	Peak-to-peak jitter between edges spaced n UI apart.	Compares the expected time to the actual time of leading edges n bits apart.	Available in SDA analyzers.
NLTS	Provides a measurement of the nonlinear transition shift for a prml signal.		Available with DDM2 option. Standard in DDA-5005AA.
Num Points	Number of points in the waveform between the cursors.		Standard parameter.
One Level	One level of an eye diagram		Available with SDA and SDM options. Standard in SDA, SDA100G, and WaveExpert scopes.
Overshoot-	Overshoot negative: Amount of overshoot following a falling edge, as percentage of amplitude.	$(\text{base} - \text{min.})/\text{ampl} \times 100$	Waveform must contain at least one falling edge. On signals not having two major levels (triangle or saw-tooth waves, for example), may not give predictable results. Standard parameter.
Overshoot+	Overshoot positive: Amount of overshoot following a rising edge specified as percentage of amplitude.	$(\text{max.} - \text{top})/\text{ampl} \times 100$	Waveform must contain at least one rising edge. On signals not having two major levels (triangle or saw-tooth waves, for example), may not give predictable results. Standard parameter.
Overwrite	Ratio of residual-to-original power of a low frequency waveform overwritten by a higher frequency.		Available with DDM2 option. Standard in DDA-5005A.

Param Script	Visual Basic or Java script that produces a measurement from one or two input waveforms.		Available with XMAP, XDEV, and ASDA options. Standard in DDA-5005A.
Peak Mag	Peak mag away from a baseline. Note: the measure gate must include more of the baseline than any other single level.		Available with ENET option.
Peaks	Number of peaks in a histogram.		Available with DDM2, JTA2, XMATH, XWAV, CAN02, SDA, and XMAP options. Standard in DDA-5005A, SDA100G, and WaveExpert scopes.
Peak to peak	Peak-to-peak: Difference between highest and lowest points in waveform. Unlike ampl, does not assume the waveform has two levels.	maximum - minimum	Gives a similar result when applied to time domain waveform or histogram of data of the same waveform. But with histograms, result may include contributions from more than one acquisition. Standard parameter.
Percentile	Horizontal data value that divides a histogram so the population to the left is xx% of the total.		Available with DDM2, JTA2, XMATH, XWAV, CAN02, SDA, and XMAP options. Standard in DDA-5005A, SDA100G, WaveExpert, and sampling scopes.
Per DCD	Amount of jitter due to duty cycle distortion		Standard in SDA and WaveExpert scopes.
Per Duty Cyc	Duty cycle measured on a persistence		Standard in SDA and WaveExpert scopes.

Period	Period of a cyclic signal measured as time between every other pair of 50% crossings. Starting with first transition after left cursor, period is measured for each transition pair, with values averaged to give final result.	$\frac{1}{M_r} \sum_{i=1}^{M_r} (T_{r_i}^{50} - T_{f_i}^{50})$ <p>Where: M_r is the number of leading edges found, M_f the number of trailing edges found, $T_{r_i}^{x\%}$ the time when rising edge i crosses the $x\%$ level, and $T_{f_i}^{x\%}$ the time when falling edge i crosses the $x\%$ level.</p>	Standard parameter.
Period@level	Period at a specified level and slope for every cycle in waveform.		Reference levels and edge-transition polarity can be selected. Hysteresis argument used to discriminate levels from noise in data. Available with JTA2, AORM, ENET, SDA, and XMAP options. Standard in DDA-5005A, SDA100G, and WavePro 7000A scopes.
Per Pulse Sym	Symmetry of RZ pulse around eye aperture center		Standard in SDA and WaveExpert scopes.
Persist Area	Area under mean persistence trace		Standard in SDA and WaveExpert scopes.
Persist Max	Highest vertical value of input persistence		Standard in SDA and WaveExpert scopes.
Persist Mean	Average of persistence data		Standard in SDA and WaveExpert scopes.
Persist Mid	Mid level between Maximum and Minimum data		Standard in SDA and WaveExpert scopes.
Persist Min	Lowest vertical value of input persistence		Standard in SDA and WaveExpert scopes.
Persist PkPk	Difference between maximum and minimum data values		Standard in SDA and WaveExpert scopes.
Persist RMS	Root mean square of persistence data		Standard in SDA and WaveExpert scopes.

Phase	Phase difference between signal analyzed and signal used as reference. You can set the output type to percent, degrees, or radians. After setting up the reference, touch the More tab for signal setups.	Phase difference between signal and reference	Standard parameter.
Pj	Periodic component of jitter		Available with SDA option.
Power Factor	Ratio of real to apparent power		Available with PMA2 option.
PW50	Average pulse width at the 50% point between the local baseline and the local peak or trough.		Hysteresis argument used to discriminate levels from noise in data. Available with DDM2 option. Standard in DDA-5005A.
PW50-	Average pulse width at the 50% point between the local baseline and the local trough.		Hysteresis argument used to discriminate levels from noise in data. Available with DDM2 option. Standard in DDA-5005A.
PW50+	Average pulse width at the 50% point between the local baseline and the local peak.		Hysteresis argument used to discriminate levels from noise in data. Available with DDM2 option. Standard in DDA-5005A.
Real Power	Mean of the product of voltage and current waveform (or mean of the instantaneous power)		Available with PMA2 option.

Resolution	Ratio of taa for a high and low frequency waveform	taa (HF)/mean taa (LF)*100	Hysteresis argument used to discriminate levels from noise in data. Available in DDM2. Standard in DDA-5005A.															
Ring	Ringback (high or low)		Available with SDA parameter.															
Rj Effective	Amount of random jitter (estimated) in a signal		Available with SDA parameter.															
Rise	Rise time: Duration of rising edge from 10-90%.	Time at lower threshold minus	On signals not having two major levels (triangle or saw-tooth waves, for example), top and base can default to maximum and minimum, giving, however, less predictable results. Standard parameter.															
	<table border="1" style="width: 100%; border-collapse: collapse;"> <thead> <tr> <th>Thresh.</th> <th>Remote</th> <th>Lower Limit</th> <th>Upper Limit</th> <th>Default</th> </tr> </thead> <tbody> <tr> <td>Lower</td> <td>Low</td> <td>1 %</td> <td>45 %</td> <td>10 %</td> </tr> <tr> <td>Upper</td> <td>High</td> <td>55 %</td> <td>99 %</td> <td>90 %</td> </tr> </tbody> </table>	Thresh.		Remote	Lower Limit	Upper Limit	Default	Lower	Low	1 %	45 %	10 %	Upper	High	55 %	99 %	90 %	Time at upper threshold
	Thresh.	Remote		Lower Limit	Upper Limit	Default												
	Lower	Low		1 %	45 %	10 %												
Upper	High	55 %	99 %	90 %														
	Threshold arguments specify two vertical values on each edge used to compute rise time.	averaged over each rising edge																
	Formulas for upper and lower values: $lower = lower\ thresh. \times amp/100 + base$ $upper = upper\ thresh. \times amp/100 + base$																	
Rise 20-80%	Rise 20% to 80%: Duration of pulse waveform's rising transition from 20% to 80%, averaged for all rising transitions between the cursors.	Average duration of rising 20-80% transition	On signals not having two major levels (triangle or saw-tooth waves, for example), top and base can default to maximum and minimum, giving, however, less predictable results. Standard parameter.															
Rise@level	Rise at level: Duration of pulse waveform's rising edges between transition levels.	Slew rate for % or absolute levels of rising or falling edges. Enhanced version sets measurement calculations to use one of the following:	On signals not having two major levels (triangle or saw-tooth waves, for example), top and base can default to maximum and minimum, giving,															

		Base & Top (% or absolute) Peak-Peak (%) 0V-Max (%)	however, less predictable results. Standard parameter. Enhanced parameter available with EMC option.
RMS	Root Mean Square of data between the cursors -- about same as sdev for a zero-mean waveform.	$\sqrt{\frac{1}{N} \sum_{i=1}^N (v_i)^2}$ <p>Where: v_i denotes measured sample values, and N = number of data points within the periods found up to maximum of 100 periods.</p>	Gives similar result when applied to time domain waveform or histogram of data of same waveform. But with histograms, result may include contributions from more than one acquisition. Standard parameter.
SAS	Signal Amplitude Symmetry of a 100Base-T signal		Available with ENET option.
SD2Skew	Calculates the time skew between 2 serial data lanes		Available with SDA and PCIE options.
Setup	Time from the data edge to the clock edge.		Reference levels and edge-transition polarity can be selected. Hysteresis argument used to discriminate levels from noise in data. Available with JTA2 and XMAP options. Standard in SDA and SDA100G scopes.
Skew	Time of clock1 edge minus time of nearest clock2 edge.		Reference levels and edge-transition polarity can be selected. Hysteresis argument used to discriminate levels from noise in data. Hysteresis on a measurement (if set to 500 mdiv) requires that the signal must transition one way 1/2 division (total swing) across the threshold for the measurement to be

			valid. Available with JTA2 and XMAP options. Standard in SDA100G and WaveSurfer scopes.
Slew Rate	Slew rate or local dV/dt in a transition zone		Available in SDA and JTA2 options. Standard in SDA100G scopes.
SSC Diff	Calculates difference between average SSC frequencies.		Available with PCIE option.
SSC Frequency	Frequency of Spread Spectrum Clock signal.		Available with PCIE option.
SSC Ratio	Calculates the ratio between the maximum and minimum SSC frequencies.		Available with PCIE option.
SSC Track	Tracks Spread Spectrum Clock. Filtered track of frequency at level.		Available with ASDA option.
Std dev	Standard deviation of the data between the cursors -- about the same as rms for a zero-mean waveform.	$\sqrt{\frac{1}{N} \sum_{i=1}^N (v_i - mean)^2}$	<p>Gives similar result when applied to time domain waveform or histogram of data of same waveform. But with histograms, result may include contributions from more than one acquisition.</p> <p>Where: v_i denotes measured sample values, and N = number of data points within the periods found up to maximum of 100 periods.</p> <p>Standard parameter.</p>
TAA	Average peak-to-trough amplitude for all local features.		<p>Hysteresis argument used to discriminate levels from noise in data.</p> <p>Available with DDM2 option.</p> <p>Standard in</p>

			DDA-5005A.
TAA-	Average local baseline-to-trough amplitude for all local features.		Hysteresis argument used to discriminate levels from noise in data. Available with DDM2 option. Standard in DDA-5005A.
TAA+	Average local baseline-to-peak amplitude for all local features.		Hysteresis argument used to discriminate levels from noise in data. Available with DDM2 option. Standard in DDA-5005A.
TIE@level	Difference between the measured times of crossing a given slope and level and the ideal expected time. For Slope you can choose positive, negative, or both. For output units you can choose time or unit interval (UI). A unit interval equals one clock period. The Virtual Clock setup gives you a choice of Standard (1.544 MHz) or Custom reference clocks. You can also use a mathematically derived Golden PLL to filter low frequency jitter. The cutoff frequency is user selectable.	Cutoff Freq = $(1/1.667e3) \times$ Clock Freq	Reference levels and edge-transition polarity can be selected. Hysteresis argument used to discriminate levels from noise in data. Available with JTA2, ENET, SDA, and XMAP options. Standard in SDA100G, WavePro 7000A, WaveExpert, and sampling scopes.
Time@edge	Measures time at each edge on each digital line		Available with MS-32 option.
Time@level	Time at level: Time from trigger (t=0) to crossing at a specified level.	Time from trigger to crossing level	Reference levels and edge-transition polarity can be selected. Hysteresis argument used to discriminate levels from noise in data. Standard parameter.
Top	Higher of two most probable states, the lower being base; it is	Value of most probable higher state	Gives similar result when applied to time

	characteristic of rectangular waveforms and represents the higher most probable state determined from the statistical distribution of data point values in the waveform.		domain waveform or histogram of data of same waveform. But with histograms, result may include contributions from more than one acquisition. Standard parameter.
Total Jitter	Total jitter at a given bit error rate		Available with ENET and SDA options.
Total Pop	Total population of a histogram.		Available with DDM2, JTA2, XMATH, XWAV, CAN02, SDA, and XMAP options. Standard in DDA-5005A, SDA100G, WaveExpert, and sampling scopes
tUpS	Upsamples a time parameter by nX		Available with SDA and SDM options.
TxCmD	PCI Express: V TX-CM-DC-LINE-DELTA Absolute delta of DC common mode voltage between D+ and D-		Available with PCIE option.
TxFall	Fall2080 and ParamRescale, to get UI		Available with PCIE option.
TxRise	Rise2080 and ParamRescale, to get UI		Available with PCIE option.
Vcross	Voltage at which two signals cross. That is, voltage of either signal at the time when difference is zero.		Available with SDA and PCIE options.
Vdiff	Used for V TX-DIFFp-p and V RX-DIFFp-p for PCI-Express		Available with PCIE option.
VTxDeRatio	Ratio between transition and de-emphasized bits		Available with PCIE option.
Width	Width of cyclic signal determined by examining 50% crossings in data input. If first transition after left cursor is a rising edge, waveform is considered to consist of positive pulses and width the time between adjacent rising and falling edges. Conversely, if falling edge, pulses are considered negative and width	Width of first positive or negative pulse averaged for all similar pulses	Similar to fwhm, though, unlike width, that parameter applies only to histograms. Standard parameter.

	the time between adjacent falling and rising edges. For both cases, widths of all waveform pulses are averaged for the final result.		
Width@level	Width measured at a specific level.	Time between two transitions of opposite slope at a specified level. (Slope specified for 1st transition.) Enhanced version sets measurement calculations to use one of the following: Base & Top (% or absolute) Peak-Peak (%) 0V-Max (%) 0V-Min (%)	Reference levels and edge-transition polarity can be selected. Hysteresis argument used to discriminate levels from noise in data. Available with JTA2, USB2, EMC, SDA, and XMAP options. Standard in SDA100G and WavePro 7000A scopes. Enhanced parameter available with EMC option.
WidthN	Width measured at the 50% level and negative slope.		Standard parameter.
X@max	Determines the horizontal axis location of the maximum value between the cursors.		Restricted to time and frequency waveforms only.
X@min	Determines the horizontal axis location of the minimum value between the cursors.		Restricted to time and frequency waveforms only.
Zero Level	Zero level of an eye diagram		Available with SDA and SDM options. Standard in SDA, SDA100G, and WaveExpert scopes.

Qualified Parameters

Some LeCroy instruments and software packages give you the capability to constrain parameter measurements to a vertically or horizontally limited range, or to occurrences gated by a second waveform. Furthermore, both constraints can operate together. This capability enables you to exclude unwanted characteristics from your measurements. It is much more restrictive than Measure Gate, which is used only to narrow the span of the waveform for analysis, along the horizontal axis.

Range Limited Parameters

To Set Up Range Qualifiers

1. From the menu bar, select **Measure**, then **Measure Setup...** from the drop-down menu.
2. Touch a **Px** tab to open the setup dialog.
3. Touch inside the **Source** field and select a source from the pop-up menu.
4. Touch inside the **Measure** field and select a parameter from the pop-up menu.
5. Touch the **Accept** tab of the right-hand dialog, then touch the **Values In Range** checkbox. Depending on whether you select a vertical or horizontal parameter, the correct units will be automatically displayed (V, s, Hz, dB) in the **Between** and **And** fields. Or, if you select a simple ratio parameter (such as power factor) which yields a dimensionless number, no units will be displayed.
6. Touch the **Find Range** button to quickly display the most recent value of the parameter measurement. From there it is a simple matter to set the desired range.

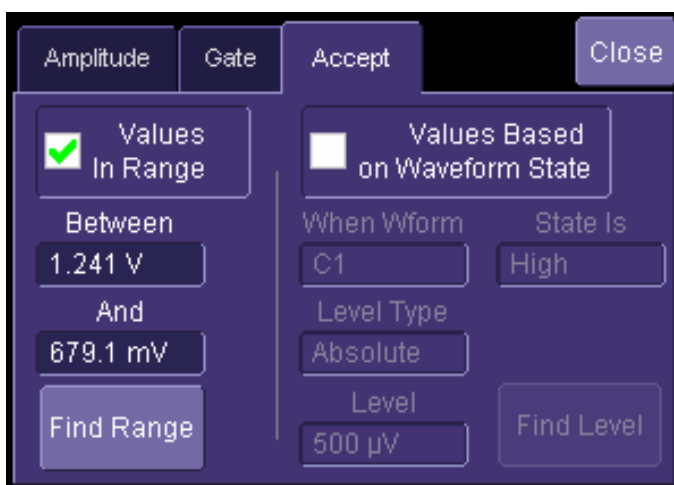

**Amplitude Parameter
(range set manually)**

Delay Gate Accept Close

Values In Range

Between
-14.83 μ s

And
-14.83 μ s

Find Range

Values Based on Waveform State

When Wform C1 State Is High

Level Type Absolute

Level 777.3 mV Find Level

Delay Parameter
(Find Range selected)

Waveform Gated Parameters

To Set Up Waveform Qualifiers

1. From the menu bar, select **Measure**, then **Measure Setup...** from the drop-down menu.
2. Touch a **Px** tab to open the setup dialog.
3. Touch inside the **Source** field and select a source from the pop-up menu.
4. Touch inside the **Measure** field and select a parameter from the pop-up menu.
5. Touch the **Accept** tab of the right-hand dialog, then touch the **Values Based on Waveform State** checkbox.
6. Touch inside the **When Wform** field and select the gating source.
7. Touch inside the **State Is** field and select **High** or **Low** from the pop-up menu. Parameter measurements on the subject waveform will only be taken when the gating waveform is in the selected state.
8. Touch inside the **Level Type** field and select **Absolute** or **Percent** from the pop-up menu.
9. Touch inside the **Level** field and enter the crossing level value at which you want measurements to begin. Alternatively, touch the **Find Level** button to automatically select the 50% level of your gating waveform:

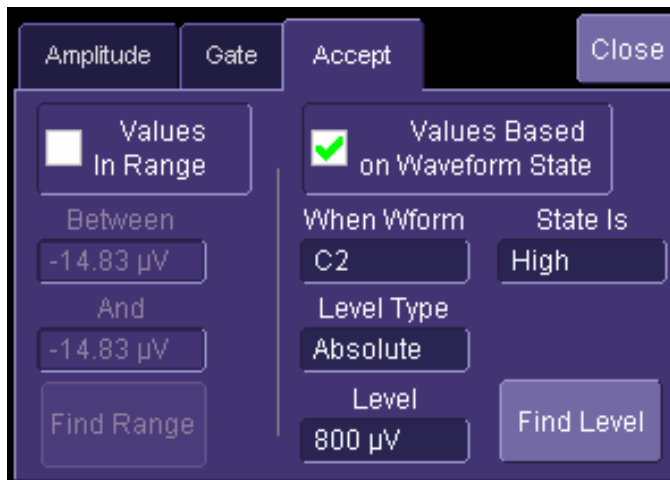

WAVEFORM MATH

Introduction to Math Traces and Functions

With the instrument's math tools you can perform mathematical functions on a waveform displayed on any channel, or recalled from any of the four reference memories M1 to M4. You can also set up traces F1 to Fx [The number of math functions that can be performed at the same time depends on the software options loaded on your scope.] to do math on parameter measurements P1 to Px [The number of parameters that can be measured at the same time depends on the software options loaded on your scope.].

For example: you could set up Trace F1 as the difference between Channels 1 and 2, Trace F2 as the average of F1, and Trace F3 as the integral of F2. You could then display the integral of the averaged difference between Channels 1 and 2. Any trace and function can be chained to another trace and function. For example, you could make Trace F1 an average of Channel 1, Trace F2 an FFT of F1, and Trace F3 a zoom of F2.

Note: Math traces F5-F8 are available only if you have loaded software option package XMATH or XMAP on WaveMaster or WavePro scopes, but are standard on Disk Drive Analyzers and Serial Data Analyzers.

Math Made Easy

With the instrument's math tools you can perform mathematical functions on a waveform displayed on any channel C1 to C4, or recalled from any of the four reference memories M1 to M4. To do computations in sequence, you can also use math functions F1 to Fx as a source input waveform. Or you can use Parameters P1 through Px

For example: you could set up F1 as the difference between Channels 1 and 2, F2 as the average of F1, and F3 as the integral of F2. You could then display the integral of the averaged difference between Channels 1 and 2. Any trace and function can be chained to another trace and function. For example, you could make F1 an average of Channel 1, F2 an FFT of F1, and F3 a zoom of F2.

Refer to the Specifications to find out which math tools are available in each optional package.

To Set Up a Math Function

Math Setup

This setup mode allows you to quickly apply frequently used math functions.



1. In the menu bar, touch **Math**, then **Math setup...**
2. If there are math functions already assigned to **F1** through **Fx** [The number of math traces available depends on the software options loaded on your scope. See specifications.], touch the checkbox for the function you want to enable.
3. To assign a new math function to a trace, touch the Fx button for that trace, for example



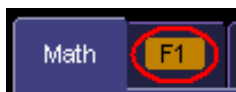

-
-
-
4. The math function menu appears.
4. Touch a menu selection; your new function is automatically assigned, with the same setups as were in place for the last function in that Fx position.
5. If you want to change other setup items, like the source waveform, touch the appropriate



Fx tab, for example . The setup dialog for that Fx position appears.

6. Touch the **Single** function button  if you want to perform just one math function on the trace, or touch the **Dual** function button  to perform math on math.
7. Touch the **Graph** button, then touch inside the **Graph with** field to select a graph mode. The Graph modes are as follows:

	Histogram of the values of a parameter
	Track of the values of a parameter
	Trend of the values of a parameter

Resampling To Deskew

Deskew whenever you need to compensate for different lengths of cables, probes, or anything else that might cause timing mismatches between signals. Resample a signal on one channel and adjust it in time relative to a signal on another channel.

To Resample

1. In the menu bar, touch **Math**, then **Math Setup...** in the drop-down menu.
2. Touch a math function trace tab **F1** through **Fx**. The number of math traces available depends on the software options loaded on your scope. See Specifications..
3. Touch the **single** function button.
4. Touch inside the **Source1** field and select a source: channel, math trace, memory location.
5. Touch inside the **Operator1** field and select **Deskew** from the **Functions** category.
6. In the dialog on the right, touch the **Deskew** tab.
7. Touch inside the **Delay by** data entry field and type in a time value, using the pop-up keypad.

Rescaling and Assigning Units

This feature allows you to apply a multiplication factor (a) and additive constant (b) to your waveform: $aX + b$. You can do it in the unit of your choice, depending on the type of application.

To Set Up Rescaling

1. In the menu bar, touch **Math**, then **Math Setup...** in the drop-down menu.
2. Touch a math function trace tab **F1** through **Fx**. The number of math traces available depends on the software options loaded on your scope. See Specifications..
3. Touch the **single** function button.
4. Touch inside the **Source1** data entry field and select a source: channel, math trace, memory location.
5. Touch inside the **Operator1** data entry field and select **Rescale** from the **Functions** category.
6. In the dialog on the right, touch the **Rescale** tab.
7. Touch inside the **First multiply by** checkbox and enter a value for a , the multiplication factor.
8. Touch inside the **then add:** data entry field and enter a value for b , the additive constant.
9. Touch inside the **Override units** checkbox to disregard the source waveform's units, using the pop-up keyboard.

Averaging Waveforms

Summed vs. Continuous Averaging

For Summed averaging, you specify the number of acquisitions to be averaged. The averaged data is updated at regular intervals and presented on the screen.

On the other hand, Continuous averaging (the system default) helps to eliminate the effects of noise by continuously acquiring new data and adding the new waveforms into the averaging buffer. You determine the importance of new data vs. old data by assigning a weighting factor. Continuous averaging allows you to make adjustments to a system under test and to see the results immediately.

Note: Continuous Averaging is accessible from the channel "Vertical Adjust" dialog under "Pre-Processing," and from the math function menu.

Summed Averaging

Summed Averaging is the repeated addition, with equal weight, of successive source waveform records. If a stable trigger is available, the resulting average has a random noise component lower than that of a single-shot record. Whenever the maximum number of sweeps is reached, the averaging process stops.

An even larger number of records can be accumulated simply by changing the number in the dialog. However, the other parameters must be left unchanged or a new averaging calculation will be started. You can pause the averaging by changing the trigger mode from NORM/AUTO to STOP.

The instrument resumes averaging when you change the trigger mode back to NORM/AUTO.

You can reset the accumulated average by pushing the CLEAR SWEEPS button or by changing an acquisition parameter such as input gain, offset, coupling, trigger condition, timebase, or bandwidth limit. The number of current averaged waveforms of the function, or its zoom, is shown in the acquisition status dialog. When summed averaging is performed, the display is updated at a reduced rate to increase the averaging speed (points and events per second).

Continuous Averaging

Continuous Averaging, the default setting, is the repeated addition, with unequal weight, of successive source waveforms. It is particularly useful for reducing noise on signals that drift very slowly in time or amplitude. The most recently acquired waveform has more weight than all the previously acquired ones: the continuous average is dominated by the statistical fluctuations of the most recently acquired waveform. The weight of 'old' waveforms in the continuous average gradually tends to zero (following an exponential rule) at a rate that decreases as the weight increases.

The formula for continuous averaging is

$$\text{new average} = (\text{new data} + \text{weight} * \text{old average}) / (\text{weight} + 1)$$

This is also the formula used to compute summed averaging. But by setting a "sweeps" value, you establish a fixed weight that is assigned to the old average once the number of "sweeps" is reached. For example, for a sweeps (weight) value of 4:

1st sweep (no old average yet): new average = (new data + 0 * old average) / (0 + 1) = new data only

2nd sweep: new average = (new data + 1 * old average) / (1 + 1) = 1/2 new data + 1/2 old average

3rd sweep: new average = (new data + 2 * old average) / (2 + 1) = 1/3 new data + 2/3 old average

4th sweep: new average = (new data + 3 * old average) / (3 + 1) = 1/4 new data + 3/4 old average

5th sweep: new average = (new data + 4 * old average) / (4 + 1) = 1/5 new data + 4/5 old average

6th sweep: new average = (new data + 4 * old average) / (4 + 1) = 1/5 new data + 4/5 old average

7th sweep: new average = (new data + 4 * old average) / (4 + 1) = 1/5 new data + 4/5 old average

In this way, for sweeps > 4 the importance of the old average begins to decrease exponentially.

Note: The number of sweeps used to compute the average will be displayed in the bottom line of the trace descriptor label:

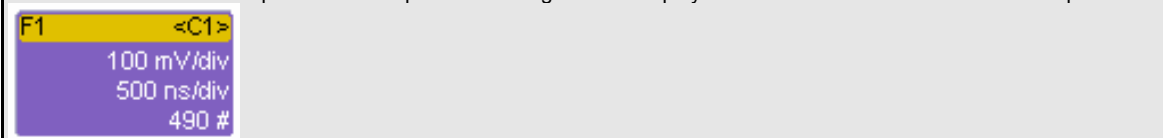

To Set Up Continuous Averaging

1. In the menu bar, touch **Math**, then **Math Setup...** in the drop-down menu.
2. Select a function tab from **F1** through **Fx** [The number of math traces available depends on the software options loaded on your scope. See Specifications.].
3. Touch inside the **Source1** field and select a source waveform from the pop-up menu.
4. Touch inside the **Operator1** field and select **Average** from the **Select Math Operator** menu.
5. Touch the **Average** tab in the dialog to the right of the "Fx" dialog, touch the **Continuous** button.
6. Touch inside the **Sweeps** data entry field and enter a value using the pop-up keypad. The valid range is 1 to 1,000,000 sweeps.

To Set Up Summed Averaging

1. In the menu bar, touch **Math**, then **Math Setup...** in the drop-down menu.
2. Select a function tab from **F1** through **Fx** [The number of math traces available depends on the software options loaded on your scope. See Specifications.].
3. Touch inside the **Source1** field and select a source waveform from the pop-up menu.
4. Touch inside the **Operator1** field and select **Average** from the **Select Math Operator** menu.
5. Touch the **Average** tab in the dialog to the right of the "Fx" dialog, then touch the **Summed** button.
6. Touch inside the **Sweeps** data entry field and type in a value using the pop-up keypad. The valid range is 1 to 1,000,000 sweeps.

Enhanced Resolution

ERES (Enhanced Resolution) filtering increases vertical resolution, allowing you to distinguish closely spaced voltage levels. The functioning of the instrument's ERES is similar to smoothing the signal with a simple, moving-average filter. However, it is more efficient concerning bandwidth and pass-band filtering. Use ERES on single-shot waveforms, or where the data record is slowly repetitive (when you cannot use averaging). Use it to reduce noise when your signal is noticeably noisy, but you do not need to perform noise measurements. Also use it when you perform high-precision voltage measurements: zooming with high vertical gain, for example.

How the Instrument Enhances Resolution

The instrument's enhanced resolution feature improves vertical resolution by a fixed amount for each filter. This real increase in resolution occurs whether or not the signal is noisy, or your signal is single-shot or repetitive. The signal-to-noise ratio (SNR) improvement you gain is dependent on the form of the noise in the original signal. The enhanced resolution filtering decreases the bandwidth of the signal, filtering out some of the noise.

The instrument's constant phase FIR (Finite Impulse Response) filters provide fast computation,

excellent step response in 0.5 bit steps, and minimum bandwidth reduction for resolution improvements of between 0.5 and 3 bits. Each step corresponds to a bandwidth reduction factor of two, allowing easy control of the bandwidth resolution trade-off. The parameters of the six filters are given in the following table.

Resolution increased by	-3 dB Bandwidth (× Nyquist)	Filter Length (Samples)
0.5	0.5	2
1.0	0.241	5
1.5	0.121	10
2.0	0.058	24
2.5	0.029	51
3.0	0.016	117

With low-pass filters, the actual SNR increase obtained in any particular situation depends on the power spectral density of the noise on the signal.

The improvement in SNR corresponds to the improvement in resolution if the noise in the signal is white -- evenly distributed across the frequency spectrum.

If the noise power is biased towards high frequencies, the SNR improvement will be better than the resolution improvement.

The opposite may be true if the noise is mostly at lower frequencies. SNR improvement due to the removal of coherent noise signals -- feed-through of clock signals, for example -- is determined by the fall of the dominant frequency components of the signal in the passband. This is easily ascertained using spectral analysis. The filters have a precisely constant zero-phase response. This has two benefits. First, the filters do not distort the relative position of different events in the waveform, even if the events' frequency content is different. Second, because the waveforms are stored, the delay normally associated with filtering (between the input and output waveforms) can be exactly compensated during the computation of the filtered waveform.

The filters have been given exact unity gain at low frequency. Enhanced resolution should therefore not cause overflow if the source data is not overflowed. If part of the source trace were to overflow, filtering would be allowed, but the results in the vicinity of the overflowed data -- the filter impulse response length -- would be incorrect. This is because in some circumstances an overflow may be a spike of only one or two samples, and the energy in this spike may not be enough to significantly affect the results. It would then be undesirable to disallow the whole trace.

The following examples illustrate how you might use the instrument's enhanced resolution function.

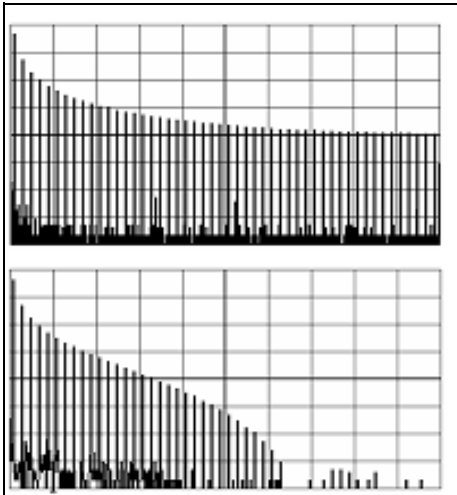
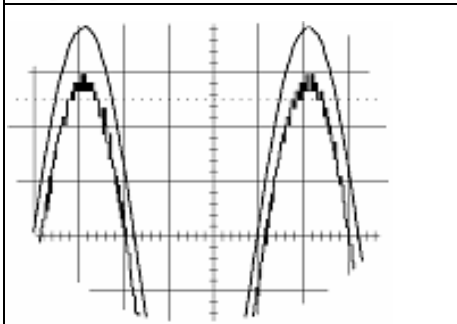
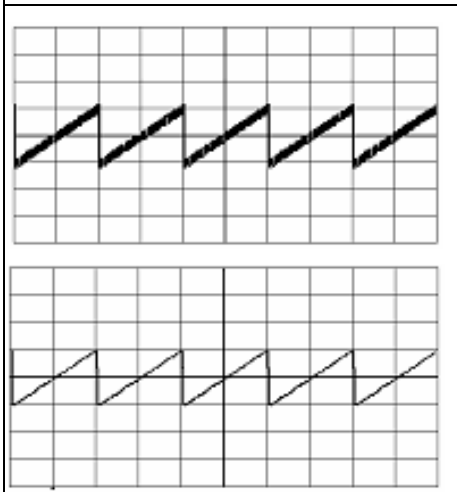
	<p>In low-pass filtering: The spectrum of a square signal before (left top) and after (left bottom) enhanced resolution processing. The result clearly illustrates how the filter rejects high-frequency components from the signal. The higher the bit enhancement, the lower the resulting bandwidth.</p>
	<p>To increase vertical resolution: In the example at left, the lower ("inner") trace has been significantly enhanced by a three-bit enhanced resolution function.</p>
	<p>To reduce noise: The example at left shows enhanced resolution of a noisy signal. The original trace (left top) has been processed by a 2-bit enhanced resolution filter. The result (left bottom) shows a "smooth" trace, where most of the noise has been eliminated.</p>

Note: Enhanced resolution can only improve the resolution of a trace; it cannot improve the accuracy or linearity of the original quantization. The pass-band will cause signal attenuation for signals near the cut-off frequency. The highest frequencies passed may be slightly attenuated. Perform the filtering on finite record lengths. Data will be lost at the start and end of the waveform: the trace will be slightly shorter after filtering. The number of samples lost is exactly equal to the length of the impulse response of the filter used: between 2 and 117 samples. Normally this loss (just 0.2 % of a 50,000 point trace) is not noticed. However, you might filter a record so short there would be no data output. In that case, however, the instrument would not allow you to use the ERES feature.

To Set Up Enhanced Resolution (ERES)

1. In the menu bar, touch **Math**, then **Math Setup...** in the drop-down menu.
2. Touch a function tab **F1** through **Fx**. (The number of math traces available depends on the software options loaded on your scope. See Specifications.)
3. Touch inside the **Operator1** data entry field.
4. Select **ERES** from the **All Functions** or **Filter** group of Math functions.
5. Touch the **Trace On** checkbox.
6. Touch the "ERES" tab in the right-hand dialog, then touch inside the **bits** field and make an "Enhance by" selection from the pop-up menu:



Waveform Copy



The **Copy** math function makes a copy of your present waveform in its unprocessed state. While processing may continue on the original waveform, the copy enables faster throughput in some cases by preserving the original data. That is, no calculations need to be undone on the copy before additional math can be calculated.

This benefit of faster throughput, however, comes at the expense of memory usage.

Waveform Sparser



The Sparse math function allows you to thin out an incoming waveform by skipping points at regular intervals, and by starting acquisition at a particular "offset" (point). The **Sparsing factor** specifies the number of sample points to reduce the input waveform by. A sparsing factor of 4, for example, tells the scope to retain only one out of every 4 samples. A **Sparsing offset** of 3, on

the other hand, tells the scope to begin on the third sample, then skip the number of samples specified by the sparsing factor (4). In this way, the sample rate is effectively reduced.

For the sparsing factor (interval), you can set a value from 1 to 1,000,000 points. For the sparsing offset you can set a value from 0 to 999,999.

Note: The maximum sparsing offset that can be entered for any sparsing factor equals Sparsing Factor - 1.

To Set Up Waveform Sparser

1. In the menu bar, touch **Math**, then **Math setup...** in the drop-down menu.
2. Touch the tab for the function (F1 to Fx The number of math traces available depends on the software options loaded on your scope. See specifications.) you want to assign the Sparse operation to.
3. Touch inside the **Source1** field and select an input waveform.
4. Touch inside the **Operator1** field and select **Sparse** from the **Select Math Operator** menu.
5. Touch inside the **Sparsing factor** field and enter a value, using the pop-up keypad.
6. Touch inside the **Sparsing offset** field and enter a value, using the pop-up keypad.

Interpolation

Linear interpolation, which inserts a straight line between sample points, is best used to reconstruct straight-edged signals such as square waves. (Sinx)/x interpolation, on the other hand, is suitable for reconstructing curved or irregular waveshapes, especially when the sampling rate is 3 to 5 times the system bandwidth. The instrument also gives you a choice of Cubic interpolation.

For each method, you can select a factor from 2 to 50 points by which to interpolate (upsample).

To Set Up Interpolation

1. In the menu bar, touch **Math**, then **Math setup...** in the drop-down menu.
2. Touch the tab for the function (F1 to Fx The number of math traces available depends on the software options loaded on your scope. See Specifications.) you want to assign the Interpolate operation to.
3. Touch inside the **Source1** field and select an input waveform.
4. Touch inside the **Operator1** field, then touch the **Filter** button in the **Select Math Operator** menu.
5. Select **Interpolate** from the Filter submenu.
6. Touch the "Interpolate" tab in the mini setup dialog to the right of the main dialog.
7. Touch inside the **Algorithm** field and select an interpolation type.
8. Touch inside the **Upsample by** Upsampling is the factor by which sampling is increased. field and enter a value, using the pop-up numeric keypad, if you want to enter a specific value. Otherwise, use the **Up/Down** buttons to increment the displayed value in a 1-2-5 sequence.

Fast Wave Port

FastWavePort is a processing function for the LeCroy X-Stream family of digital oscilloscopes that enables you to insert your own custom processing algorithm, written in the C/C++ language, into the scope's processing stream. FastWavePort maximizes data throughput from the acquisition system to your processing function. It also makes it simple to create these custom processing functions.

The technology that makes this system possible is the ability of two processes in a Windows system to share a region of memory. This enables the transfer of data at high-speed between the acquisition software and the custom processing function, which runs in a separate process from the scope application. A major benefit of FastWavePort is that your application may be implemented and, more importantly, debugged independently of the main application.

It is important to note that the transfer of the results of your processing function back into the X-Stream processing stream is optional. If performance is the primary goal, and display or further processing of the results within the scope software is not required, then this may be skipped.

Fast Wave Port Setup -- Initial

1. In the menu bar, touch **Math**, then **Math Setup...** in the drop-down menu.



2. Touch one of the Math function tabs,  for example.
3. Touch inside the "Source1" field, and select a signal source from the pop-up menu. The source can be a channel waveform, math or memory trace, or a parameter.

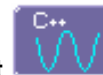

4. Touch inside the "Operator"1 field and select **FastWavePort** from the **Custom** menu

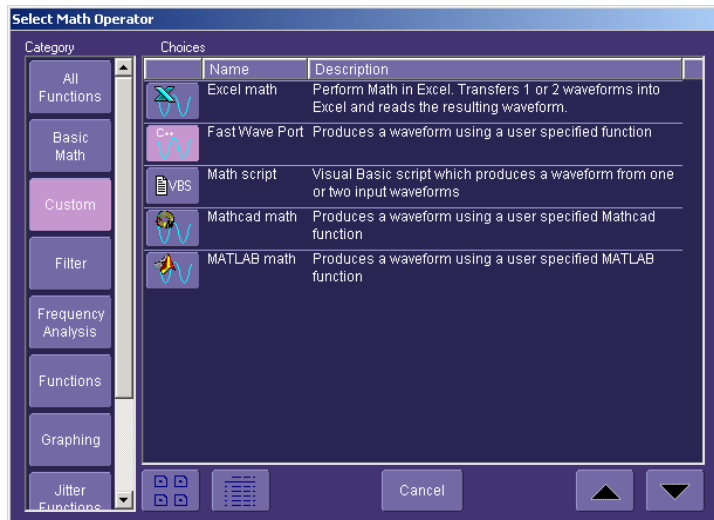

5. In the right-hand mini-dialog, touch the **Fast Wave Port** tab:

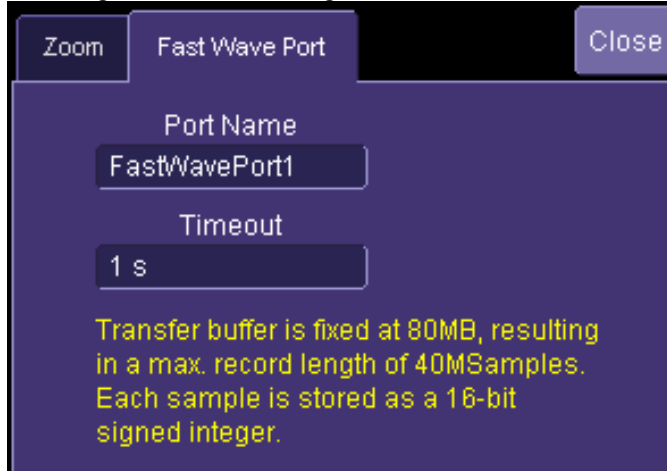

6. Touch inside the "Timeout" field and enter a suitable value.

Setup -- Case 1

This scenario assumes that you have developed your application on a PC.

1. Compile your application on your PC
2. Copy the compiled file onto the scope, using a memory stick or network drive.
3. Open the Command Prompt window (Start --> Programs --> Accessories --> Command Prompt) and run your application.

Setup -- Case 2

This scenario assumes that you have Visual C++ loaded on the scope.

- Use the Visual C++ editor to develop and run your application.

Setup -- Case 3

This scenario assumes that you are using a compiler other than Visual C++ (such as GNU's MinGW). It should be noted that the optimizer in the GNU C Compiler (GCC) is less efficient than that in Visual C++ and will result in lower performance.

1. Save your application in a text file, and copy it onto memory stick or network drive.
2. Using Windows Explorer, copy the text file to the scope.
3. Download and install the compiler onto the scope.
4. Configure Environmental Variables as follows:
 - A. Open Start --> Settings --> Control Panel --> System.
 - B. Click the "Advanced" tab, then the **Environmental Variables** button.
 - C. In the "System variables" window, click **Path**, then the **Edit** button.

D. At the end of the "Variable Value" string, append ;C:\MinGW\bin for the case of the GNU C Compiler (GCC) for example.

E. Click OK.

5. Open the Command Prompt window (Start --> Programs --> Accessories --> Command Prompt) and compile your application.
6. Run your application.

Operational Notes

Once FastWavePort is selected, the right-hand dialog shows the current settings. The first of these is critical, and indicates the base name of the memory window and the two events, which are global within the Windows O/S. This should be left at its default value and only changed if multiple FastWavePort functions are used in parallel. Note that this name must match the base name used in the client application.

The full names of these global objects are:

Memory Mapped File	"FastWavePort1File"
Data Available Event	"FastWavePort1MutexDataAvailable"
Processing Complete Event	"FastWavePort1MutexProcessingComplete"

The "Timeout" field specifies the amount of time that the scope will wait for the custom processing function to complete. This prevents the scope from waiting indefinitely for a potentially unforthcoming custom processing function. Be careful to set this value to something reasonable, which means a time that is longer by a reasonable margin than the custom processing is ever expected to take.

Example Applications

This simple C++ application may be used as a starting point for a custom processing function. It demonstrates the following:

- How to create handles to the global objects (the memory window and the two events)
- How to read data from the memory window when the scope flags that it's available
- How to scale the data into units of volts using data in the header that's stored at the beginning of the memory window.
- How to perform a simple processing function (in this case the absolute value)
- How to define the physical units of the output of the processing function (in this case 'Amps')
- How to flag to the scope application that processing is complete

```
//-----  
---  
// FastWavePortClient.cpp :  
//
```

```
// Prototype C++ client application for "Fast Wave Port" Math Processor
//
// Compatibility:
//     Microsoft Visual C++ 6.0, 7.1
//     MinGW 'gcc' based compiler (free download from http://www.mingw.org/)
//     Compile with: mingw32-c++ -o fastWavePortClient.exe fastwaveportclient.cpp
//-----
---

#include "windows.h"
#include <stdio.h>

//-----
// FastWavePort header, describes various properties of the waveform passed to the
// user-processing
// function. Also used to carry the properties of the processed waveform back to the
// DSO.

#define FLAGS_OUTPUT_VALID      0x01
typedef unsigned __int64 lecTimeStamp;
lecTimeStamp lecTimeStampOneSecond = 1000000000;          // 1 ns units in a second

#pragma pack(push, 4)          // pack on 4-byte boundaries (Important!)
struct CDescHeader
{
    int descVersion;          // header version number
    int flags;                // misc. flags indicating the status of input, and
                            // how to treat the output
    int headerSize;          // size of the header, data starts immediately after
                            // the hdr.
    int windowSize;          // total size of the window (header + data)
    int numSamples;          // total number of samples in the input waveform
    int segmentIndex;        // index of this segment, usually zero when input
                            // waveform is not a sequence

    int numSweeps;
    int _dummy1;             // not used

    double verGain;          // scale factor that relates integer sample data
                            // values to the vertical units of the waveform.
    double verOffset;        // vertical offset (in vertical units, e.g. Volts) of
                            // the waveform
    double verResolution;    // vertical resolution of the measurement system (also
                            // in vertical units)
    double horInterval;      // scale factor that relates integer sample indices to
                            // the horizontal units of the waveform.
};
```

```
double horOffset;           // horizontal offset (in horizontal units, e.g. seconds)
                             // of the waveform
double horResolution;       // horizontal resolution of the measurement system
                             //(also in horizontal units)
lecTimeStamp trigTime;     // trigger time, units of lns since 00:00:00 on Jan 1st
                             // 2000, 64-bit unsigned integer
char verUnit[48];          // vertical units of the waveform ("V" for example)
char horUnit[48];          // horizontal units of the waveform ("s" for example)
};
#pragma pack(pop)          // restore packing

//-----
---

// The buffer size is 80MB (40,000,000 samples, stored as short integers) plus 0x1000
// bytes for the header.
const unsigned long HEADER_SIZE = 0x1000
const unsigned long MEM_MAP_FILE_SIZE = 80000000 + HEADER_SIZE;    // = 40MSamples,
                                                                    // or 80MBytes

int main(int argc, char* argv[])
{
    // names based on 'FastWavePort1' name defined in Processor setup.
    char szMapFileName[]           = "FastWavePort1File";
    char szMutexDataAvailableName[] = "FastWavePort1MutexDataAvailable";
    char szMutexProcessingCompleteName[] = "FastWavePort1MutexProcessingComplete";

    // Associate shared memory file handle value.
    HANDLE m_hMMFile = CreateFileMapping ((HANDLE)0xffffffff, NULL, PAGE_READWRITE, 0,
MEM_MAP_FILE_SIZE, szMapFileName);
    if(m_hMMFile == 0)
    {
        printf("Unable to create file mapping\n");
        return 0;
    }

    // Map a view of this file for writing.
    short *m_lpMMFile = (short *)MapViewOfFile (m_hMMFile, FILE_MAP_ALL_ACCESS, 0, 0, 0);
    if(m_lpMMFile == 0)
    {
        printf("Unable to map view of file\n");
        return 0;
    }

    // create/open events used for synchronization
```

```
// if the client app. was run before the scope then these events will be created,
// if the scope was run first then these events
// will just be opened
HANDLE m_hDataAvailable = CreateEvent(NULL, FALSE, FALSE /* initial state */,
szMutexDataAvailableName);
HANDLE m_hProcessingComplete = CreateEvent(NULL, FALSE, FALSE /* initial state */,
szMutexProcessingCompleteName);
if(m_hDataAvailable == 0 || m_hProcessingComplete == 0)
{
    printf("Unable to open events\n");
    return 0;
}

// main loop
while(1)
{
    int i = 0;
    printf("Waiting for new data...\n");

    // wait an infinite amount of time for data to be available
    DWORD waitSuccess = WaitForSingleObject(m_hDataAvailable, INFINITE);

    // print the first few bytes of the input waveform
    CDescHeader *descHeader = (CDescHeader *) &m_lpMMFile[0];
    short *m_lpWaveform = &m_lpMMFile[descHeader->headerSize / sizeof(short)];
    for(i = 0; i < 4; ++i)
        printf("%f ", (m_lpWaveform[i] * descHeader->verGain) +
descHeader->verOffset);

    // compute the mean of all data values, while computing the abs value of the waveform
    //in-place
    double sum = 0.0;
    for(i = 0; i < descHeader->numSamples; ++i)
    {
        sum += (m_lpWaveform[i] * descHeader->verGain) + descHeader->verOffset;
        m_lpWaveform[i] = abs(m_lpWaveform[i]);
    }
    sum /= descHeader->numSamples;

    // modify the output units, set to Amps
    strcpy(descHeader->verUnit, "A");

    // print the mean, number of samples, trigger time in seconds, and the segment index
    printf("    (%f) %d %d %d\n", sum, descHeader->numSamples, (int)
(descHeader->trigTime / lecTimeStampOneSecond), descHeader->segmentIndex);
```



```
        // use to flag that the output is not valid, increasing performance when
        // it is not necessary to read data back into the DSO
        //descHeader->flags &= ~FLAGS_OUTPUT_VALID;

        // flag that processing is complete
        SetEvent(m_hProcessingComplete);
    }

    return 0;
}
```

Header Description

```
int descVersion;           // header version number
int flags;                 // misc. flags indicating the status of input, and how
                           // to treat the output
int headerSize;           // size of the header, data starts immediately after the
                           // hdr.
int windowSize;           // total size of the window (header + data)
int numSamples;           // total number of samples in the input waveform
int segmentIndex;         // index of this segment, usually zero when input waveform
                           // is not a sequence
int numSweeps;
int _dummy1;              // not used

double verGain;           // scale factor that relates integer sample data values
                           // to the vertical units of the waveform.
double verOffset;         // vertical offset (in vertical units, e.g. Volts) of the
                           // waveform
double verResolution;     // vertical resolution of the measurement system (also
                           // in vertical units)
double horInterval;       // scale factor that relates integer sample indices to
                           // the horizontal units of the waveform.
double horOffset;         // horizontal offset (in horizontal units, e.g. seconds)
                           // of the waveform
    double horResolution; // horizontal resolution of the measurement system
                           // (also in horizontal units)
    lecTimeStamp trigTime; // trigger time, units of lns since 00:00:00 on Jan
                           // 1st 2000, 64-bit unsigned integer
    char verUnit[48];     // vertical units of the waveform ("V" for example)
    char horUnit[48];     // horizontal units of the waveform ("s" for example)
```

Data Length Limitations

The size of the memory window is fixed at 80 Mbytes, which equates to 40M samples.

Performance

Under optimal conditions, on a scope with a 1.7 GHz Celeron processor, rates of up to 75 MS/s have been observed. Due to the differences between the acquisition and processing hardware in each of the X-Stream scopes, this value may vary significantly and therefore cannot be guaranteed. However, this is by far the fastest way to process data using a user-defined algorithm on an X-Stream scope.

Choice of Programming Language

The system was designed for use with the C/C++ programming language, and all furnished examples use this language. It is theoretically possible, however, for the processing to be implemented in any language that supports Windows named events (Mutex) and can open a named memory-mapped file. Nevertheless, no guarantee can be given as to the behavior of the system using anything but C/C++.

Demodulation

The DMOD math function adds seven new processing functions:

- **Amplitude Demodulation** -- For a given bandwidth, the instantaneous magnitude or amplitude of a specific carrier frequency sinusoid.
- **Complex Demodulation** -- For a given bandwidth, the instantaneous complex vector (Cartesian) of a specific carrier frequency sinusoid.
- **Frequency Demodulation** -- This is based on the phase of the sequential vectors compared with the expected phase since the last vector (the derivative of the phase error) or the rate of phase movement (in Hz).
- **Imaginary Component Demodulation** -- "Quadrature-phase" component "Q".
- **Phase Demodulation** -- This is based on the phase of sequential vectors, as compared to the "expected ideal" phase. Closely related to Time Interval Error, but with a change in sign since positive phase error implies early edge arrival (negative TIE).
- **Real Component Demodulation** -- the "In-phase" component "I".
- **Wideband AM** -- Wideband amplitude demodulation

These demodulated waveforms are useful for many purposes:

- To analyze FM or PM modulated signals
- To study unwanted variations in any of these domains (frequency or phase "noise" analysis)
- To study unwanted systematic "pickup" or interference on either transmitted RF, or on oscillators, phase-locked loops etc.
- To study instantaneous power
- To study envelopes of amplitude modulated signals with variable bandwidth.

Only two of the result types are rescalable, Frequency (FM) and Phase (PM), since the magnitudes of these projections cannot be known beforehand. All of the other results are scaled on the vertical scale of the original digitized carrier waveform.

There are no parameters specific to the Demodulation math function.

Theory of Operation

The basic procedure is a localized (by windowing) complex finite impulse response (FIR), which amounts to no less than a local (windowed) discrete complex Fourier "term" (or sum) at the carrier frequency.

The length of the complex FIR is determined by the selection of Bandwidth. The result of each convolution with the FIR at a given time offset is then translated into a single complex vector, defining the instantaneous phase and amplitude of the modulated carrier. The user selects one of several "views" on this vector (including its amplitude, phase, rate of change, real, imaginary, or complex). The appropriate values from the vector constitute the samples of the resulting processed waveform.

Using the same window and bandwidth criteria, there is also a "wide-band" AM demodulation function. This function doesn't produce a complex vector for each data point of the resulting function, but simply uses the instantaneous rms signal to produce a scaled output. Basically there is no complex FIR, only the window. The scaling is such as to show (for practically any carrier frequency) an envelope of the same magnitude as the sinusoid.

To Set Up Demodulation

1. From the menu bar, select **Math**, then **Math Setup...** from the drop-down menu.
2. Touch a Math function tab **F1** to **F8**.
3. Touch inside the "Source"1 field and select an input waveform from the pop-up menu.
4. Touch inside the "Operator1" field and select **Demodulate** from the pop-up menu.
5. Touch the **Demodulate** tab in the right-hand dialog.
6. Touch inside the "Demodulation" field and select a modulation mode:



7. Touch inside the "Carrier Freq." field and enter the frequency of the carrier wave, using the pop-up keypad.
8. Touch inside the "Decimate by" field and enter a value by which to "thin out" your input waveform. Decimation will speed up processing.
9. If you selected **Phase** or **Frequency** modulation from the "Demodulation" menu, touch inside the "Scale" field and enter a value to rescale the waveform to. The units for phase modulation (PM) will be in radians per division, and Hz per division for frequency modulation (FM).
10. Touch inside the "Bandwidth" field and enter the bandwidth of your source waveform.

11. Touch inside the "Max # taps" field and enter a value for the maximum allowable filter taps.

Note: The actual number of taps used by the filter depends on the sampling rate and bandwidth selected. With the sampling rate held constant, the number of filter taps decreases as the bandwidth increases. With the bandwidth held constant, the number of filter taps increases as sampling rate increases.

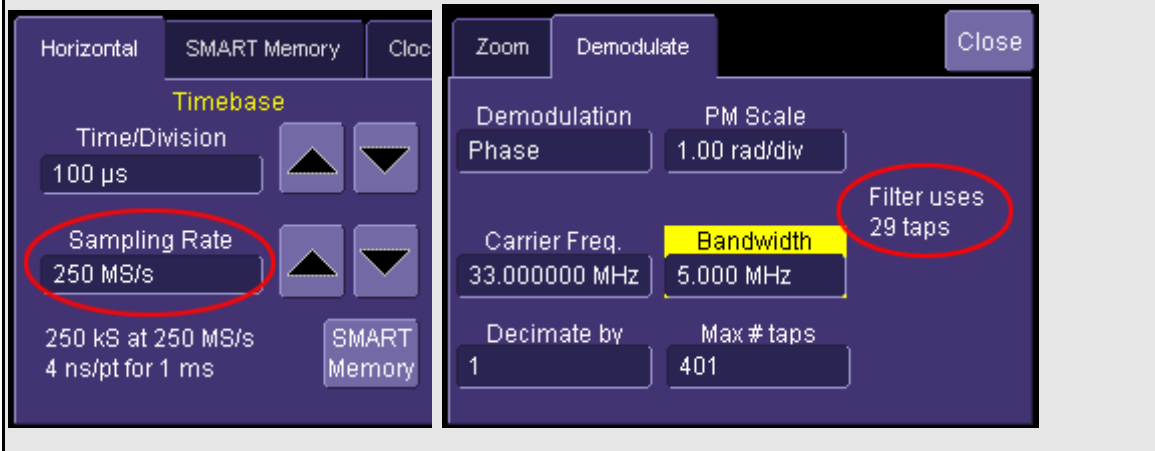

FFT

Why Use FFT?

For a large class of signals, you can gain greater insight by looking at spectral representation rather than time description. Signals encountered in the frequency response of amplifiers, oscillator phase noise and those in mechanical vibration analysis, for example, are easier to observe in the frequency domain.

If sampling is done at a rate fast enough to faithfully approximate the original waveform (usually five times the highest frequency component in the signal), the resulting discrete data series will uniquely describe the analog signal. This is of particular value when dealing with transient signals because, unlike FFT, conventional swept spectrum analyzers cannot handle them.

Spectral analysis theory assumes that the signal for transformation is of infinite duration. Since no physical signal can meet this condition, a useful assumption for reconciling theory and practice is to view the signal as consisting of an infinite series of replicas of itself. These replicas are multiplied by a rectangular window (the display grid) that is zero outside of the observation grid.

An FFT operation on an N-point time domain signal can be compared to passing the signal through a comb filter consisting of a bank of N/2 filters. All the filters have the same shape and width and are centered at N/2 discrete frequencies. Each filter collects the signal energy that falls into the immediate neighborhood of its center frequency. Thus it can be said that there are N/2 frequency bins. The distance in Hz between the center frequencies of two neighboring bins is always the same: Δf .

Power (Density) Spectrum

Because of the linear scale used to show magnitudes, lower amplitude components are often hidden by larger components. In addition to the functions offering magnitude and phase representations, the FFT option offers power density and power spectrum density functions. These

latter functions are even better suited for characterizing spectra. The power spectrum (V^2) is the square of the magnitude spectrum (0 dBm corresponds to voltage equivalent to 1 mW into 50 ohms.) This is the representation of choice for signals containing isolated peaks --- periodic signals, for instance.

The power density spectrum (V^2/Hz) is the power spectrum divided by the equivalent noise bandwidth of the filter associated with the FFT calculation. This is best employed for characterizing broadband signals such as noise.

Memory for FFT

The amount of acquisition memory available will determine the maximum range (Nyquist frequency) over which signal components can be observed. Consider the problem of determining the length of the observation window and the size of the acquisition buffer if a Nyquist rate of 500 MHz and a resolution of 10 kHz are required. To obtain a resolution of 10 kHz, the acquisition time must be at least:

$$T = 1/\Delta f = 1/10 \text{ kHz} = 100 \text{ ms}$$

For a digital oscilloscope with a memory of 100 kB, the highest frequency that can be analyzed is:

$$\Delta f \times N/2 = 10 \text{ kHz} \times 100 \text{ kB}/2 = 500 \text{ MHz}$$

FFT Pitfalls to Avoid

Take care to ensure that signals are correctly acquired: improper waveform positioning within the observation window produces a distorted spectrum. The most common distortions can be traced to insufficient sampling, edge discontinuities, windowing or the "picket fence" effect.

Because the FFT acts like a bank of band-pass filters centered at multiples of the frequency resolution, components that are not exact multiples of that frequency will fall within two consecutive filters. This results in an attenuation of the true amplitude of these components.

Picket Fence and Scallop

The highest point in the spectrum can be 3.92 dB lower when the source frequency is halfway between two discrete frequencies. This variation in spectrum magnitude is the picket fence effect. The corresponding attenuation loss is referred to as scallop loss. LeCroy scopes automatically correct for the scallop effect, ensuring that the magnitude of the spectra lines correspond to their true values in the time domain.

If a signal contains a frequency component above Nyquist, the spectrum will be aliased, meaning that the frequencies will be folded back and spurious. Spotting aliased frequencies is often difficult, as the aliases may ride on top of real harmonics. A simple way of checking is to modify the sample rate and observe whether the frequency distribution changes.

Leakage

FFT assumes that the signal contained within the time grid is replicated endlessly outside the observation window. Therefore if the signal contains discontinuities at its edges, pseudo-frequencies will appear in the spectral domain, distorting the real spectrum. When the start and end phase of the signal differ, the signal frequency falls within two frequency cells, broadening the spectrum.

The broadening of the base, stretching out in many neighboring bins, is termed leakage. Cures for this are to ensure that an integral number of periods is contained within the display grid or that no discontinuities appear at the edges. Another is to use a window function to smooth the edges of the signal.

Choosing a Window

The choice of a spectral window is dictated by the signal's characteristics. Weighting functions control the filter response shape, and affect noise bandwidth as well as side lobe levels. Ideally, the main lobe should be as narrow and flat as possible to effectively discriminate all spectral components, while all side lobes should be infinitely attenuated. The window type defines the bandwidth and shape of the equivalent filter to be used in the FFT processing.

In the same way as one would choose a particular camera lens for taking a picture, some experimenting is generally necessary to determine which window is most suitable. However, the following general guidelines should help.

Rectangular windows provide the highest frequency resolution and are thus useful for estimating the type of harmonics present in the signal. Because the rectangular window decays as a $(\sin x)/x$ function in the spectral domain, slight attenuation will be induced. Alternative functions with less attenuation (Flat Top and Blackman-Harris) provide maximum amplitude at the expense of frequency resolution. Whereas, Hamming and Von Hann are good for general purpose use with continuous waveforms.

Window Type	Applications and Limitations
Rectangular	These are normally used when the signal is transient (completely contained in the time-domain window) or known to have a fundamental frequency component that is an integer multiple of the fundamental frequency of the window. Signals other than these types will show varying amounts of spectral leakage and scallop loss, which can be corrected by selecting another type of window.
Hanning (Von Hann)	These reduce leakage and improve amplitude accuracy. However, frequency resolution is also reduced.
Hamming	These reduce leakage and improve amplitude accuracy. However, frequency resolution is also reduced.
Flat Top	This window provides excellent amplitude accuracy with moderate reduction of leakage, but with reduced frequency resolution.
Blackman-Harris	It reduces the leakage to a minimum, but with reduced frequency resolution.

FFT Window Filter Parameters				
Window Type	Highest Side Lobe (dB)	Scallop Loss (dB)	ENBW (bins)	Coherent Gain (dB)
Rectangular	-13	3.92	1.0	0.0
von Hann	-32	1.42	1.5	-6.02
Hamming	-43	1.78	1.37	-5.35
Flat Top	-44	0.01	2.96	-11.05
Blackman-Harris	-67	1.13	1.71	-7.53

Improving Dynamic Range

Enhanced resolution uses a low-pass filtering technique that can potentially provide for three additional bits (18 dB) if the signal noise is uniformly distributed (white). Low-pass filtering should be considered when high frequency components are irrelevant. A distinct advantage of this technique is that it works for both repetitive and transient signals. The SNR increase is conditioned by the cut-off frequency of the ERES low-pass filter and the noise shape (frequency distribution).

LeCroy digital oscilloscopes employ FIR digital filters so that a constant phase shift is maintained. The phase information is therefore not distorted by the filtering action.

Record Length

Because of its versatility, FFT analysis has become a popular analysis tool. However, some care must be taken with it. In most instances, incorrect positioning of the signal within the display grid will significantly alter the spectrum. Effects such as leakage and aliasing that distort the spectrum must be understood if meaningful conclusions are to be arrived at when using FFT.

An effective way to reduce these effects is to maximize the acquisition record length. Record length directly conditions the effective sampling rate of the scope and therefore determines the frequency resolution and span at which spectral analysis can be carried out.

FFT Algorithms

A summary of the algorithms used in the oscilloscope's FFT computation is given here in a few steps:

1. The data are multiplied by the selected window function.
2. FFT is computed, using a fast implementation of the DFT (Discrete Fourier Transform):

$$X_n = \frac{1}{N} \sum_{k=0}^{N-1} x_k \times W^{nk}$$

where: x_k is a complex array whose real part is the modified source time domain waveform,

and whose imaginary part is 0; X_n is the resulting complex frequency-domain waveform; $W = e^{-2\pi j n / N}$; and N is the number of points in x_k and X_n .

The generalized FFT algorithm, as implemented here, works on N , which need *not* be a power of 2.

3. The resulting complex vector X_n is divided by the coherent gain of the window function, in order to compensate for the loss of the signal energy due to windowing. This compensation provides accurate amplitude values for isolated spectrum peaks.
4. The real part of X_n is symmetric around the Nyquist frequency, that is

$$R_n = R_{N-n}$$

while the imaginary part is asymmetric, that is

$$I_n = -I_{N-n}$$

The energy of the signal at a frequency n is distributed equally between the first and the second halves of the spectrum; the energy at frequency 0 is completely contained in the 0 term.

The first half of the spectrum (Re, Im), from 0 to the Nyquist frequency is kept for further processing and doubled in amplitude:

$$R'_n = 2 \times R_{n_0} \quad n < N/2$$

$$I'_n = 2 \times I_{n_0} \quad n < N/2$$

5. The resultant waveform is computed for the spectrum type selected.

If "Magnitude" is selected, the magnitude of the complex vector is computed as:

$$M_n = \sqrt{R_n^2 + I_n^2}$$

Steps 1-5 lead to the following result:

An AC sine wave of amplitude 1.0 V with an integral number of periods N_p in the time window, transformed with the rectangular window, results in a fundamental peak of 1.0 V magnitude in the spectrum at frequency $N_p \times \Delta f$. However, a DC component of 1.0 V, transformed with the rectangular window, results in a peak of 2.0 V magnitude at 0 Hz.

The waveforms for the other available spectrum types are computed as follows:

$$\text{Phase: angle} = \arctan (I_n/R_n) \quad M_n > M_{min}$$

$$\text{angle} = 0 \quad M_n \leq M_{min}$$

Where M_{min} is the minimum magnitude, fixed at about 0.001 of the full scale at any gain setting, below which the angle is not well defined.

The dBm Power Spectrum:

$$dBm PS = 10 \times \log_{10} \left(\frac{M_n^2}{M_{ref}^2} \right) = 20 \times \log_{10} \left(\frac{M_n}{M_{ref}} \right)$$

where $M_{ref} = 0.316$ V (that is, 0 dBm is defined as a sine wave of 0.316 V peak or 0.224 V rms, giving 1.0 mW into 50 ohms).

The dBm Power Spectrum is the same as dBm Magnitude, as suggested in the above formula.

dBm Power Density:

$$dBm PD = dBm PS - 10 \times \log_{10} (ENBW \times \Delta f)$$

where $ENBW$ is the equivalent noise bandwidth of the filter corresponding to the selected window, and $Delta f$ is the current frequency resolution (bin width).

6. The FFT Power Average takes the complex frequency-domain data R'_n and I'_n for each spectrum generated in Step 5, and computes the square of the magnitude:

$$M_n^2 = R_n'^2 + I_n'^2,$$

then sums M_n^2 and counts the accumulated spectra. The total is normalized by the number of spectra and converted to the selected result type using the same formulas as are used for the Fourier Transform.

Glossary

This section defines the terms frequently used in FFT spectrum analysis and relates them to the oscilloscope.

Aliasing If the input signal to a sampling acquisition system contains components whose frequency is greater than the Nyquist frequency (half the sampling frequency), there will be less than two samples per signal period. The result is that the contribution of these components to the sampled waveform is indistinguishable from that of components below the Nyquist frequency. This is **aliasing**.

The timebase and transform size should be selected so that the resulting Nyquist frequency is higher than the highest significant component in the time-domain record.

Coherent Gain The normalized coherent gain of a filter corresponding to each window function is 1.0 (0 dB) for a rectangular window and less than 1.0 for other windows. It defines the loss of signal energy due to the multiplication by the window function. This loss is compensated for in the oscilloscope. The following table lists the values for the implemented windows.

Window Frequency Domain Parameters				
Window Type	Highest Side Lobe (dB)	Scallop Loss (dB)	ENBW (bins)	Coherent Gain (dB)
Rectangular	-13	3.92	1.0	0.0
Hanning (Von Hann)	-32	1.42	1.5	-6.02
Hamming	-43	1.78	1.37	-5.35
Flattop	-44	0.01	2.96	-11.05
Blackman-Harris	-67	1.13	1.71	-7.53

ENBW Equivalent Noise BandWidth (ENBW) is the bandwidth of a rectangular filter (same gain at the center frequency), equivalent to a filter associated with each frequency bin, which would collect the same power from a white noise signal. In the table on the previous page, the ENBW is listed for each window function implemented, given in bins.

Filters Computing an N-point FFT is equivalent to passing the time-domain input signal through N/2 filters and plotting their outputs against the frequency. The spacing of filters is $\Delta f = 1/T$, while the bandwidth depends on the window function used (see Frequency Bins).

Frequency Bins The FFT algorithm takes a discrete source waveform, defined over N points, and computes N complex Fourier coefficients, which are interpreted as harmonic components of the input signal.

For a real source waveform (imaginary part equals 0), there are only N/2 independent harmonic components.

An FFT corresponds to analyzing the input signal with a bank of N/2 filters, all having the same shape and width, and centered at N/2 discrete frequencies. Each filter collects the signal energy that falls into the immediate neighborhood of its center frequency. Thus it can be said that there are N/2 "frequency bins."

The distance in hertz between the center frequencies of two neighboring bins is always:

$$\Delta f = 1/T$$

where T is the duration of the time-domain record in seconds.

The width of the main lobe of the filter centered at each bin depends on the window function used. The rectangular window has a nominal width at 1.0 bin. Other windows have wider main lobes (see table).

Frequency Range The range of frequencies computed and displayed is 0 Hz (displayed at the left-hand edge of the screen) to the Nyquist frequency (at the rightmost edge of the trace).

Frequency Resolution In a simple sense, the frequency resolution is equal to the bin width Δf . That is, if the input signal changes its frequency by Δf , the corresponding spectrum peak will be displaced by Δf . For smaller changes of frequency, only the shape of the peak will change.

However, the effective frequency resolution (that is, the ability to resolve two signals whose frequencies are almost the same) is further limited by the use of window functions. The ENBW value of all windows other than the rectangular is greater than Δf and the bin width. The table of Window Frequency-Domain Parameters lists the ENBW values for the implemented windows.

Leakage In the power spectrum of a sine wave with an integral number of periods in the (rectangular) time window (that is, the source frequency equals one of the bin frequencies), the spectrum contains a sharp component whose value accurately reflects the source waveform's amplitude. For intermediate input frequencies this spectral component has a lower and broader peak.

The broadening of the base of the peak, stretching out into many neighboring bins, is termed *leakage*. It is due to the relatively high side lobes of the filter associated with each frequency bin.

The filter side lobes and the resulting leakage are reduced when one of the available window functions is applied. The best reduction is provided by the Blackman-Harris and Flattop windows. However, this reduction is offset by a broadening of the main lobe of the filter.

Number of Points The FFT is computed over the number of points (Transform Size) whose upper bounds are the source number of points, and by the maximum number of points selected in the menu. The FFT generates spectra of $N/2$ output points.

Nyquist Frequency The Nyquist frequency is equal to one half of the effective sampling frequency (after the decimation): $\Delta f \times N/2$.

Picket Fence Effect If a sine wave has a whole number of periods in the time domain record, the power spectrum obtained with a rectangular window will have a sharp peak, corresponding exactly to the frequency and amplitude of the sine wave. Otherwise the spectrum peak with a rectangular window will be lower and broader.

The highest point in the power spectrum can be 3.92 dB lower (1.57 times) when the source frequency is halfway between two discrete bin frequencies. This variation of the spectrum magnitude is called the *picket fence effect* (the loss is called the scallop loss).

All window functions compensate for this loss to some extent, but the best compensation is obtained with the Flattop window.

Power Spectrum The power spectrum (V^2) is the square of the magnitude spectrum.

The power spectrum is displayed on the dBm scale, with 0 dBm corresponding to:

$$V_{\text{ref}}^2 = (0.316 V_{\text{peak}})^2,$$

where V_{ref} is the peak value of the sinusoidal voltage, which is equivalent to 1 mW into 50 ohms.

Power Density Spectrum The power density spectrum (V^2/Hz) is the power spectrum divided by the equivalent noise bandwidth of the filter, in hertz. The power density spectrum is displayed on

the dBm scale, with 0 dBm corresponding to (V_{ref}^2/Hz) .

Sampling Frequency The time-domain records are acquired at sampling frequencies dependent on the selected time base. Before the FFT computation, the time-domain record may be decimated. If the selected maximum number of points is lower than the source number of points, the effective sampling frequency is reduced. The effective sampling frequency equals twice the Nyquist frequency.

Scallop Loss This is loss associated with the picket fence effect.

Window Functions All available window functions belong to the sum of cosines family with one to three non-zero cosine terms:

$$W_k = \sum_{m=0}^{M-1} a_m \cos\left(\frac{2\pi k}{N} m\right) \quad 0 \leq k < N$$

where: $M=3$ is the maximum number of terms, a_m are the coefficients of the terms, N is the number of points of the decimated source waveform, and k is the time index.

The table of Coefficients of Window Functions lists the coefficients a_m . The window functions seen in the time domain are symmetric around the point $k = N/2$.



Coefficients of Window Functions			
Window Type	a_0	a_1	a_2
Rectangular	1.0	0.0	0.0
Hanning (Von Hann)	0.5	-0.5	0.0
Hamming	0.54	-0.46	0.0
Flattop	0.281	-0.521	0.198
Blackman-Harris	0.423	-0.497	0.079



FFT Setup

To Set Up an FFT

1. In the menu bar touch **Math**, then **Math Setup...** in the drop-down menu.
2. Touch a Math function trace button: **F1** through **Fx** The number of math traces available depends on the software options loaded on your scope. See Specifications.; a pop-up

menu appears. Select **FFT**  from the menu.

3. Touch the **Single**  or **Dual** (function of a function)  button if the FFT is to be of the result of another math operation.
4. Touch inside the **Source1** field and select a channel, memory, or math trace on which to perform the FFT.

5. Touch inside the **Operator1** field: Select **FFT** from the pop-up menu if you selected **Single** function. Select another math function if you selected **Dual** function. Then touch inside the **Operator2** field and select **FFT** from the pop-up menu.
6. In the right-hand dialog, touch the **FFT** tab.
7. Choose whether to **Truncate**¹  or **Zero-fill**²  the trace display.
8. Touch the **Suppress DC** checkbox if you want to make the DC bin go to zero. Otherwise, leave it unchecked.
9. Touch inside the **Output** type field, and make a selection from the pop-up menu.
10. Touch inside the **Window** field, select a window type.
11. Touch inside the **Algorithm** field and select either **Least Prime**³ or **Power of 2**⁴ from the pop-up menu.

¹ When the FFT transform size does not match the record length, you can truncate the record and perform an FFT on the shorter record. This will increase the resolution bandwidth.

² Zero-fill is useful when the source data for the FFT comes from a math operation that shortens the record. This is commonly encountered in filtering operations like enhanced resolution. The missing data points are replaced by data values, whose amplitudes are interpolated to fit between the last data point and the first data point in the record. This guarantees that there is not a first-order discontinuity in the filled data. Since the data at the end of the record is "filled" data, it is advisable to select a weighting window other than rectangular to minimize the effect of the fill on the resulting spectrum.

³ The default algorithm is a least primes algorithm that computes FFTs on transform sizes having lengths that can be expressed as factors of $2^N \cdot 5^K$. This is very compatible with the record lengths encountered in the oscilloscope, which are often multiples of 1, 2, 4, 5, or 10.

⁴ The other choice is a power of two algorithm where the record lengths are in the form of 2^N . The power of 2 algorithm generally runs faster than the least primes algorithm. The price that is paid is a record length that is not the same as the acquired signal. The power-of-two FFT uses the first 2^N points of the record. For example, if you acquire 500 points in your trace, the power-of-two FFT would only use the first 256 points.

ANALYSIS

Pass/Fail Testing

Comparing Parameters

Each Pass/Fail input (**Qx**) can compare a different parameter result to a user-defined limit (or statistical range) under a different condition.

The conditions are represented by these comparison operators:

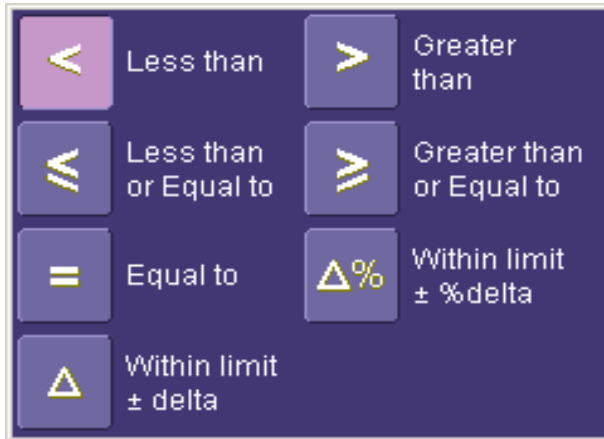

At the touch of a button, test results can also be compared to these standard statistical limits:

- current mean
- mean + 1 SD
- mean + 3 SD

In Dual Parameter Compare mode, your X-Stream scope gives you the option to compare to each other parameter results measured on two different waveforms. You can set your test to be true if Any waveform or All waveforms fit the criterion stipulated by the comparison condition. Your setup is conveniently shown in the Summary box of the **Qx** dialog. For example:

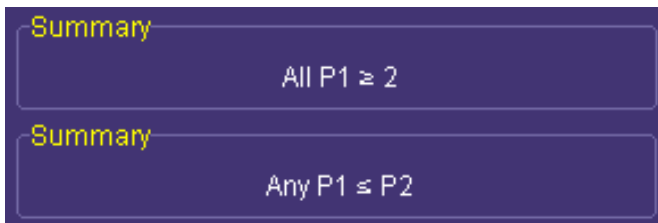

Mask Tests

You have the choice to do mask testing by using an existing mask, or by using a mask created from your actual waveform, with vertical and horizontal tolerances that you define. Existing masks can

be loaded from a floppy disk or from a network.

You can set your mask test to be True for waveforms All In, All Out, Any In, or Any Out. For example, if you select All In, the test will be False if even a single waveform falls outside the mask.

Masks that you create from your waveform can be confined to just a portion of the trace by use of a measure gate. (See Measure Gate for an explanation of how this feature works.)

Actions

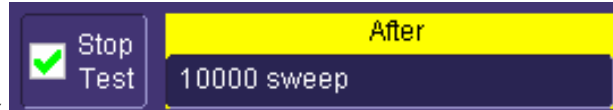

By touching the **Stop Test** checkbox in the "Actions" dialog, you can set up the test to end after a predetermined number of sweeps that you decide.

You can also decide the actions to occur upon your waveforms' passing or failing, by selecting one or all of the following:

- stop
- audible alarm
- print image of display
- emit pulse
- save waveform

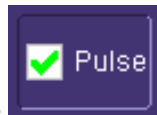

The selection **Pulse** causes a pulse to be output through the Aux Out connector at the front of the scope. This pulse can be used to trigger another scope. You can set the amplitude and width of the pulse as described in Auxiliary Output Signals.

Depending on your scope model, you can configure up to 8 pass/fail conditions. The Boolean conditions to determine if your waveform passes are as follows:

All True	All False
Any True	Any False
All Q1 to Q4 Or All Q5 to Q8	Any Q1 to Q4 And Any Q5 to Q8

Setting Up Pass/Fail Testing

Initial Setup



1. Touch **Analysis** in the menu bar, then **Pass/Fail Setup...** in the drop-down menu.
2. Touch the **Actions** tab.
3. Touch the **Enable Actions** checkbox. This will cause the actions that you will select to occur upon your waveform's passing or failing a test.

4. Touch the **Summary View** to enable a line of text

Last = True Passed 1 Of 1 sweeps  that shows concisely the status of your last waveform and keeps a running count of how many sweeps have passed.

5. Touch inside the **Pass If** field, and select a Boolean condition from the pop-up menu.
6. If you want to set up the test to end after a finite number of sweeps, touch the **Stop Test** checkbox. Then touch inside the **After** data entry field and enter a value, using the pop-up numeric keypad.



7. Under "If", touch either the **Pass**  or **Fail**  button to set the actions to occur upon your waveform's passing or failing the test.
8. Under "Then", touch the actions you want to occur: stop test, sound alarm, print result, emit pulse, or save the waveform. If you want to have the results printed and your scope is not equipped with a printer, be sure that it is connected to a local or network printer. See Printing.
9. If you want to save your waveform automatically, touch the **Save Setup**. This will take you out of the current dialog and will open the "Save Waveform" dialog. See Saving and Recalling Waveforms.
10. Test your Pass/Fail conditions by touching the **Force Actions Once** button. Press the **Clear All** button to quickly uncheck all checkboxes if you want to change your selections.

Comparing a Single Parameter

1. Touch **Analysis** in the menu bar, then **Pass/Fail Setup...** in the drop-down menu.
2. Touch a **Qx** tab; a setup dialog for that position will open.
3. Touch inside the **Source1** field and select a source from the pop-up menu.





4. Touch inside the **Condition** field in the main dialog and select **ParamCompare** .
5. Touch inside the **Compare Values** field and select **All** or **Any** from the pop-up menu

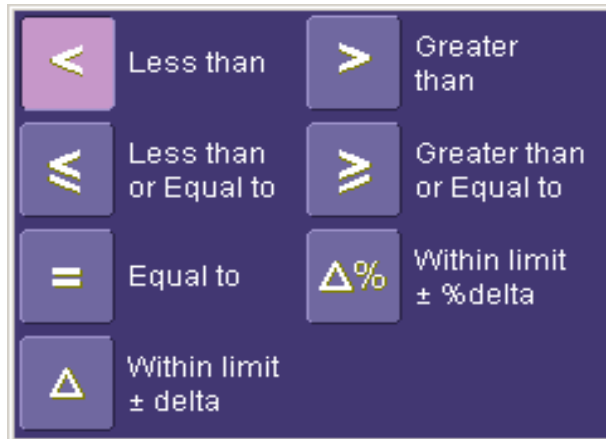

By selecting **All**, the test will be true only if every waveform falls within the limit that you will set. By selecting **Any**, the test will be true if just one waveform falls within the limit.

6. Touch inside the **Condition** field in the "ParamCompare" mini-dialog and select a math operator from the pop-up menu:



7. Touch inside the **Limit** field and enter a value, using the pop-up numeric keypad. This value takes the dimensions of the parameter that you are testing. For example, if you are testing a time parameter, the unit is seconds. If you chose either **WithinDeltaPct**  or **WithinDeltaAbs**  from the **Condition** menu, you also have the choice of setting the limit by means of the statistical buttons at the bottom of the "ParamCompare" dialog:



Comparing Dual Parameters

1. Touch **Analysis** in the menu bar, then **Pass/Fail Setup...** in the drop-down menu.
2. Touch a **Qx** tab; a setup dialog for that position will open.
3. Touch inside the **Condition** field in the main dialog and select **DualParamCompare** 
4. Touch inside the **Source1** and **Source2** fields and select a source from the pop-up menu.
5. Touch inside the "ParamCompare" mini-dialog field and select a source from the pop-up menu.
6. Touch inside the **Compare Values** field and select **All** or **Any** from the pop-up menu



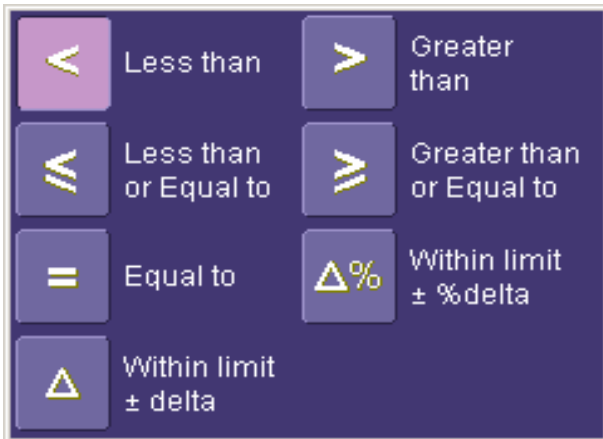

By selecting **All**, the test will be true only if every waveform falls within the limit that you will set. By selecting **Any**, the test will be true if just one waveform falls within the limit.

7. Touch inside the **Condition** field in the "ParamCompare" mini-dialog and select a math operator from the pop-up menu:



8. Touch inside the **Limit** field and enter a value, using the pop-up numeric keypad. This value takes the dimension of the parameter that you are testing. For example, if you are testing a time parameter, the unit is seconds.

9. If you chose either **WithinDeltaPct**  or **WithinDeltaAbs**  from the **Condition** menu, touch inside the **Delta** field and enter a value.

Mask Testing

1. Touch **Analysis** in the menu bar, then **Pass/Fail Setup...** in the drop-down menu.
2. Touch a **Qx** tab; a setup dialog for that position will open.
3. Touch inside the **Source1** field and select a source from the pop-up menu.
4. Touch inside the **Condition** field in the main dialog and select **Mask Test** .
5. From the "Test" mini-dialog, make a selection in the **Test is True when** group of buttons.

This selection means, for example, that if you select **All In** the test will be False if even a single waveform falls outside the mask.

6. From **Show Markers**, choose whether or not to have mask violations displayed.
7. If you are loading a pre-existing mask, touch the **Load Mask** tab, then the **File** button. You can then enter the file name or browse to its location.
8. If you want to make a mask from your waveform, touch the **Make Mask** tab.
9. Touch inside the **Ver Delta** and **Hor Delta** fields and enter boundary values, using the pop-up numeric keypad.
10. Touch the **Browse** button to create a file name and location for the mask if you want to save it.
11. Touch the **Gate** tab, then enter values in the **Start** and **Stop** fields to constrain the mask to a portion of the waveform. Or, you can simply touch and drag the Gate posts, which initially are placed at the extreme left and right ends of the grid.

UTILITIES

Status

The status read-only dialog displays system information including serial number, firmware version, and installed software and hardware options.

To Access Status Dialog

1. In the menu bar, touch **Utilities**.
2. Touch the **Status** tab.

Remote communication

The Remote dialog is where you can select a network communication protocol, establish network connections, and configure the Remote Control Assistant log. The choice of communication protocols is limited to TCPIP and GPIB.

Note: GPIB is an option and requires a GPIB card to be installed in a card slot at the rear of the scope.

Note: The instrument uses Dynamic Host Configuration Protocol (DHCP) as its addressing protocol. Therefore, it is not necessary to set up an IP address if your network supports DHCP. If it does not, you can assign a static address in the standard Windows 2000 network setup menu.

The Remote Control Assistant monitors communication between your PC and scope when you are operating the instrument remotely. You can log all events, or errors only. This log can be invaluable when you are creating and debugging remote control applications.

To Set Up Remote Communication.

If you are connecting the scope to a network, first contact your Information Systems administrator. If you are connecting the scope directly to your PC, connect a GPIB or Ethernet cable between them.

1. In the menu bar touch **Utilities**, then **Utilities Setup...** in the drop-down menu.
2. Touch the **Remote** tab.
3. Make a **Port** selection: **TCPIP** (transmission control protocol/Internet protocol) or **GPIB** (general purpose interface bus). If you do not have a GPIB card installed, the GPIB selection will not be accessible.
4. If you are using GPIB, set a GPIB address by touching inside the **GPIB Address** data entry field and enter an address.
5. Press the **Net Connections** button; the Windows **Network and Dial-up Connections** window appears.
6. Touch **Make New Connection** and use the Windows Network Connection Wizard to make a new connection; or, touch Local Area Connection to reconfigure the scope's connection if it is already connected to the network.

To Configure the Remote Control Assistant Event Log

1. In the menu bar touch **Utilities**, then **Utilities Setup...** in the drop-down menu.
2. Touch the **Remote** tab.

3. Touch inside the **Log Mode** data entry field.
4. Select **Off**, **Errors Only**, or **Full Dialog** from the pop-up menu.
5. To export the contents of the event log to an ASCII text file, touch the **Show Remote Control Log** button: the "Event Logs" popup window appears. Touch inside the **DestFilename** data entry field and enter a file name, using the pop-up keyboard. Then touch the **Export to Text File** button.

Hardcopy

Printing

For print setup, refer to Printing.

Clipboard

This selection prints to the clipboard so you can paste a file into another application (like MS Word, for example).

To Print from the Clipboard

1. In the menu bar touch **Utilities**, then **Utilities Setup...** in the drop-down menu.
2. Touch the **Hardcopy** tab.
3. Under **Colors**, touch the **Use Print Colors** checkbox if you want the traces printed on a white background. A white background saves printer toner.
4. Touch the **Grid Area Only** checkbox if you do not need to print the dialog area and you only want to show the waveforms and grids.
5. Touch the **Print Now** button.

File

Choose **File** if you want to output the screen image to storage media such as floppy drive or hard drive. When outputting to floppy disk, be sure to use a preformatted disk.

To Print to File

1. In the menu bar touch **Utilities**, then **Utilities Setup...** in the drop-down menu.
2. Touch the **Hardcopy** tab, then the **File** icon.
3. Touch inside the **File Format** data entry field and select a graphic file format from the pop-up menu.
4. Under **Colors**, touch the **Use Print Colors** checkbox if you want the traces printed on a white background. A white background saves printer toner.
5. Touch inside the **Directory** data entry field and type the path to the folder you want to print to, using the pop-up keyboard. Or touch the **Browse** button and navigate to the folder.
6. Touch inside the **File Name** data entry field and enter a name for the display image, using the pop-up keyboard.
7. Touch the **Grid Area Only** checkbox if you do not need to print the dialog area and you

only want to show the waveforms and grids.

8. Touch the **Print Now** button.

E-Mail

The instrument also gives you the option to e-mail your screen images, using either the MAPI or SMTP protocols. Before you output to e-mail from the Utilities dialog, you first have to set up the e-mail server and recipient address in **Preference Setup**.

To Send E-mail

1. In the menu bar touch **Utilities**, then **Utilities Setup...** in the drop-down menu.
2. Touch the **Hardcopy** tab, then the **E-mail** button.
3. Touch inside the **File Format** data entry field and select a graphic file format from the pop-up menu.
4. Under **Colors**, touch the **Use Print Colors** checkbox if you want the traces printed on a white background. A white background saves printer toner.
5. Touch the **Prompt for message to send with mail** checkbox if you want to include remarks with the image.
6. Touch the **Grid Area Only** checkbox if you do not need to print the dialog area and you only want to show the waveforms and grids.
7. Touch the **Print Now** button.

Aux Output

Refer to Auxiliary Output Signals.

Date & Time

The instrument gives you the choice of manually setting the time and date or getting it from the Internet. If you elect to get the time and date from the Internet, you need to have the scope connected to the Internet through the LAN connector on the rear panel. You can also set time zones and daylight savings time.

To Set Time and Date Manually

1. In the menu bar touch **Utilities**, then **Utilities Setup...** in the drop-down menu.
2. Touch the **Date/Time** tab.
3. Touch inside each of the **Hour**, **Minute**, **Second**, **Day**, **Month**, and **Year** data entry fields and enter a value, using the pop-up numeric keypad.
4. Touch the **Validate Changes** button.

To Set Time and Date from the Internet

The Simple Network Time Protocol (SNTP) is used.

1. Ensure that the scope is connected to the Internet through the LAN connector at the rear of

the scope.

2. In the menu bar touch **Utilities**, then **Utilities Setup...** in the drop-down menu.
3. Touch the **Date/Time** tab.
4. Touch the **Set from Internet** button.

To Set Time and Date from Windows

1. In the menu bar touch **Utilities**, then **Utilities Setup...** in the drop-down menu.
2. Touch the **Date/Time** tab.



3. Touch the **Windows Date/Time** button .
4. Use the **Time & Date Properties** window to configure the time, including time zone:

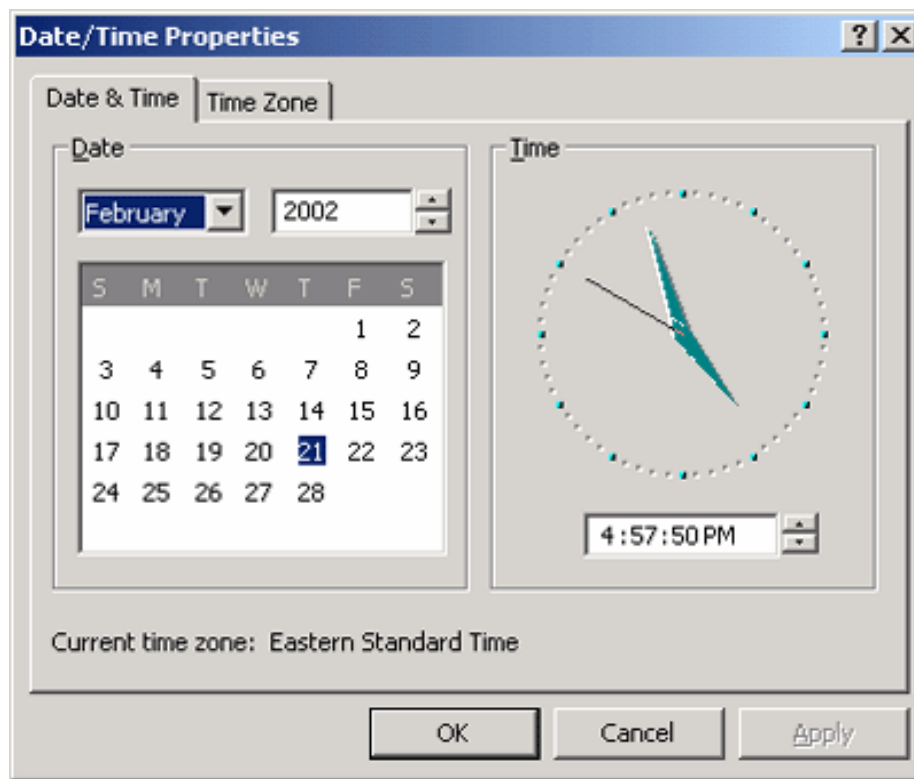

Options

Use this dialog to add or remove software options. For information about software options, contact your local LeCroy Sales and Service office, or visit our Web site at <http://www.lecroy.com/options>.

Options that you purchase, such as JTA2, add performance to you instrument. This added performance is seen in the new math functions or parameters that you can choose from when doing Measure or Math setups.

Preferences

Audible Feedback

You can elect to have audible confirmation each time you touch a screen or front panel control.

1. In the menu bar touch **Utilities**; then touch **Preferences** in the drop-down menu.
2. Touch the "Audible Feedback" **Enable** checkbox so that the scope emits a beep with each touch of the screen or front panel control.

Auto-calibration

You can choose to have your instrument automatically recalibrate itself whenever there is a significant change in ambient temperature. If you do not enable this option, the scope will only recalibrate at startup and whenever you make a change to certain operating conditions.

1. In the menu bar touch **Utilities**; then touch **Preferences** in the drop-down menu.
2. Touch the "Automatic Calibration" **Enable** checkbox.

Offset Control

As you change the gain, this control allows you to either keep the vertical offset level indicator stationary (when **Div** is selected) or to have it move with the actual voltage level (when **Volts** is selected). The advantage of selecting **Div** is that the waveform will remain on the grid as you increase the gain; whereas, if **Volts** is selected, the waveform could move off the grid.

Note: Regardless of whether you select **Volts** or **Div**, the "Offset" shown in the channel setup dialog always indicates volts. However, when **Div** is selected for the Offset Control, the offset in volts is scaled proportional to the change in gain, thereby keeping the division on the grid constant.

1. In the menu bar touch **Utilities**; then touch **Preferences** in the drop-down menu.
2. Touch the **Acquisition** tab.
3. Under **Offset Setting constant in:**, touch either the **Div** or **Volts** button.

Delay Control

As you change the timebase, this control allows you to either keep the horizontal offset indicator stationary (when **Div** is selected) or to have it move with the trigger point (when **Time** is selected). The advantage of selecting **Div** is that the trigger point will remain on the grid as you increase the timebase; whereas, if **Time** is selected, the trigger point could move off the grid.

Note: Regardless of whether you select **Time** or **Div**, the "Delay" shown in the timebase setup dialog always indicates time. However, when **Div** is selected for Delay In, the delay in time is scaled proportional to the change in timebase, thereby keeping the division on the grid constant.

1. In the menu bar touch **Utilities**; then touch **Preferences** in the drop-down menu.
2. Touch the **Acquisition** tab.
3. Under **Delay Setting constant in:**, touch either the **Div** or **Volts** button.

Trigger Counter

Checking the **Reset trigger counter before starting a new acquisition** checkbox clears the trigger counter each time the scope issues an arm acquisition command. This applies when you have set a trigger Holdoff condition in the Trigger dialog in either time or events:



The default condition of this control is off (unchecked).

Performance Optimization

You can set up the scope to optimize either calculating speed or display speed. If the display update rate is of primary concern to you, optimize for Display. If acquisition and analysis are more important, optimize for analysis. Optimizing for analysis can be useful when persistence or averaging is used, giving higher priority to waveform acquisition at the expense of display update rate.

The choices are presented as a spectrum with highest values at the extremes:



1. In the menu bar touch **Utilities**; then touch **Preferences** in the drop-down menu.
2. Touch one of the optimization icons.

E-mail

Before you can send e-mail from the scope, it must first be configured.

1. In the menu bar touch **Utilities**, then **Preference Setup...** in the drop-down menu.
2. Touch the **E-mail** tab.
3. Choose an e-mail server protocol: **MAPI** (Messaging Application Programming Interface) is the Microsoft interface specification that allows different messaging and workgroup applications (including e-mail, voice mail, and fax) to work through a single client, such as the Exchange client included with Windows 95 and Windows NT. MAPI uses the default Windows e-mail application (usually Outlook Express). **SMTP** (Simple Mail Transfer Protocol) is a TCP/IP protocol for sending messages from one computer to another through a network. This protocol is used on the Internet to route e-mail. In many cases no

account is needed.

4. If you chose MAPI, touch inside the **Originator Address (From:)** data entry field and use the pop-up keyboard to type in the instrument's e-mail address. Then touch inside the **Default Recipient Address (To:)** data entry field and use the pop-up keyboard to enter the recipient's e-mail address.
5. If you chose SMTP, touch inside the **SMTP Server** data entry field and use the pop-up keyboard to enter the name of your server. Touch inside the **Originator Address (From:)** data entry field and use the pop-up keyboard to type in the instrument's e-mail address. Then touch inside the **Default Recipient Address (To:)** data entry field and use the pop-up keyboard to enter the recipient's e-mail address.
6. You can send a test e-mail text message by touching the **Send Test Mail** button. The test message reads "Test mail from [name of scope's email address]."

Acquisition Status

For each general category of scope operation, you can view a summary of your setups. These dialogs are not accessible through the Utilities menu, but are instead accessed from the menu bar drop-down menus. The categories are as follows:

- Vertical -- select **Channels Status . . .** from drop-down menu
- Timebase -- select **Acquisition Status . . .** from drop-down menu
- Trigger -- select **Acquisition Status . . .** from drop-down menu
- Math -- select **Math Status . . .** from drop-down menu

In addition to these dialogs, summaries are also provided for XY setups, memory (M1-M4) setups, and time stamps for sequence mode sampling.

Service



This button provides access to service dialogs, which are for the sole use of LeCroy service personnel. A security code is required to gain access.

Show Windows Desktop

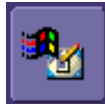

Touching the **Show Windows Desktop** button in the main "Utilities" dialog minimizes the instrument application to reveal the underlying desktop. To maximize the application, touch the appropriate shortcut icon:

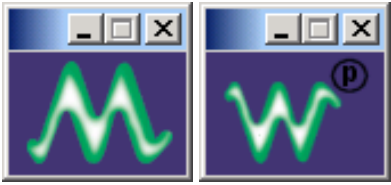

Touch Screen Calibration



Touching the **Touch-Screen Calibration** button starts the calibration procedure. During the procedure, you will be prompted to touch the center of a small cross in 5 key locations on the touch screen. Because sufficient accuracy cannot be achieved using your finger, use a stylus instead for this procedure. The calibration has a ten-second timeout in case no cross is touched.

To avoid parallax errors, be sure to place your line of sight directly in front of each cross before touching it.

CUSTOMIZATION

Customizing Your Instrument

The instrument provides powerful capability to add your own parameters, functions, display algorithms, or other routines to the scope user interface without having to leave the instrument application environment. You can customize the instrument to your needs by using the power of programs such as Excel™, Mathcad™, and MATLAB™, or by scripting in VBS. Whichever method you use, the results appear on the instrument's display together with the signals that you started with. This ability offers tremendous advantages in solving unique problems for a large range of applications, with comparatively little effort from you.

Introduction

Instrument customization provides these important capabilities:

- You can export data to programs, without leaving the instrument environment.
- You can get results back from those programs, and display them on the instrument, without leaving the instrument application environment.
- Once the result is returned, you can perform additional scope operations, such as measuring with cursors, applying parameters, or performing additional functions on the waveform, in exactly the same way as for a normal waveform.
- You can program the scope yourself.

The instrument does not just provide connectivity with data downloads to other programs. It provides true customizable interaction with these other programs, and allows you to truly customize the scope to do the exact job you want it to do. The advantages to this are many:

- You can use the standard processing power of the instrument to do most of your calculations
- You only need to write the function, parameter, display algorithm, etc. that specifically applies to your need and that the instrument doesn't contain.
- You can view the final result on the instrument display, and use all of the instrument's tools to understand the result.
- You can do additional processing on the result by applying either standard instrument parameters, functions, etc. to the returned result, or even more powerfully, adding chained customized functions. For example, you can do an Excel calculation on a result with a MATLAB function applied to it.

Solutions

Engineers do not buy equipment; they buy solutions. But what solutions can be reached from a set of instrument waveform data? In principle, anything that can be logically derived from those data, given the limitations of signal-to-noise ratio and processing time. Here are some examples of what can be done with a customized instrument:

- Changing the units of a grid to joules, newtons, amps, etc.

- Creating a new waveform by manipulating the data of one or two input waveforms
- Creating a new waveform without using any of the input data
- Creating a new parameter by manipulating the data of one or two input waveforms
- Changing a vertical scale or a horizontal scale from linear to non-linear

You don't have to use all the data from the input waveforms: you can select data from one or more segments, which need not be aligned in the two-input waveforms.

Examples

Example 1: Simple math functions using VBScript

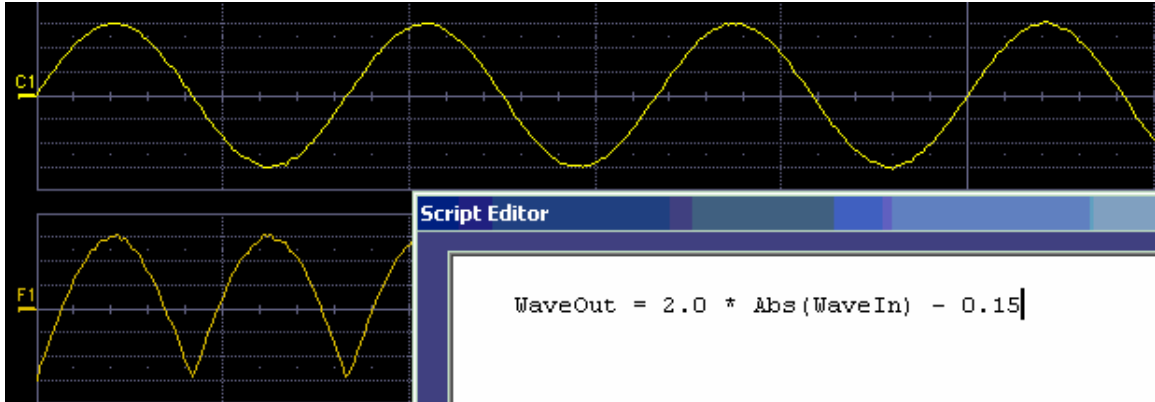

WaveOut is the waveform being returned to the instrument (F1 in this case). WaveIn is the input waveform (C1 in this case) You can see that the F1 result is displayed on the scope, and can be processed further.

Example 2: Another simple math function using VBScript

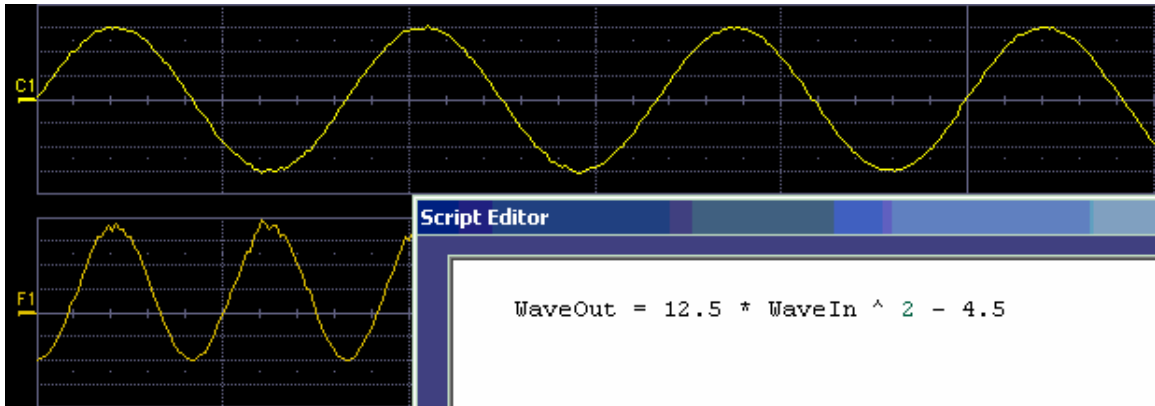

Example 3 below doesn't use the input data at all. The middle waveform (F2) is a "golden waveform", in this case a perfect sine (subject to 16-bit resolution), that was created using a VBScript. The lower trace (F3) is a subtraction of the acquired waveform (upper trace) and the

golden waveform. The subtraction (of course) contains all the noise, but it also shows the presence of a very small square wave signal.

Example 3

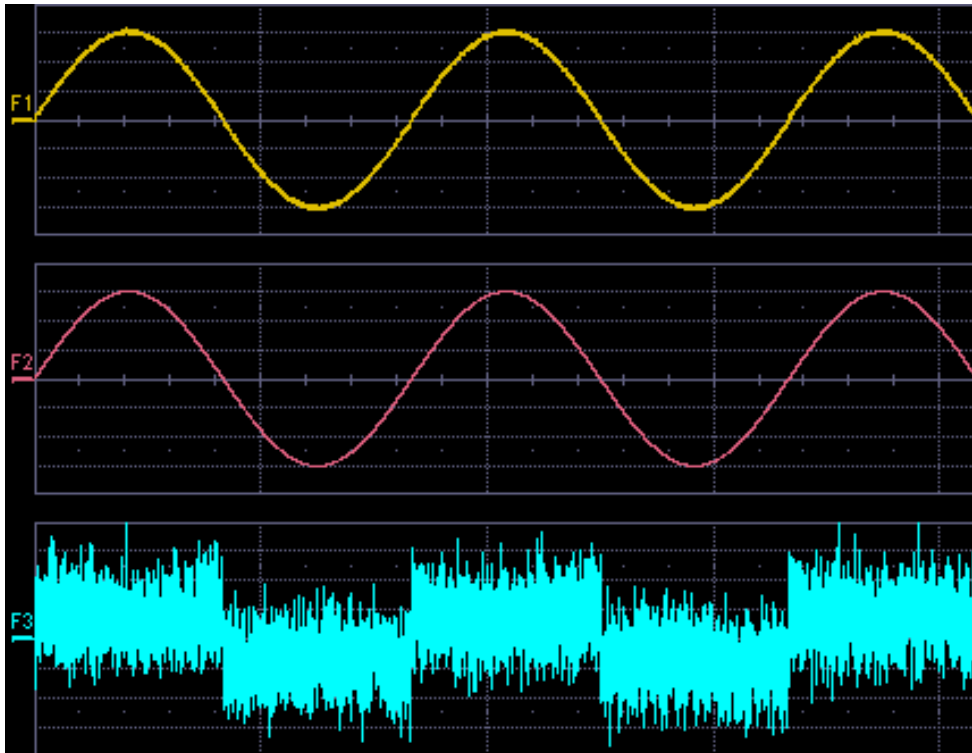

Here is the VBScript that produced the "golden sine" (F2 above):

```
Frequency = 3000000.0 ' Frequency of real data
SampleTime = InResult.HorizontalPerStep
Omega = 2.0 * 3.1416 * Frequency * SampleTime
Amplitude = 0.15 ' Amplitude of real data
  For K = 0 To LastPoint
    newDataArray(K) = Amplitude * Sin(Omega * K)
  Next
  OutResult.DataArray(True) = newDataArray ' Data in volts
```

OutResult.DataArray is the waveform returned to the scope and displayed on the scope as the F2 waveform.

Example 4

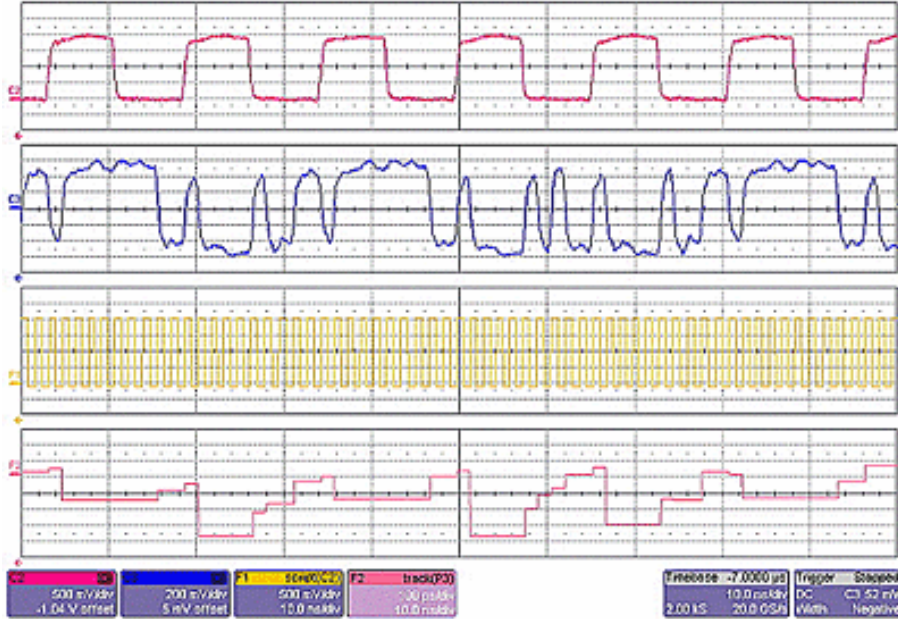

Example 4 is a measurement of DVI (Digital Video Interface) Data-Clock skew jitter measurement, using a VBScript to emulate the PLL.

In this example, a customer was not able to probe the desired clock signal. The only probing point available was the output differential clock signal (C2). However, that clock was a factor of 10 slower than the clock embedded in the data signal (C3). By using a VBScript to create a clock waveform of the appropriate frequency (waveform F1), the customer was able to display and measure data-clock skew using a LeCroy instrument function and parameter.

Example 5

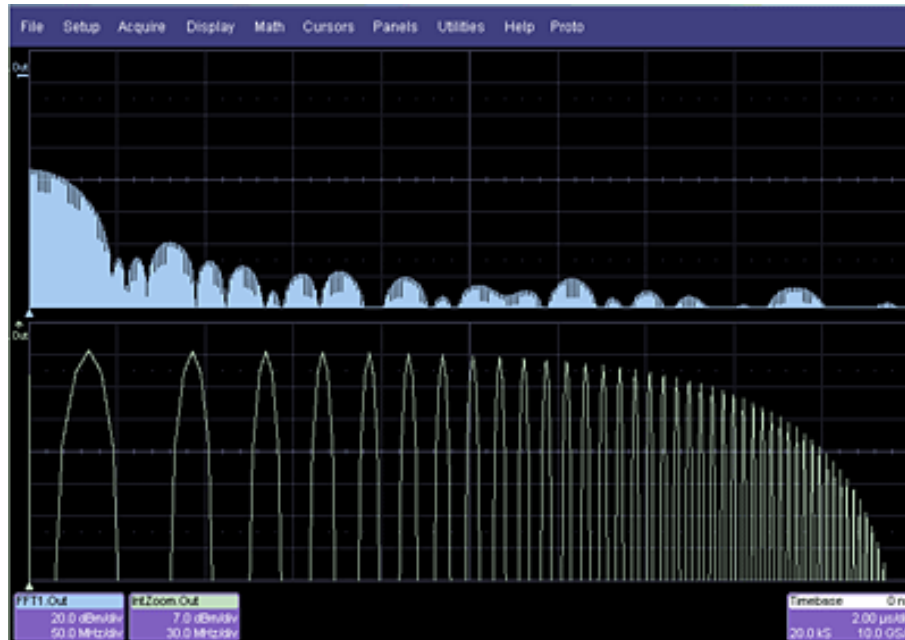

Next, a logarithmic vertical scale, for which the script can be found here. (Most scripts would be far simpler than this one.)

Frequency response curves are frequently drawn on a logarithmic scale. The upper trace is a frequency spectrum of a square wave after enhanced resolution has been applied. It was created using instrument functions. The lower trace is the first lobe of the FFT display. But with a logarithmic frequency scale. [Click here for the VBScript.](#)

In addition to VBScripting, MATLAB, Mathcad, or Excel can also be used to generate a result. The F1 trace (shown below in Example 6) was calculated in MATLAB ($F1=WformOut$) from C1 ($WformIn1$) and C2 ($WformIn2$). The same calculation could also be done in Excel by using a simple formula in a spreadsheet cell.

Example 6

The screenshot displays a software interface for a scope. On the left, three waveforms are shown: C1 (yellow sine wave), C2 (magenta square wave), and F1 (yellow sine wave). The main area is a 'MatLab Editor' window with the code: `WformOut = 1.9 * (WformIn1 + 0.5 * WformIn2);`. Below the editor is a 'MatLab Response' window. At the bottom of the editor area are buttons for 'Load Code', 'Save Code', and 'Close'. A control panel at the very bottom shows settings for C1, C2, and F1, and function keys F1 through F8.

Summary

The examples above illustrate only the capability to use VBScript and MATLAB. The instrument with the LeCroy XMAP software option allows you to use Excel, Mathcad, MATLAB, and VBScript in this manner. Of course, you will need to load Excel, Mathcad, or MATLAB in the scope (VBScript

does not require any additional software) to take advantage of the capability. You can think of these functions as "subroutines" of the instrument's main software, which take in waveform data and other variables like vertical scale and offset, and horizontal scale and offset. These functions then return a waveform or a parameter as required. In addition, you can view the calculated data directly in Excel, MATLAB, or Mathcad, if you desire.

What is Excel?

Excel is a program within Microsoft Office. With it you can place data in the cells of a spreadsheet, calculate other values from them, prepare charts of many kinds, use mathematical and statistical functions, and communicate with other programs in Office. From the instrument you can send data to Excel (where processing can take place) and return the results to the instrument.

What is Mathcad?

Mathcad is a software package from MathSoft. It provides an integrated environment for performing numerical calculations and solving equations, and communicating with other programs. Results can be presented in tabular or graphical form.

What is MATLAB?

MATLAB is a software package from MathWorks that provides an environment for work in computation and mathematics. An interactive language and graphics are provided.

What is VBS?

VBS is a programming language, but you don't write it in a special environment such as C++ or Visual Basic; you write it within your own application. In the instrument, a few clicks or button pushes will get you into an editing panel where you can write what you want. You cannot crash the scope, or in any other way interfere with its workings, because the system is completely protected.

A product of Microsoft and a subset of Visual Basic, VBS can be learned very quickly if you have some experience in any programming language. The VBS processing function can collect a number of useful variables from the scope, including waveform data and useful variables such as volts per division and time per division. The output from a script can be a waveform or a parameter, and you can choose your own values for variables such as volts per division.

The idea of a VBS function is that you start with an input waveform, operate on some or all of the values with a script, and show the result on a scope grid, like any other waveform.

VBS script customization is built into the instrument, so no additional programs need to be loaded to take advantage of this capability.

The following diagrams were made by changing a small part, in some cases just one line, of a standard VBS script. VBS is a well-known standard language, with excellent support documentation, and it is easy to use in several different environments.

The image displays three examples of X-Stream operator configurations, each consisting of a waveform plot (C1) and a script editor (F1).

Example 1: The waveform plot shows a sine wave (C1) and its absolute value (F1). The script editor contains the following code:

```
WaveOut = Sqr(Abs(WaveIn))-0.2
```

Example 2: The waveform plot shows a sine wave (C1) and a square wave (F1) that is high when the sine wave is positive and low when it is negative. The script editor contains the following code:

```
If WaveIn > 0 Then  
WaveOut = 0.5  
Else  
WaveOut = -0.5  
End If
```

Example 3: The waveform plot shows a sine wave (C1) and a square wave (F1) that is high only when the sine wave is above a certain threshold. The script editor contains the following code:

```
If WaveIn > 0.1 Then  
WaveOut = 0.5  
Else  
WaveOut = -0.5  
End If
```

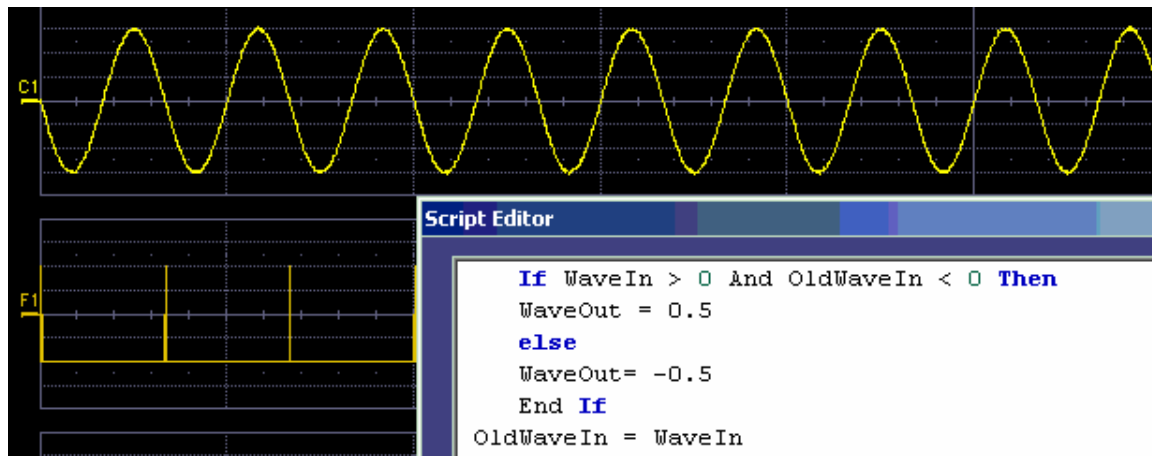

These examples are purely illustrative, but you can easily imagine that with a VBScript you can add value to the scope in a very short time. This gives you an instrument that does exactly what you want, time after time, by using your stored setups and scripts.

What can you do with a customized instrument?

If you require a result that can be derived logically from the input waveform, you can do it. Many calculations can be done with remarkably small scripts, but if you have no time for scripting, you can use one of the proprietary packages, such as Excel, MATLAB, or Mathcad, which offer immense processing power.

Scaling and Display

Scripting and programming allow a large variety of opportunities. You may, for example, be using transducers. If so, you can change the units of your waveforms, and write N (newtons), J (joules) and so on, and you can introduce scaling factors. If the transducers are non-linear, you can correct for that, too. You can also transform horizontal scales and vertical scales by manipulating the data. Logarithmic scales in amplitude and frequency are often required. Squaring and taking square roots are needed in certain applications. Here is a picture showing some graphs related to white noise, showing ways of detecting small deviations from the true distribution. The lower two graphs were generated and placed in one trace using a VBScript.

In the next example, four graphs are placed in one trace.

Golden Waveforms

This is a rich field for VBS. An example was given earlier. The only limits to the shapes that can be generated are the vertical resolution and the number of samples.

A practical example - DVI Data-Clock skew

The next example is a measurement of DVI Data-Clock skew jitter measurement, using a VBScript to emulate the PLL. A solution to a practical measurement problem was shown earlier.

These are just a few of the many solutions that can be created.

Number of Samples

The various math packages can process samples as follows:

Excel	65,535 samples
Mathcad	5 MS

The number of samples that MATLAB can process is determined by memory option, as follows:

Memory Length	System DRAM	Buffer Length
STD, S, M	256 MB	40 MB
L, VL	512 MB	200 MB
XL	1 GB	400 MB
XXL	2 GB	400 MB

Calling Excel From Your Instrument

Calling Excel Directly from the Instrument

Excel can be directly called from the instrument in two ways:

Using a function	F1 through Fx The number of math traces available depends on the software options loaded on your scope. See Specifications.	Excel returns a waveform
Using a parameter	P1 through Px The number of parameters available depends on the software options loaded on your scope. See Specifications.	Excel returns a parameter

In both cases, one call to Excel can use two separate waveforms as input.

Notes:

Excel has a calculation algorithm of 64,000 points (32,000 if you have created a chart in Excel). Therefore, make sure that your acquisition has less than this number of points if you are going to use an Excel calculation.

To use this capability, you must have the LeCroy XMAP software option and Excel loaded in your instrument. Select **Minimize** from the instrument's **File** menu to access the Excel program directly.

How to Select a Math Function Call

The Excel math function is selected from the **Math Operator** menu, where it appears in the **Custom** group.

How to Select a Parameter Function Call

The Excel Parameter function is selected from the **Select Measurement** menu, where it appears in the **Custom** group.

The Excel Control Dialog

Once you have invoked an Excel call, you will see a dialog at the right of the screen, allowing you to control the zoom, Excel properties, linking cells, and scale of the output trace from Excel:

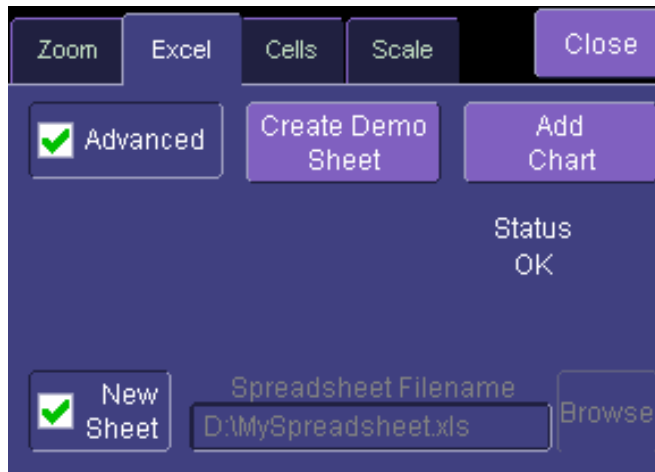

Entering a File Name

If you uncheck the **New Sheet** checkbox, you can enter the file name of an existing file.

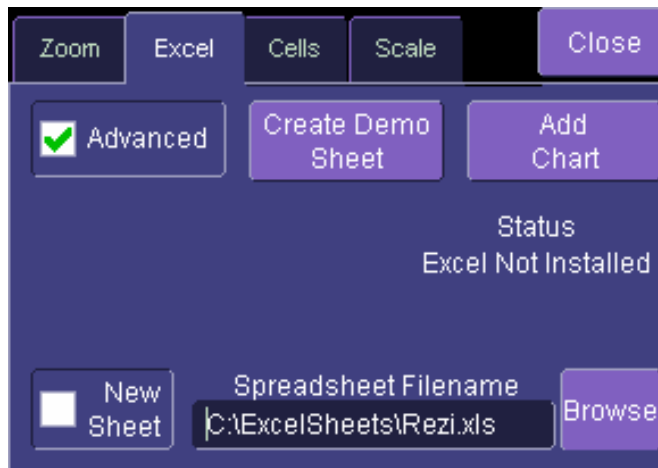

Create Demo Sheet Calls up a default Excel spreadsheet.

Add Chart Adds charts of your waveforms to Excel. You can go into Excel and create as many charts as you want.

Organizing Excel sheets

The **Cells** tab allows you to organize your Excel chart. When placing the components in the sheet, be careful to avoid over-writing needed information, especially when you are using multiple input waveforms. As depicted here, the instrument panel has been pasted over the Excel sheet:

	A	B	C	D	E	F	G	H	I	J	
1	Correlation between two noisy signals					Source1	Source2	Result			
2					NumSam	502	502	502			
3					VerUnits	V	V	V			
4					HorUnits	S	S	S			
5					HorStart	-1E-07	-1E-07	-1E-07			
6					HorStop	1E-07	1E-07	1E-07			
7					VerStart	-0.2	-0.2	-91279.6			
8					VerStop	0.2	0.2	88925.75			
9					HorPerSt	4E-10	4E-10	4E-10			
10					HorOffset	-1E-07	-1E-07	-1E-07			
11											
12											
13											
14											
15	0.071594	-0.12188	0.091712								
16	0.001404	-0.12031	0.062945								
17	0.101074	-0.12188	0.071709								
18	0.017084	-0.12344	0.0555								
19	0.067932	-0.125	0.050612								
20	0.039526	-0.12344	0.05493								
21	0.164331	-0.12344	0.04881								
22	0.046661	-0.12344	0.039346								
23	0.144519	-0.125	0.06103								
24	-0.01219	-0.125	0.022005								
25	0.110425	-0.12812	0.031164								
26	0.084753	-0.12656	0.03025								
27	0.066321	-0.12969	0.01925								
28	0.059198	-0.12656	-0.03082								
29	-0.05781	-0.12969	-0.02124								
30	-0.12086	-0.12969	-0.03324								
31	0.000317	-0.13125	-0.0595								

Zoom
Excel
Cells
Scale
Close

Cell References **Data** **Header**

<input checked="" type="checkbox"/> Include Headers	Enable	Source 1	Source 1
	<input checked="" type="checkbox"/>	A15	F2
	<input checked="" type="checkbox"/>	Source 2	Source 2
	<input checked="" type="checkbox"/>	B15	G2
<input type="button" value="Add Labels"/>		Output	Output
	<input checked="" type="checkbox"/>	C15	H2

There are three arrays of data for the three waveforms: up to two inputs and one output. There are corresponding small arrays of information about each trace.

Scale Setting the Vertical Scale

The vertical scale of the output waveform from Excel may be set in three ways:

Automatic	For each acquisition, the instrument fits the waveform into the grid.
Manual	For one acquisition, click Find Scale ; the instrument fits the current waveform into the grid.

	All subsequent acquisitions will use this scale until you make a change.
From Sheet	The scale is taken from the specified cells in the Excel sheet, H2 through H10 in the example above, where cell H2 was specified as the top of the data set, as depicted below.

E	F	G	H	I	J	K	L	M	N
	Source1	Source2	Result		Zoom	Excel	Cells	Scale	Close
NumSam	502	502	502		Scale Result <input type="button" value="Automatic"/> Use the min/max values of the processed waveform to scale. <input type="button" value="Manual"/> Auto-scale when Find Scale Pressed <input type="button" value="FromSheet"/> Retrieve output scales (Horiz and Vert) from spreadsheet. <input type="button" value="Find Scale"/>				
VerUnits	V	V	V						
HorUnits	S	S	S						
HorStart	-1E-07	-1E-07	-1E-07						
HorStop	1E-07	1E-07	1E-07						
VerStart	-0.2	-0.2	-91279.6						
VerStop	0.2	0.2	88925.75						
HorPerSt	4E-10	4E-10	4E-10						
HorOffset	-1E-07	-1E-07	-1E-07						

Trace Descriptors

The next figure explains the meanings of the descriptors for each trace.

C	D	E	F	G	H
two noisy signals		Source1	Source2	Result	
Samples in trace	NumSam	502	502	502	
Vertical units	VerUnits	V	V	V	
Horizontal units	HorUnits	S	S	S	
Left edge of grid	HorStart	-5E-08	-5E-08	-5E-08	
Right edge of grid	HorStop	1.5E-07	1.5E-07	1.5E-07	
Bottom of grid	VerStart	-0.2	-0.2	-0.32585	
Top of grid	VerStop	0.2	0.2	0.266995	
Time per sample	HorPerSt	4E-10	4E-10	4E-10	
Trigger position	HorOffset	-5E-08	-5E-08	-5E-08	

Multiple Inputs and Outputs

If you invoke two or more instrument parameter functions or waveform functions that call Excel, you will find that they all refer to the same spreadsheet by default. Thus, your spreadsheet can use the data from several waveforms, and you can derive many different combinations of output parameters and waveforms, including some of each, from your spreadsheet. You only have to be careful about the positioning of your cell ranges within the sheet so that no conflicts occur.

Because filling cells in the spreadsheet is a relatively slow process, all unwanted sources (inputs) should be left disabled (unchecked). For example, if you want one waveform and two parameters

derived from the data of three waveforms, you can have one function with both sources enabled, one with one source enabled, and one with no sources enabled. The alternative is to use one input in each function.

Simple Excel Example 1

In this example we use Excel to invert or negate a waveform. The first figure shows a part of the screen. The upper trace is the original signal. The lower is the result from Excel.

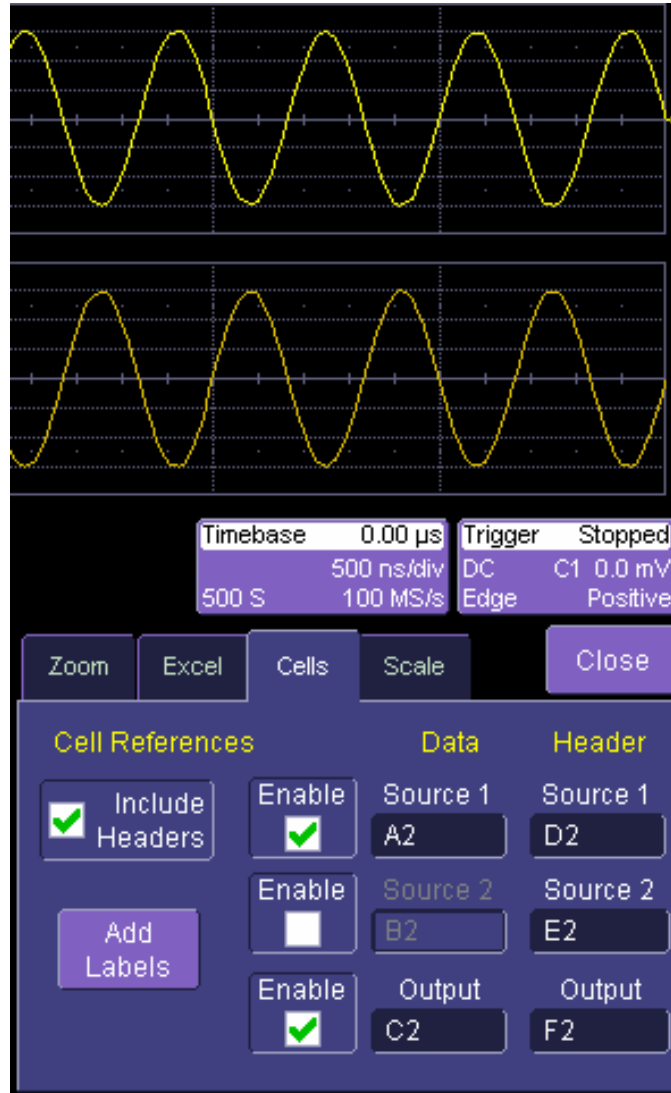

The dialog is the one that controls the location of the data in the Excel worksheet.

The input data are in columns A and B (though, only the first is used) and the output is in column C. All have been set to start at row 2, allowing space for a title in row 1.

Columns D, E and F contain the headers for the three waveforms. These are the set of numbers that provide the description of the scope settings, such as vertical scale and offset, and number of samples.

In this figure, the panel has been pasted onto the Excel sheet for comparison:

	A	B	C	D	E	F
1						
2	-0.00781		0.007813	502	502	502
3	-0.03281		0.032813	V	V	V
4	-0.06094		0.060938	S	S	S
5	-0.08438		0.084375	-2.5E-06	-2.5E-06	-2.5E-06
6	-0.10781		0.107813	2.5E-06	2.5E-06	2.5E-06
7	-0.125		0.125	-0.2	-0.2	-0.2125
8	-0.13906		0.139063	0.2	0.2	0.214063
9	-0.14688		0.146875	1E-08	1E-08	1E-08
10	-0.14688		0.146875	-2.5E-06	-2.5E-06	-2.5E-06
11	-0.14844		0.148438			
12	-0.13906		0.139063			
13	-0.12812		0.128125			
14	-0.11094		0.110937			
15	-0.09375		0.09375			
16	-0.06563		0.065625			
17	-0.04219		0.042188			
18	-0.01406		0.014063			
19	0.015625		-0.01563			
20	0.04375		-0.04375			
21	0.06875		-0.06875			
22	0.09375		-0.09375			
23	0.1125		-0.1125			
24	0.129688		-0.12969			
25	0.142188		-0.14219			
26	0.146875		-0.14688			
27	0.148438		-0.14844			
28	0.146875		-0.14688			
29	0.1375		-0.1375			
30	0.125		-0.125			
31	0.10625		-0.10625			
32	0.084375		-0.08438			

To get the output values in column C, we set C2 = -A2 and copy this formula down the column. This is the only action needed in Excel, and can be seen in the next figure:

	C2		=	=-A2			
	Name Box	B	C	D	E	F	
1							
2	-0.00781		0.007813	502	502	502	
3	-0.03281		0.032813	V	V	V	
4	-0.06094		0.060938	S	S	S	
5	-0.08438		0.084375	-2.5E-06	-2.5E-06	-2.5E-06	
6	-0.10781		0.107813	2.5E-06	2.5E-06	2.5E-06	
7	-0.125		0.125	-0.2	-0.2	-0.2125	
8	-0.13906		0.139063	0.2	0.2	0.214063	
9	-0.14688		0.146875	1E-08	1E-08	1E-08	
10	-0.14688		0.146875	-2.5E-06	-2.5E-06	-2.5E-06	
11	-0.14844		0.148438				
12	-0.13906		0.139063				
13	-0.12812		0.128125				
14	-0.11094		0.110937				
15	-0.09375		0.09375				
16	-0.06563		0.065625				
17	-0.04219		0.042188				
18	-0.01406		0.014063				
19	0.015625		-0.01563				
20	0.04375		-0.04375				

Simple Excel Example 2

In this example we use Excel to invert or negate a waveform. The first figure shows a part of the instrument screen. The upper trace (C1) is the original signal. The lower trace (F1) is the result calculated in Excel and displayed on the screen.

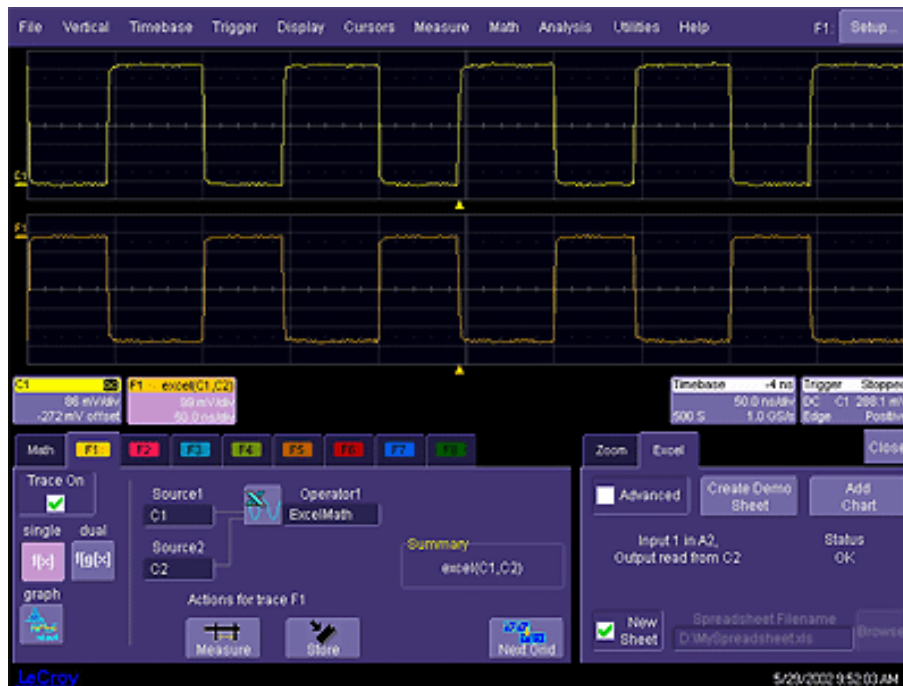

The input data is in columns A and B (though by default, only a single input/column is used), and the output is in column C. All have been set to start at row 2 (which allows for a header in row 1).

To create this waveform, you would simply do the following:

1. Ensure that your acquisition has no more than 64 kpts (the Excel calculation limit)
2. Choose a function, and select ExcelMath as **Operator1** for the function. Excel will open automatically in the background.

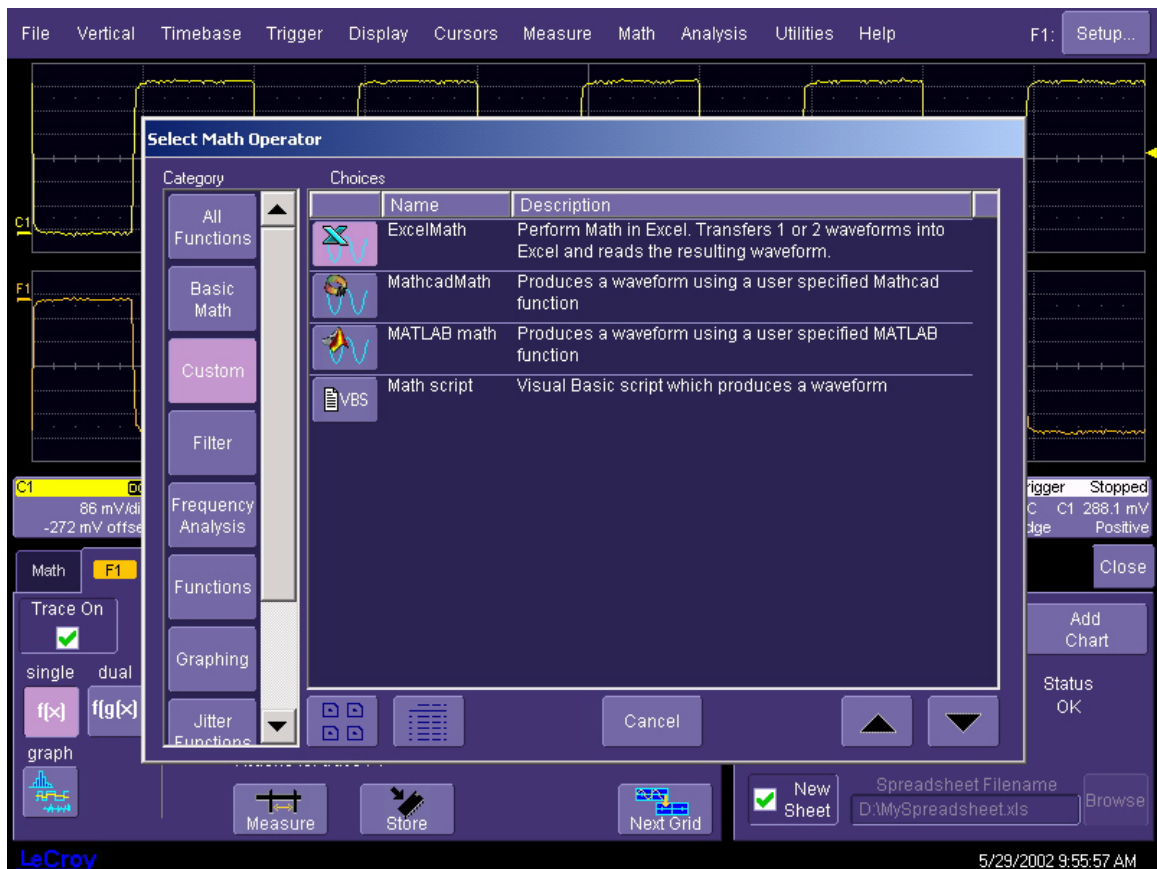

3. Choose File, Minimize from the menu bar to minimize the instrument display and open the Excel program.
4. Create your formula for each data point in column A (in this case, our formula for cell C2 is **-A2**, copied for the entire column), as shown here:

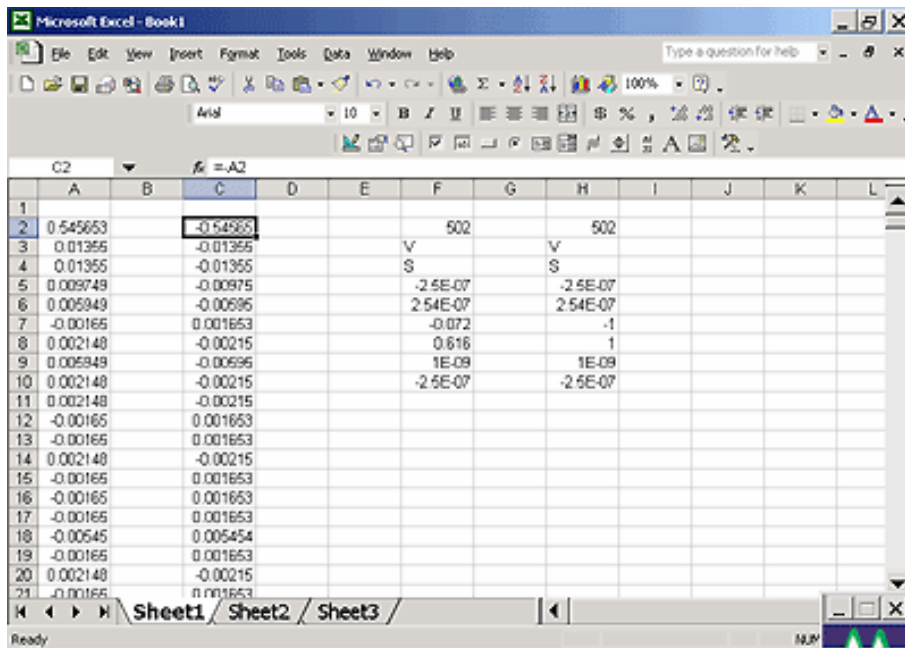

5. Retrigger the scope (if it is not currently triggering)
6. Return to the program

Note that the only action that was needed in Excel was to create the formula in column C for each data point in column A. The instrument automatically opens Excel, puts the waveform data in the correct columns, and returns the calculated data back to the display as the chosen F trace. This Excel-calculated trace can have further measurements or math calculations performed on it, if desired.

You can also create a chart of the data in Excel automatically and view the data there. Simply press the **Add Chart** button in the instrument's Excel dialog and a chart of the input (top chart) and Excel calculated output (bottom chart) will be automatically created in the spreadsheet. The chart will be updated automatically as the scope is triggered.

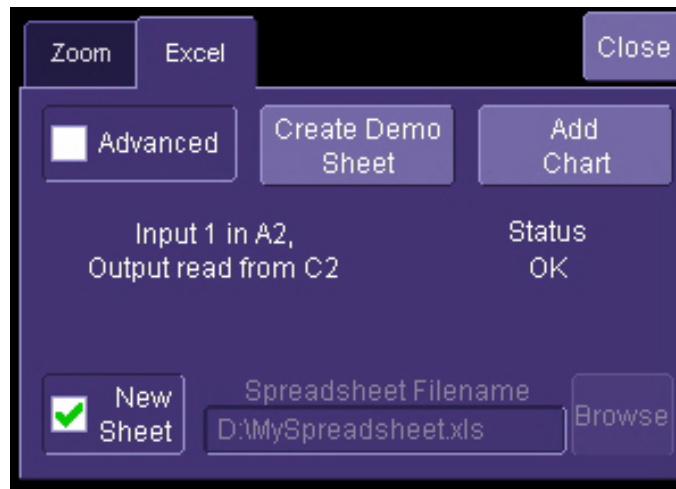
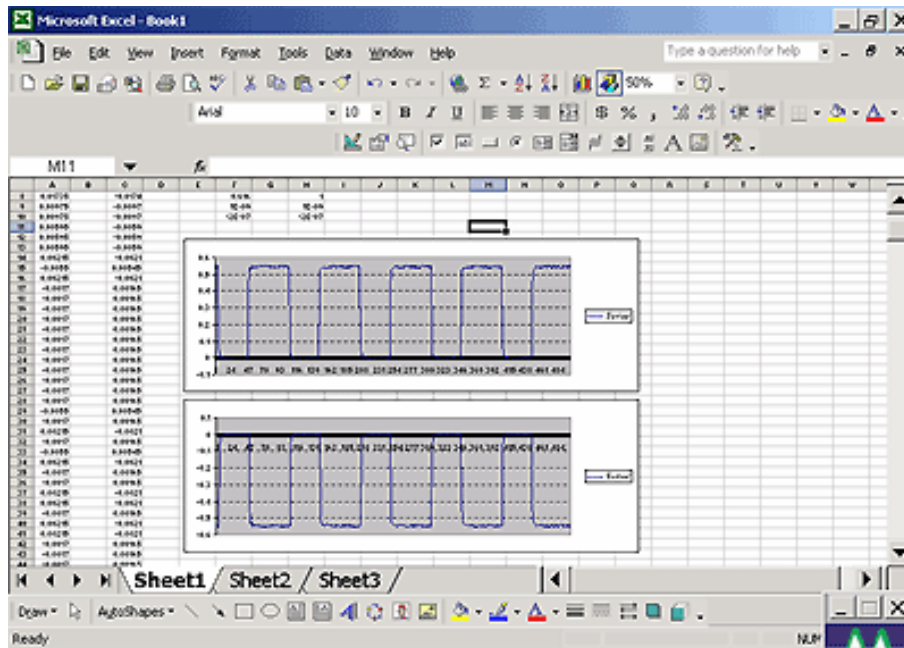

Exponential Decay Time Constant Excel Parameter (Excel Example 1)

This example calculates the time constant of an exponentially falling pulse, such as the light output of a phosphor.

The first figure shows a typical pulse, including pseudo-random noise, generated by a VBScript.

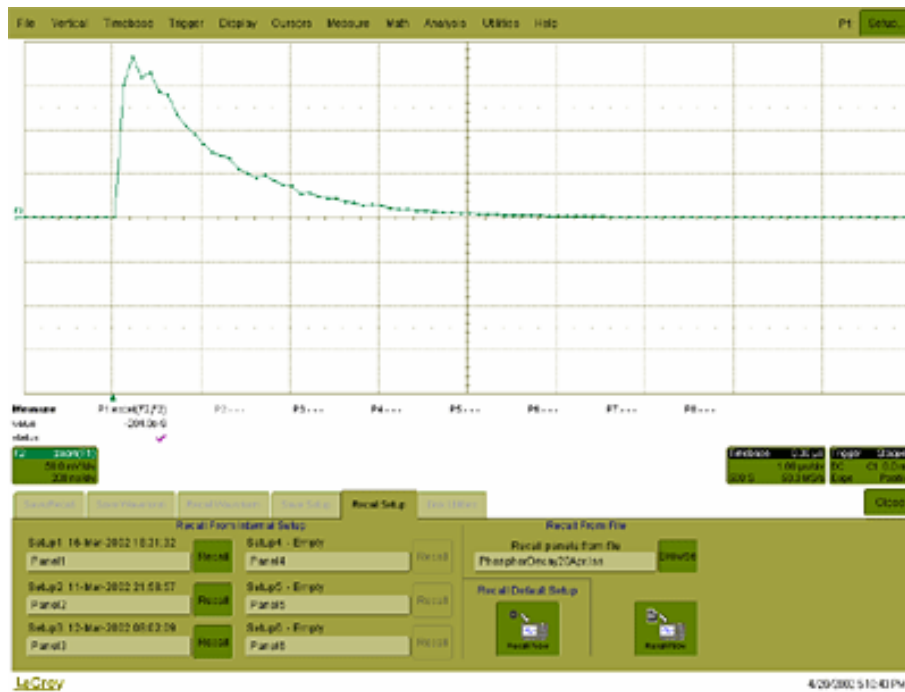

The pulse was generated by a formula of the form $e^{-(1-t/TC1)} * e^{-t/TC2}$, where TC1 and TC2 are time constants. The requirement is to measure the time constant TC2, using the portion of the trace where TC1 has negligible effect. This was done using Function F1, which is not a part of the measurement process.

For the actual measurement, Parameter P1 was set up as an Excel call. In Excel, the selected portion of the trace was converted to logarithms, and the Excel function SLOPE was used, as shown here:

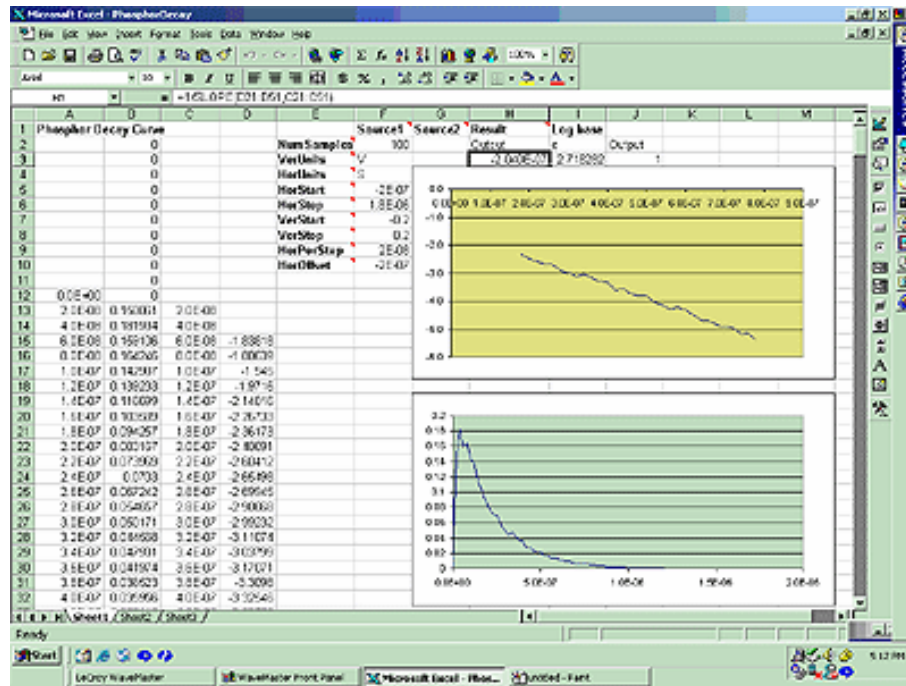

Here we see the input data in column B (with a time scale in A) created using the contents of cell F9, Horizontal Per Step. The logarithmic data are in column D, with the time scale repeated in C. The output appears in cell H3, using the formula `=1/SLOPE(D21:D51,C21:C51)`.

Gated Parameter Using Excel (Excel Example 2)

This example calculates a parameter of a waveform, in a region of interest defined by the leading edges of two pulses in a separate waveform.

This figure shows the instrument screen:

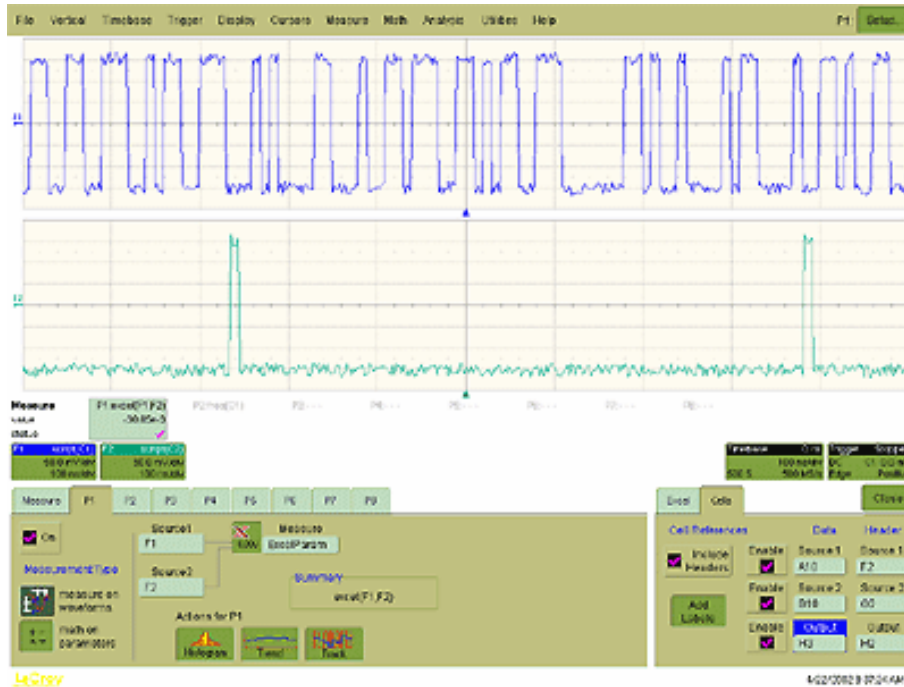

The traces were made using VBS scripts in functions F1 and F2, based on pseudo-random numbers to provide noise and varying pulse widths. Randomize Timer: Randomize Timer was used in both scripts to ensure that successive acquisitions produced different data. Script F1 generates pulses with widths that are multiples of a set clock period. F2 generates one pulse in the first half of the time window, and one pulse in the second half. Both pulses are constrained to coincide with the clock pulses of F1. F1 and F2 are used here only as simulations and are not part of the measurement process, which only uses P1.

The call to Excel is made through Parameter P1.

The next figure shows a part of the Excel workbook.

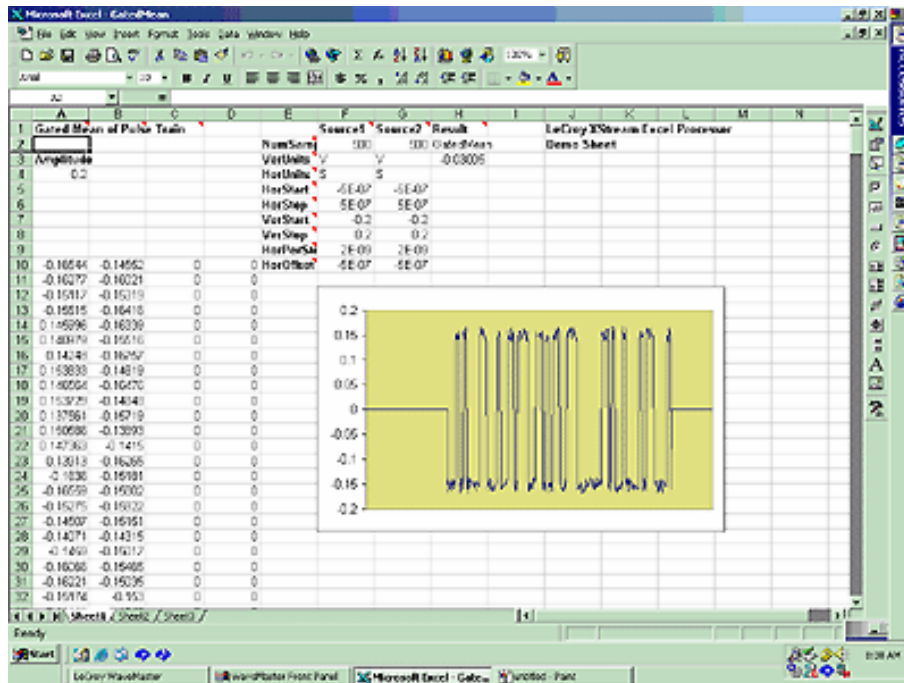

Here we see the gated waveform that has been created in Excel. The Mean parameter during the region of interest (ROI) is placed in cell H3.

How Does this Work?

The amplitude of the signal is about 0.3 volts, and the screen height is 0.4 volts, as derived from cells F7 and Fx. A threshold value for amplitude was calculated by placing $0.5 * (Fy - Fx)$ in cell A4.

Remember that in the instrument the sources were defined to be A10 and B10. This means that the first point on the waveform will be read into A10, and, since the waveform has 500 points, the last point will be read into A510. The same holds true for F2 and column B, since F2 is assigned as Source2, and data is defined to write into column B starting with cell B10.

To create the gating function in column C, the cell C10 was given the following formula:

$IF ((B10 - B9) > \$A\$4, 1 - C9, C9)$. This was copied down the column. Column D, the output column, is simply $A * C$.

The output was defined as cell H3.

The required mean in cell H3 is given by $SUM (D10 : D509) / SUM (C10 : C509)$, for a 500 point waveform.

Correlation Excel Waveform Function (Excel Example 3)

This example uses an Excel waveform function to examine the cross-correlation between two signals, which are both noisy sinusoidal segments. The correlation trace is, of necessity, shorter than the input traces.

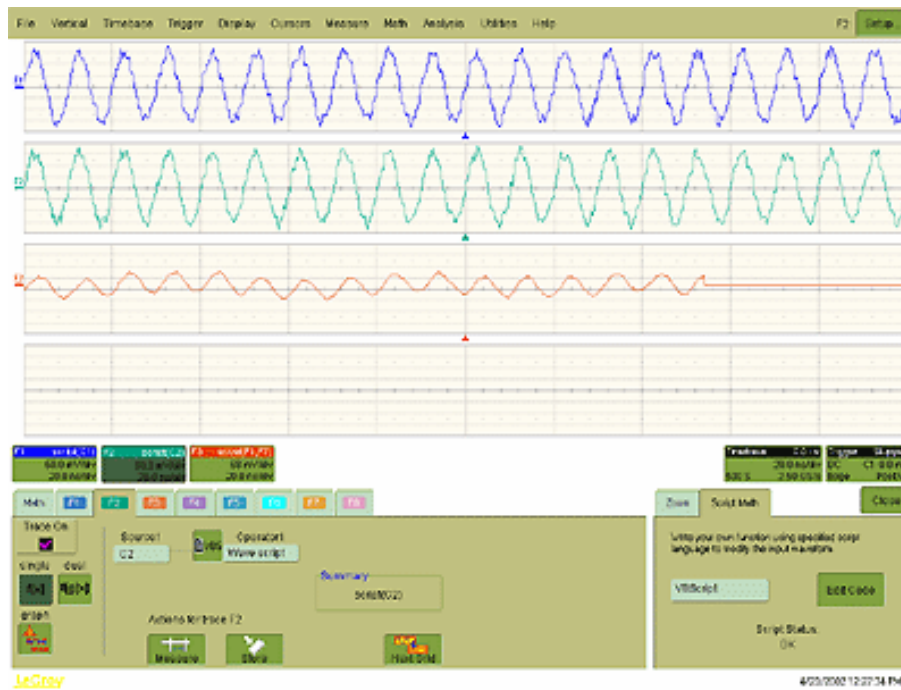

The noise was generated using pseudo-random numbers. Randomize Timer was included in the VBScript to ensure that the two traces differed, and that subsequent acquisitions differed. Functions F1 and F2 are included only to simulate signals, and are not part of the measurement process, which is performed by F3.

This example used the CORREL (Array1, Array2) function of Excel, as depicted below:

	A	B	C	D	E	F	G	H
1	Correlation between two noisy signals				Source1	Source2	Result	
2					NumSam	502	502	502
3					VerUnits	V	V	V
4					HorUnits	S	S	S
5					HorStart	-1E-07	-1E-07	-1E-07
6					HorStop	1E-07	1E-07	1E-07
7					VerStart	-0.2	-0.2	-0.28044
8					VerStop	0.2	0.2	0.236587
9					HorPerSte	4E-10	4E-10	4E-10
10					HorOffset	-1E-07	-1E-07	-1E-07
11								
12								
13								
14								
15	0.023621	-0.12031	-0.02207					
16	0.056354	-0.12188	-0.01667					
17	0.063599	-0.12031	-0.00469					

Multiple Traces on One Grid (Excel Example 4)

This example shows how you can place multiple traces in one picture, with only two operations in an Excel sheet. Depicted below is an example from an Excel spreadsheet.

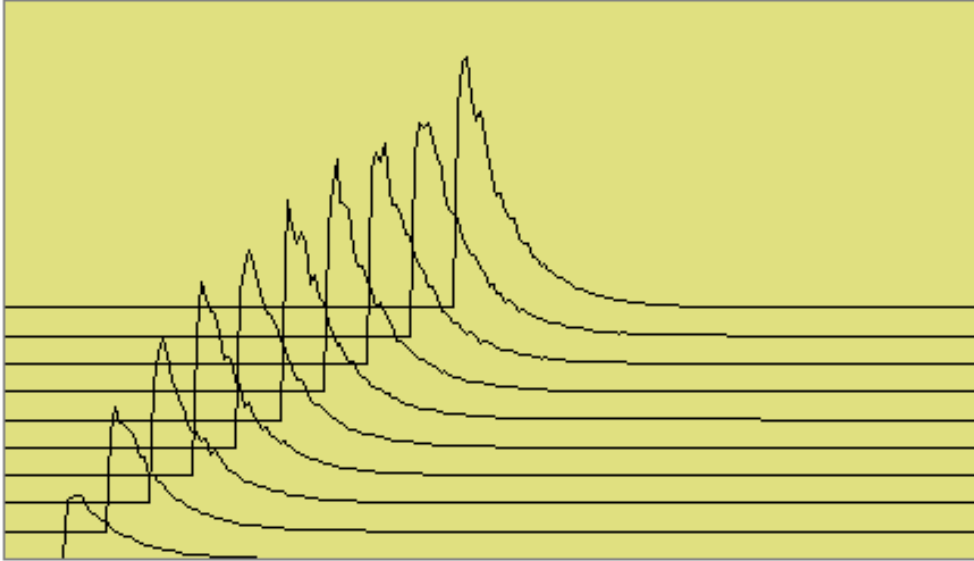

Here is an original instrument trace:

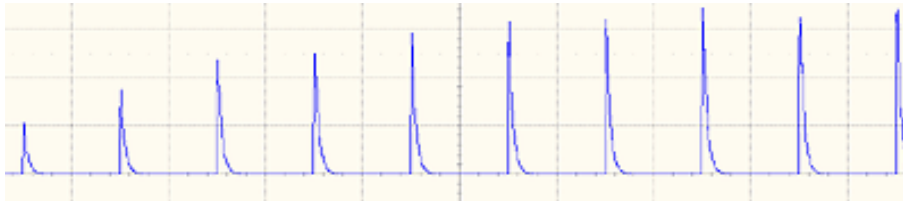

The method is very simple. First, the waveform is transferred to an Excel spreadsheet by means of an instrument Excel call. Second, two operations are needed in Excel: placing a simple formula in one cell, and copying that formula into a range of cells.

Depicted below is the required Excel formula:

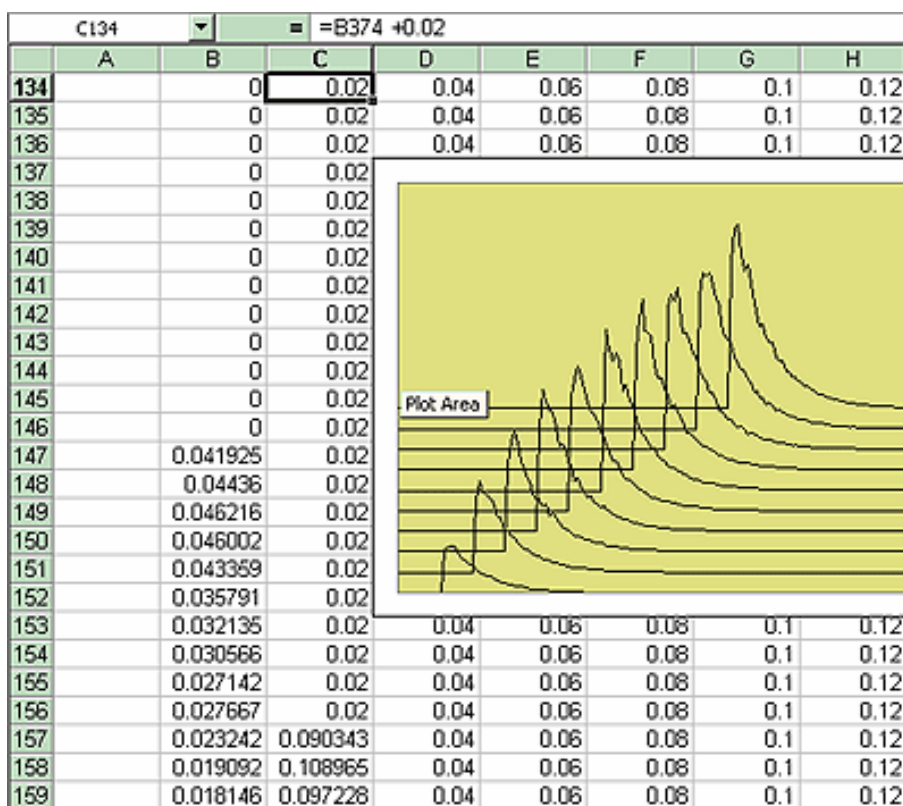

In fact, the simple expression $B374 + 0.02$ comprises several components. The original instrument trace is in column B, and the plot is required to start at cell B134. The traces repeat at intervals of 250 cells. Let us call this interval R . If we require a horizontal displacement D , then in cell CN we write $B(N + R - D)$. In this example D is 10. Finally we may want a vertical displacement V , and we write $B(N + R - D) + V$. In this example, V is 0.02. D and V can be zero if required, as depicted below. All that remains is to copy the formula to the required range of cells.

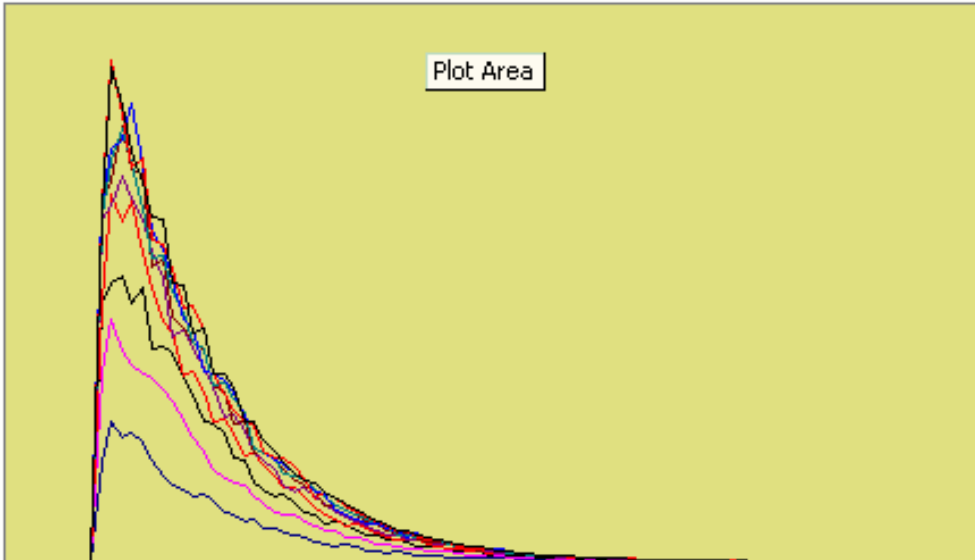
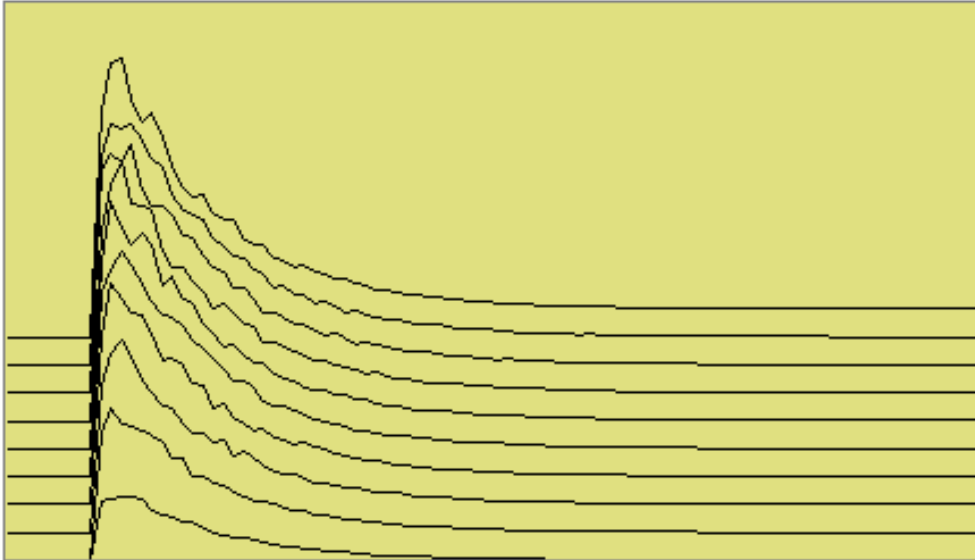

Using a Surface Plot (Excel Example 5)

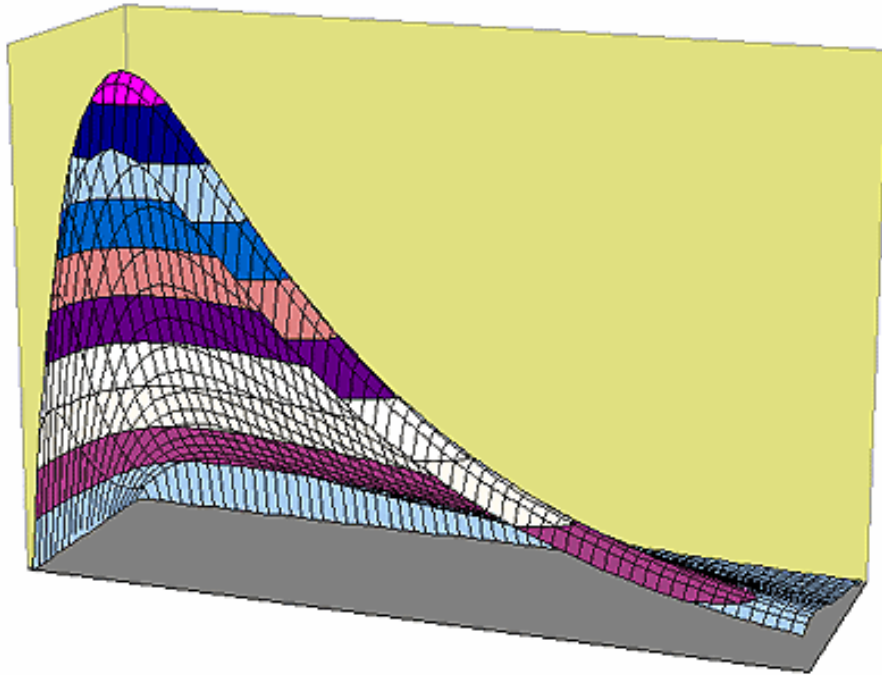
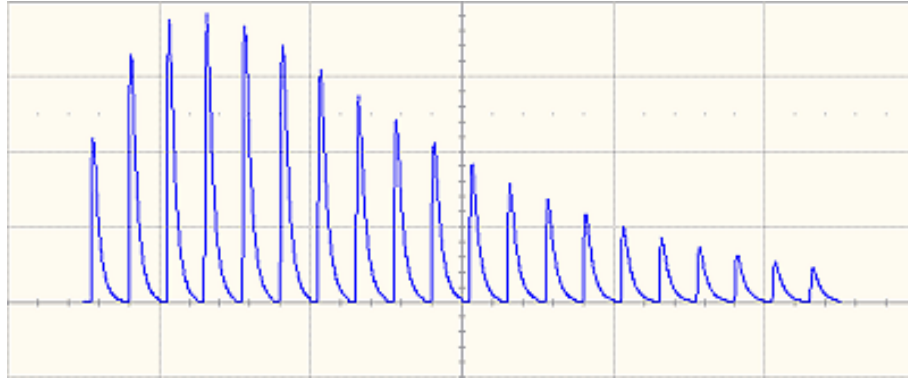

Writing VB Scripts

VBS scripting is one of the custom features of your instrument. Others include the ability to work with programs such as Excel, Mathcad and MATLAB.

Types of Scripts in VBS

The instrument's VBS provides two types of script.

- The Waveform Function script allows you to take the data from one or two traces and make a new trace whose values may depend on the values of the input trace.
- The Parameter Function script also takes in the data from one or two traces, but it only has one output. This output is the zeroth element in the output array. It appears as a parameter value on the instrument's screen. The remainder of the array is currently not used, and is not accessible.

Within both types of script, you can call Excel.

Loading and Saving VBScripts

From the editing panel you can save your script and you can load a previous one. Should you forget to save a script, please note that when you save your setup, it has your current scripts embedded in it. Therefore it is a good idea to save your setup frequently. It is worth saving the script separately as well, because it is saved in a suitable format for printing or off-line editing with Notepad. Note that in both these examples the input data are referred to as `InResult.DataArray`. You can also write `InResult1.DataArray` and `InResult2.DataArray`, which refer to the two input traces. `InResult.DataArray` always refers to input trace 1. These remarks hold for any script that you write.

Example Waveform Function Script: Square of a waveform

```
' Example script to produce a waveform
This example calculates the square of
the input waveform.
OutResult.Samples = InResult.Samples ' Visible trace length + 1
' Note that a trace of nominal length 1000 comprises data numbered from
' 0 to 1001. The 1001st point is not visible, so you
' normally use points 0 to 1000,
' giving 1001 points and 1000 intervals between points.
startData = 0
endData = OutResult.Samples
LastPoint = endData - 1 ' because the last point is invisible.
ReDim newArray(OutResult.Samples) ' to store the results
unscaledData = InResult.DataArray(False)
```

```
' InResult.DataArray(False) provides
' integer data from -32768 to 32767.
' InResult.DataArray(True) provides real data
' in the same physical unit as the vertical scale of the input trace.
ScaleFactor = 1.0 / 32768 ' to make the trace fill the screen.
```

```
    For i = 0 To LastPoint
        newArray(i) = ScaleFactor * (unscaledData(i)) ^ 2
    Next
```

```
OutResult.DataArray(False) = newArray ' signed long integer data output
```

Example Parameter Function Script: RMS of a waveform

```
' Example script to produce a parameter.
' This script calculates the root mean square
' of the input waveform.
' Note that a trace of nominal length 1000 has data from
' 0 to 1001. The 1001st point is not visible, so you
' normally use points 0 to 1000,
' giving 1001 points and 1000 intervals between points.
startData = 0
endData = InResult.Samples
LastPoint = endData - 1 ' because the last point is invisible.
ReDim newArray(InResult.Samples) ' to store the results
unscaledData = InResult.DataArray(True)
' InResult.DataArray(False) provides
' integer data from -32768 to 32767.
' InResult.DataArray(True) provides real data
' in the same unit as the vertical scale of the trace.
Total = 0
    For i = 0 To LastPoint
        Total = Total + (unscaledData(i)) ^ 2
    Next
NewArray(0) = Sqr (Total / (LastPoint + 1)) Place the result in the zeroth
```

element.

```
OutResult.ValueArray(True) = newArray ' integer data output
```

The default waveform function script: explanatory notes

InResult.Samples is the number of points in the incoming waveform.

InResult.DataArray(Boolean) (or InResult1.DataArray or InResult2.DataArray) is the array of input data. If the Boolean is True you get scaled real data in the units of the trace. If the Boolean is false you get unscaled integer data in the range -32768 to + 32767.

The value of InResult.Samples is the total number of data in a trace. It is two more than the nominal value given on the screen. The first point DataArray(0), coincides with the left edge of the screen, apart from the wobble caused by the trigger-to-sample clock difference. If the trace length is nominally 500, the right edge of the screen coincides with DataArray(500), which is the 501st point. The last point, number 502, is just off the right of the screen, and is never seen. That is why the loop in the script runs only to endData - 1.

OutResult.Samples is the number of data in the output trace, and is set to be the same as the number of data in the input trace. If you set the output length less than the input length, you get a shorter trace, the remainder being made of zeroes. If you try to set the output values to something illegal, you may find that a part of the trace retains the values from a previous acquisition.

If you try to set something outside the bounds of an array, or you make some other error, or something overflows, or you ask for something impossible, such as log(-13), the instrument tells you the line number, and the nature of the problem. Other types of error may not be given the correct line number, for example, if "Next" or "End If" is omitted, because VBS does not know where it should have been.

UnscaledData is simply a copy of the input data set.

ReDim newDataArray(OutResult.Samples) defines an array of data for use as a scratch pad. Dim is short for Dimension, which is used in Visual Basic to declare a variable (even if it only has one element, in which case you omit the size of the array).

InResult.DataArray(False) means that the data are signed integers in the range -32768 to 32767. False is a Boolean value applying to the property Scaled. Scaled data are specified in the units of the vertical scale, such as volts. You get these by putting "True" instead of "False". If you want to make a section of the output trace invisible, you simply set the data values to full scale or bigger, top or bottom.

You can start with the unscaled data (False) as input, and then set the output data to scaled data (True), and you can go from scaled to unscaled. Using scaled data, an overflow will make a picture like this:

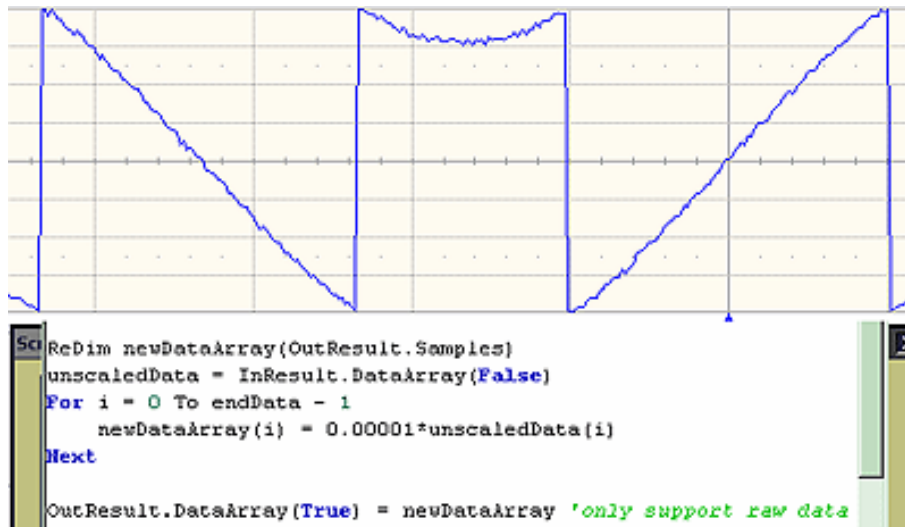

You can also start with True and convert to False, but in this case overflows will cause an error message.

Anything after a single quotation mark on a line will not be used by the instrument. This feature is intended for comments, for example

```

' This is a comment.
A = Amp * Sin(Omega * T) Calculate the output.
  
```

InResult.DataArray and OutResult.DataArray are only to be used as shown in the default scripts and in the example scripts: you cannot refer directly to individual elements of these arrays. You have to use your own arrays, in this example, unscaledData and newDataArray. You are not allowed to write statements like the following:

```

Y = InResult.DataArray (17)
OutResult.DataArray (257) = Z
  
```

Some parts of the default script must not be changed because they are a part of the interface. These are **highlighted** in the following script .

```

' TODO add your custom code here accessing OutResult and InResult objects
' Here's a small example that just inverts the waveform.
  
```

```

OutResult.Samples = InResult.Samples
startData = 0
endData = OutResult.Samples
newNumPoints = endData - startData
ReDim newDataArray (OutResult.Samples)
unscaledData = InResult.DataArray (False)
  
```

```
For i = 0 To endData - 1
    newDataArray (i) = - unscaledData (i)
Next
```

OutResult.DataArray (False) = newDataArray _' only support raw data

The four highlighted quantities are parts of the interface. The names must be retained. Furthermore, InResult.Samples and InResult.DataArray are inputs, and their values cannot be changed. OutResult.Samples and OutResult.DataArray are outputs, and can be changed, but not directly through their individual elements.

The default parameter function script: explanatory notes

The default parameter script is similar to the default waveform script, but there are subtle differences.

First, the size of the data array is the same as the nominal value: you cannot use or see the extra two points. So "500 points" means just that: 500 points.

Second, the output looks like an array, but only element zero is currently used. You must copy your parameter result into newValueArray(0). As with the arrays of the Waveform Script, you cannot refer directly to elements of the input and output arrays. You may not write something like

```
OutResult.ValueArray (0) = P.
```

Note that the unit of the parameter is displayed as the same as the vertical unit of the trace, even if you have squared the data, for example, unless you change the unit yourself.

The default parameter script is shown below.

```
' TODO add your custom code here accessing OutResult and InResult objects
' Here's a small example that just inverts the waveform
numParam = InResult.Samples
ReDim newValueArray(numParam)
scaledData = InResult.DataArray
    For i = 0 To numParam-1
        newValueArray(i) = -scaledData(i)_' Change this to do something useful.
    Next
```

```
OutResult.ValueArray = newValueArray 'only support raw data
```

Your parameter script should include something like this:

- A. Do calculation to obtain your parameter value from the input data array.
- B. newValueDataArray (0) = ParameterValue
- C. OutResult.ValueArray = newValueArray

You can test this script using setup MeanDemoScriptApr2.lss.

You can edit scripts using Notepad, but you will not get any notification of errors.

You are **not** allowed to write `OutResult.ValueArray(0) = MeanParameter`.

`InResult.DataArray` and `OutResult.DataArray` are only to be used as shown in the default scripts and in the example scripts. You cannot refer to, or modify, any individual element in these arrays.

Scripting with VBScript

Separators

The two separators in VBS are the colon `:` and the single quotation mark `'`.

Using the colon, you can place two or more statements on a line, for example:

```
XMin = 0.0 : XMax = 800.0 : YMin = 0.0 : YMax = 600.0
```

There is also an implied separator whenever a new line is begun.

Using the quotation mark you can signify that the remainder of the line is a comment: non-executable material that is usually used to clarify the workings of the script. For example:

```
RMSMax = 32767 / Sqr (2)      ' RMS of the largest sinusoid that can  
be  
                               ' fitted into the screen in unscaled mode.
```

To continue a comment on to another line, another quotation mark is required on the new line.

Variable Types

VBS supports the following variable types:

Integer	signed 16 bit value in the range -32768 to 32767
Long	signed 32 bit value in the range -2^{31} to $+2^{31} - 1$
Single	real number or floating point number
Double	real number or floating point number
Boolean	Boolean or logical value
String	string of characters

When making comparisons using real numbers, beware of testing for equality, because of rounding errors. It may be better to apply a tolerance band. For Boolean, integers and strings, equality is valid.

You can use variables in VBS without declaring the type. The context may force an implicit type assignment. For example, if the result of a calculation is of a different type from the defined type, the type may be changed. Always set out calculations in such a way that type changes will not affect the final result in an undesirable or unpredictable way. If you want to change the type of a variable or a result, use a conversion function that will show others what you intend to happen. The conversion functions are `CDbl`, `CInt`, `CLng`, `CSng`, `CStr`.

Variable Names

Upper and lower case have no significance in VBS, either in variable names or in keywords (the names reserved by the system), but it is a good idea to be consistent about the spelling of a variable name to avoid confusion. At least 36 characters may be used in a variable name. These can include any combination of alphabetic and numeric characters, and the underscore character. No other punctuation character may be used in a variable name.

Do not use any of the following characters in a variable name:

! @ & \$ # ? , * . { } () [] = + - ^ % / ~ < > : ;

Just use alphanumerics and underscore, for example: Example_Name

If you have to introduce constants, give them sensible names, just like variables. For example, do not write:

```
_If RMS < 23169 Then OutputY = Y
```

Its meaning may not be obvious to someone else.

It is better to write something like this:

```
FullScale = 32767
RootTwo = Sqr (2.0)
MaxRMS = FullScale / RootTwo
. . . . .
If RMS < MaxRMS Then . . . . .
```

But to keep your scripts fast, leave definitions like this outside your loops.

General usage

Note that white space has no effect, so you can introduce spaces for clarity, except of course within variable names, function names and other keywords. Indenting control statements can be a great help in understanding a program. For example:

```
For K = Kstart To Kstop
X = K * Sqr (3)
  For N = NStart To Nstop
    Y = N * N
      If Y < FullScale Then
        . . . . .
        . . . . .
      End If    ' End of main calculation
    Next      ' End of N loop
```



```
Next ' End of K loop
```

If a section becomes very long, you could provide the end with a comment, to show where it comes from.

Arithmetic Operators

As with most other languages, the arithmetic operators are used as follows:

<code>^</code>	Exponentiation	$A \wedge B = A^B = A$ raised to the power B
<code>/</code>	Division	$A / B = A$ divided by B
<code>\</code>	Integer division	$A \setminus B = A$ divided by B, truncated to next integer below
<code>*</code>	Multiplication	$A * B = A$ multiplied by B
<code>+</code>	Addition	$A + B = B$ added to A
<code>-</code>	Subtraction	$A - B = B$ subtracted from A

Notes:

If there is any possibility that you will be taking the exponent of a negative number, make sure to trap any possible errors arising from such operations as trying to take the square root of a negative number. Logs of negative numbers are forbidden also.

If there is any possibility that you will be dividing by zero, make sure to trap this.

There are two ways of dealing with these types of problem. One is to prevent it happening by making suitable tests before the calculation is performed. The other is to let it happen, and use an error handling routine. This will be discussed later.

Normally in VBScript you will know the range of the data, since all the incoming data are, by definition, integer (unscaled data) or real (scaled data), and they must fit into the screen of the instrument.

Results of Calculations

Sometimes you may see a statement like this:

```
A = A * A * (Cos (A) + Sin (A) )
```

The program takes the quantity represented by A and performs all of the following operations, using that original value:

- Multiply A by itself.
- Calculate the cosine of A.
- Calculate the sine of A.
- Add the cosine and the sine together.
- Multiply that result by the square of A.

At this point, the quantity represented by A has not been changed. Only at the end of the calculation is the final value placed in the memory location labeled A.

Note that you can write more than one statement on a line, separated by colons, like this

```
A = B * Cos (34 * Theta) * Sin (55 * Theta) : B = A * A + Z * Z
```

Order of Calculations

Operations are performed in the following order:

1. Contents of brackets
2. Exponentiation
3. Division and multiplication
4. Addition and subtraction

If there is any doubt as to how the calculation will be done, use brackets. These will also make the order of the calculations clear to any reader of the program, which is desirable if you are to give it to a customer, who will want to know what was intended.

Here are some examples of the uses of brackets:

Brackets are worked out before any other operations are performed.

Use brackets to force the result you want, and also to clarify a calculation.

```
A 1 1 1 1 1 1 1 1 255 0 1 0 1 1 0 1 0 90 (B OR C) AND (D OR E)
B 1 1 1 1 0 0 0 0 240 0 0 0 0 0 0 0 0 B OR (C AND D) OR E
C 1 0 1 0 1 0 1 0 130 1 1 1 1 1 0 1 0 250 B OR (C AND (D OR E))
D 0 1 0 1 0 1 0 1 85 0 1 0 1 1 1 1 1 95 ((B OR C) AND D) OR E
E 0 0 0 0 1 1 1 1 15
F 0 0 0 0 0 0 0 0 0
```

A 7	315	$A * B * (C / D) * E * F$
B 6	8.75	$A * B * C / (D * E * F)$
C 5	35	$A * B * (C / (D * E)) * F$
D 4		
E 3		
F 2		

Check these results to see whether any errors, deliberate or otherwise, have been introduced.

These results are from file Brackets.Xls. You can make a copy of that file in order to experiment with different combinations of brackets.

VBS Controls

Do Do Do

```
Loop          Loop Until . . . .   Loop While
Do Until      Do While              Exit Do
. . . .      . . . .
Loop          Loop
For . . . Next                Exit For
```

GoTo__ **This is not allowed in instrument VBS.**

```
If . . . . Then . . . . _' On one line__
```

```
If . . . Then
```

```
ElseIf . . . Then
```

```
End If
```

```
If . . . Then . . . End If__
```

```
If . . . Then . . . Else . . . End If
```

```
Select Case
```

```
. . . .
```

```
End Select
```

```
While
```

```
. . . .
```

```
Wend
```

Choose the construction that best satisfies the requirements of speed and clarity.

The construction GoTo LabelledStatement is available in many languages, including VBA, but not in VBS. **GOTO** is not allowed in VBS.

IF . . . Then . . . Else . . . End If

A very simple example:

```
    If A >= 0 Then B = Sqr (A) 'Take the square root of A if A is not negative.
```

```
    If A + B < C + D Then E = F : G = H_ 'No End Is needed if all on one line.
```

If you need to perform a longer procedure, make this construction:

```
    If A >= 0 Then
```

```
        B = Sqr (A)
```

```
        C = 32766 * Sin ( TwoPi * B / PeriodOfSinusoid)
```

```
    End If      ' End If is needed to terminate the construction.
```

The If statement is very often used with the following Boolean expressions:

A > B	A is greater than B
A >= B	A is greater than B or equal to B
A = B	A is equal to B
A < B	A is less than B
A <= B	A is less than B or equal to B
A <> B	A is not equal to B

These statements are not like the usual program statements, such as $A = B$. These statements are Boolean (logic) statements, which can take the values True or False. You may even see things like "If A Then B", which means that if A is True, B gets done.

In the first example, if A is negative, we might want to write something like this:

```
If A >= 0 Then
  B = Sqr (A)
Else
  B = 0
End If
```

and in fact you can make some very complex constructions using If, as in the examples below:

```
If A < 0 Then
  If A < - 1 Then
    Z = 17
  Else_
    Z = 31
  End If
Else_
  If A > 3 Then
    Z = 63
  Else
    Z = 127
  End If
End If
If A > 0 Then
  If B > 0 Then
```

```
Z = Y
End If
End If
```

This is equivalent to:

```
If ( (A > 0) And (B > 0) ) Then
Z = Y
End If
```

Summary of If Then Else

```
If Boolean Then AnyVBScriptingOnOneLine
If Boolean Then
AnyVBScripting
End If
If Boolean Then
AnyVBScripting
Else
AnyOtherVBScripting
End If
```

If you write a list like this, all the Booleans will be evaluated, whether you want that or not:

```
If A > 9 Then VBScripting1
If A > 7 Then VBScripting2
If A > 6 Then VBScripting3
If A > 4 Then VBScripting4
If A > 3 Then VBScripting5
If A > 1 Then VBScripting6
```

Be very careful when testing for equality. There will be no trouble with Integers, Long Integers, and Strings, but Real numbers are different. Because they have so many significant digits, values that should be equal, may differ minutely after a computation. It is safer with Real numbers to test using a tolerance band.

File for this example: IfThenElse.xls

If you find that you are building up a rather complicated set of Ifs, you might want to consider the Select Case construction.

Select Case

This is a very powerful construction, which is also easy to understand when written out. It is best for

Integers and Strings, where exact values are always obtained. Here is a simple example:

```
Select Case K
    Case 7 : Y = 6 : Z = 3
    Case 7 : Y = Sqr ( Sin ( A ) ) : Z = Sqr ( Cos ( A ) )
    Case N : Z = Y + X
    Case Else :
End Select
```

Case N assumes that the value of N has already been set. Case Else is included to cover other cases, whether foreseen or not. It should always be included.

You can also provide lists of values.

```
Select Case K
    Case 1, 2, 3, 5, 8, 13 : Y = 55 : Z = 89
    Case 4, 9, 16, 25, 36 : Y = Sqr ( Sin ( A ) ) : Z = Sqr ( Cos ( A ) )
    Case 7, 15, 31, 63, 127 : Z = Y + X
    Case Else : Z = 3
End Select
```

Case N assumes that the value of N has already been set. Case Else is included to cover other cases, whether foreseen or not. It should always be included.

This is very much neater than a string of Ifs and Elses, but remember: you cannot use Select Case unless you are sure of exact equality, which allows you to compare integers and strings only. You cannot put `Case > 5`, for example. File for this example: `SelectCase.Xls`

Summary of Select Case . . . End Select

```
SelectCase VariableName
    Case Alist : VBScriptingA
    Case Blist : VBScriptingB
    . . . .
    Case Else : VBScriptingElse_ VBScriptingElse can be empty.
End Select
```

Do . . . Loop

This construction is useful when you do not know at programming time how many times the loop will be executed. Here are some examples:

```
Do
AnyVBSCalculation
```

```
Loop Until D > Pi
Do Until Z < Y
AnyVBSCalculation
Loop
Do
AnyVBSCalculation
Loop While D <= Pi
Do While Y >=Z
AnyVBSCalculation
Loop
```

These constructions enable you to make the test before or after the calculation. If before, the calculation might not be done even one time, if the condition for terminating were already true. With the condition at the end, the calculation is done at least one time.

Sometimes you might want to exit the loop from somewhere inside: for example, if some kind of problem is looming, such as the logarithm of a negative number.

For this case, you can use **If . . . Then Exit Do**.

To make a pause of 10 seconds you can write:

```
NewTime = Timer + 10.0
Do Loop Until Timer >= NewTime
```

where Timer is a clock function in the PC, which has a resolution of one second.

Example file for these constructions: DoLoops.Xls

While . . . Wend

This is similar to Do While . . . Loop. You can write things like:

```
While ( (A > 2) And (C < 92677663) )
AnyVBCalculation
Wend
```

For . . . Next

Sometimes you know, or you think you know, the number of times that you want to do a job. For this case a For loop is ideal, especially when you have an array of numbers to work with.

Examples:

```
For K = 0 To Total
HistogramBin (K) = 0
```

```
Next
```

```
Omega = TwoPi / Period
```

```
For N = 0 To Period
```

```
Y (N) = A * Sin (Omega * N)
```

```
Next
```

Be careful about changing the counting variable in any loop. You can do this to terminate the loop early (but **Exit For** is better), but you could also prevent it from terminating at all.

For emergency exit, you can use **Exit For**. For example:

```
For K = 0 To Total
```

```
    If HistogramBin(K) = 0 Then Exit For
```

```
AnyVBScripting
```

```
Next
```

It is possible to make a For loop with steps greater than 1, as in the following example in which K takes the values 3, 7, 11, 15, 83.

```
For K = 3 To 82 Step 4
```

```
AnyVBScripting
```

```
Next K
```

You may place loops inside one another (nested loops), but they must all use different control variables. Example:

```
For K = 0 To N
```

```
    VBScriptingK
```

```
        For L = - 7 To 17
```

```
            VBScriptingL
```

```
                For M = S To T
```

```
                    VBScriptingM
```

```
                Next
```

```
            Next
```

```
        Next
```

VBS Keywords and Functions

The ones in italics do not apply to the instrument.

+	Add two values or concatenate two strings.
-	Subtract two values.
*	Multiply two values.
/	Divide two values.
\	Divide two values to obtain an integer result
Abs	Make absolute value.
Asc	Make ASCII value of a character.
Atn	Make \tan^{-1} of a value. Result in range from $-\pi / 2$ to $+\pi / 2$ radians.
Cdbl	Convert a value to double precision floating point.
Chr	Create a character from an integer in range 0 to 255.
Cint	Convert a value to nearest integer in the range -32768 to +32767
Clng	Convert a value to nearest long integer in the range -2^{31} to $+2^{31} - 1$.
<i>Close</i>	<i>Close a file.</i>
Cos	Make the cosine of an angle expressed in radians.
Csng	Convert a number to single precision floating point.
Cstr	Convert a variable to a string.
Exp	Raise e to the power of the input.
<i>Get</i>	<i>Get a value from a file.</i>
<i>Input</i>	<i>Get some ASCII data from a file.</i>
Instr	Find the position of a string in a longer string.
Int	Convert to nearest integer below the input value.
Left	Take some characters at the left end of a string.

Log	Take the natural logarithm of a positive value.
Ltrim	Remove spaces at the left end of a string.
Mid	Take or insert some characters in a string.
Mod	Take the modulus of a value in terms of another value.
On Error	Take some action if an error occurs.
<i>Open</i>	<i>Open a file.</i>
<i>Print</i>	<i>Send some ASCII data to a file.</i>
<i>Put</i>	<i>Send some data to a file.</i>
Randomize	Randomize Timer re-seeds the pseudo-random number generator.
<i>Read</i>	<i>Read from a file.</i>
Right	Take some characters at the right end of a string.
Rnd	Make a random real number in the range from 0.0 to 1.0
Rtrim	Remove spaces from right hand end of a string.
Sin	Make the sine of an angle expressed in radians.
Sqr	Make the square root of a positive number.
Str	Make a string from a numerical value.
Timer	Time since midnight in seconds, with a resolution of one second.
Trim	Remove leading and trailing spaces from a string.
<i>Val</i>	<i>Get the ASCII value of a string beginning with numerical characters.</i>

Other VBS Words

Const	Define a constant value.
Dim	Dimension a variable.
Redim	Dimension a variable again.
Boolean	Boolean variable
Double	Double precision real variable.

Integer	Integer in the range -32768 to + 32767
Long	Long integer in the range -2^{31} to $+ 2^{31} - 1$
Single	Single precision real variable
String	String variable
And	Logical AND
Or	Logical OR

To make a bit-by-bit comparison, logical constructions can be used with variables, as in A and B, or with tests such as If A > B Then . . .

Functions

These are mainly of the form C = F (A), where A is the argument, or input to the function.

Abs	Abs (A) calculates the absolute value of an integer or a real number, so the result is always positive or zero. A can be any number in the range of the VB system.
Atn	Atn (A) calculates the angle of which A is the tangent. Because infinitely many angles can have the same tangent, the output of Atn always lies in the range minus $\pi / 2$ to plus $\pi / 2$. The input can be any positive or negative value in the range of the VB system.
CDbl	CDbl (A) calculates a double precision real variable, equal to A.
CInt	CInt (A) calculates the integer value nearest to A, which can be any acceptable VBS number. CInt (-7.4) = -7. Integers are signed 16-bit values in the range -32767 to + 32767.
CLng	CLng (A) calculates the nearest long integer to the value A. Long integers are signed 32-bit values in the approximate range -21.5 M to + 21.5 M.
Cos	Cos (A) calculates the cosine of any integer or real number, giving an output that is never greater than plus one or less than minus one.
CSng	CSng (A) calculates a single precision real variable equal to A.
Exp	Exp (A) calculates the value of e^A .
Int	CInt (A) calculates the integer value next below A, which can be any acceptable VBS number. Int (-7.4) = -8.
Log	Log (A) calculates the natural logarithm (to base e), of any acceptable VBS number greater than zero. A negative number or zero will create an error. To calculate $\text{Log}_{10}(A)$, use $\text{Log}_{10}(A) = \text{Log}(A) / \text{Log}(10)$
Mod	A Mod (B) calculates the modulus of A, which is the remainder after A has been divided by B. 34 Mod 8 = 2. 34 Mod 55 = 0. -34 Mod 13 = -8. 21 Mod -8 = 5.

Randomize	Calculates a new seed for the pseudo-random number generator. Randomize Timer uses the real-time clock for this purpose.
Sin	Sin (A) calculates the sine of any integer or real number, giving an output that is never greater than +1 or less than -1.
Sqr	Sqr (A) calculates the square root of any integer or a real number that is not negative. If A is negative, an error will occur.
Timer	Time since the previous midnight in whole seconds.

Hints and Tips for VBScripting

Set the trigger to Single or Stopped if you need to do a lot of editing: it is faster.

Before starting a script, remove any existing scripts that you do not need. This is because errors in an existing script will give you error messages, even if your current script is perfect. And an existing good script may develop a fault if you change the setup. For example, you might change the vertical scale or the memory length and get an overflow if you did not guard against it in the script.

When starting a script, make sure that you have chosen the right kind: function or parameter. You can get some very frustrating problems if you are in the wrong mode. You can cut and paste the VBS statements if you discover this error.

If your calculation requires a long memory, development might be quicker if you test the principles on a shorter trace at first.

Note that the pseudo-random number generator is reset at the start of a script. If you want a different set of pseudo-randoms every time, put Randomize Timer in the program, to be run once, before any pseudo-randoms are generated. You can use this instruction to re-seed the generator at any time during execution.

Do not put the final statement in a loop, hoping that you can see a progressive result as some parameter changes. No output will be seen on the screen of the instrument until the script has been completely run and quitted, so only the final result will appear. If the loop runs many times, you will think that the scope has hung up.

If you want a For loop, end it with "Next" and not "Next X".

If you make a script that takes a long time to run, go back to the default setup before quitting or powering down, or you will have a long wait next time you power up.

Always use a recursive calculation when this will speed things up.

Keep everything outside a loop that does not have to be inside, to speed things up.

Make your scripts clear, not only by indenting and commenting, but by structuring neatly as well.

Sometimes it might be easier to develop your script in Excel VBA (remembering that VBA is not identical to VBS), so that you can display intermediate results. If you do this, note that you can read from a cell or write to it using statements like these:

```
A = Worksheets("Sheet1").Cells(Row, Column).Value
```

```
Worksheets("Sheet1").Cells(Row, Column).Value = B
```

Note that in VBS, after you have corrected an error and clicked on "Apply," the error message may go on flashing for a few seconds, or a few acquisitions, before being erased. Look for the "Script OK" message. Be patient before assuming that you still have a bug.

If your calculation requires data to be used at some other horizontal positions than their original ones, make sure that your algorithm does not try to send data to non-existent array positions, that is, beyond the edges of the screen. You may have to truncate your output trace, as happens with the instrument's Enhanced Resolution and Boxcar functions.

No output will emerge from a script until you press Apply.

No output will emerge from a script until it has received an input. This includes the case where the input data are not used in calculating the output data. So you must have had at least one acquisition before you see anything.

Because you can introduce undeclared variables at any point in a calculation, VBS does not check your spelling.

You can make a portion of a trace disappear if you set the values to 32767 or -32768.

You can highlight a section of a trace by making the points alternately too high and too low by a suitable amount. Providing the memory length is not too short, the compaction algorithm will give the effect of a thicker trace.

The lengths of the output trace and the input trace need not be the same. You can even make the output trace longer than the input trace, but you will need to unzoom it to see it all. This feature can be used to avoid compaction problems with non-linear horizontal scales. It can also be used to show several versions of a function at the same time, without having to set up a separate script for each one.

If your program structure is complicated, consider typing all the IFs, ELSEIFs, ENDIFs, FORs, NEXTs, etc and then clicking Apply. You won't get any output, but the system will tell you if the structure is acceptable. Then you can insert the actual program statements.

Always try to make the script as independent as possible of variables such as V/Div, T/Div, and memory length, unless that would make it harder to understand. If so, give some values as examples, and explain how the script would have to change if the variables changed.

Errors

The instrument VBS tries hard to help you when errors occur.

Errors may be of two main types:

- The script may not be usable because the interpreter cannot construct a logical structure from it.
- The script may be usable, but may fail while running because an incomputable function has been requested.

Sometimes the line number given for an error is wrong. This can happen when the error is of this general type:

Missing "Next" Missing "End If"

Extra "Next" Missing "Until" etc.

This happens because VBS cannot know where you should have put the statement.

If at some point during the calculation of an output array, a value goes outside the allowed range, the calculation will stop, and you will see the new values up to the point of the stoppage. To the right of that point, the trace will display the previous values. In fact, if you deliberately recalculate only a part of a trace, you can have a mixture of new and old values.

In the figure below is a type of error message that you may see if one of your calculations has tried to set a value outside the range -32768 to +32767. It takes extra time to guard against this, but unless you are sure that it will not happen, you need some kind of check. In the example on the next page, the red trace has gone outside the allowed range at the beginning, resulting in the message at the bottom of the instrument screen: This array is fixed or temporarily locked:

OutResult.DataArray.

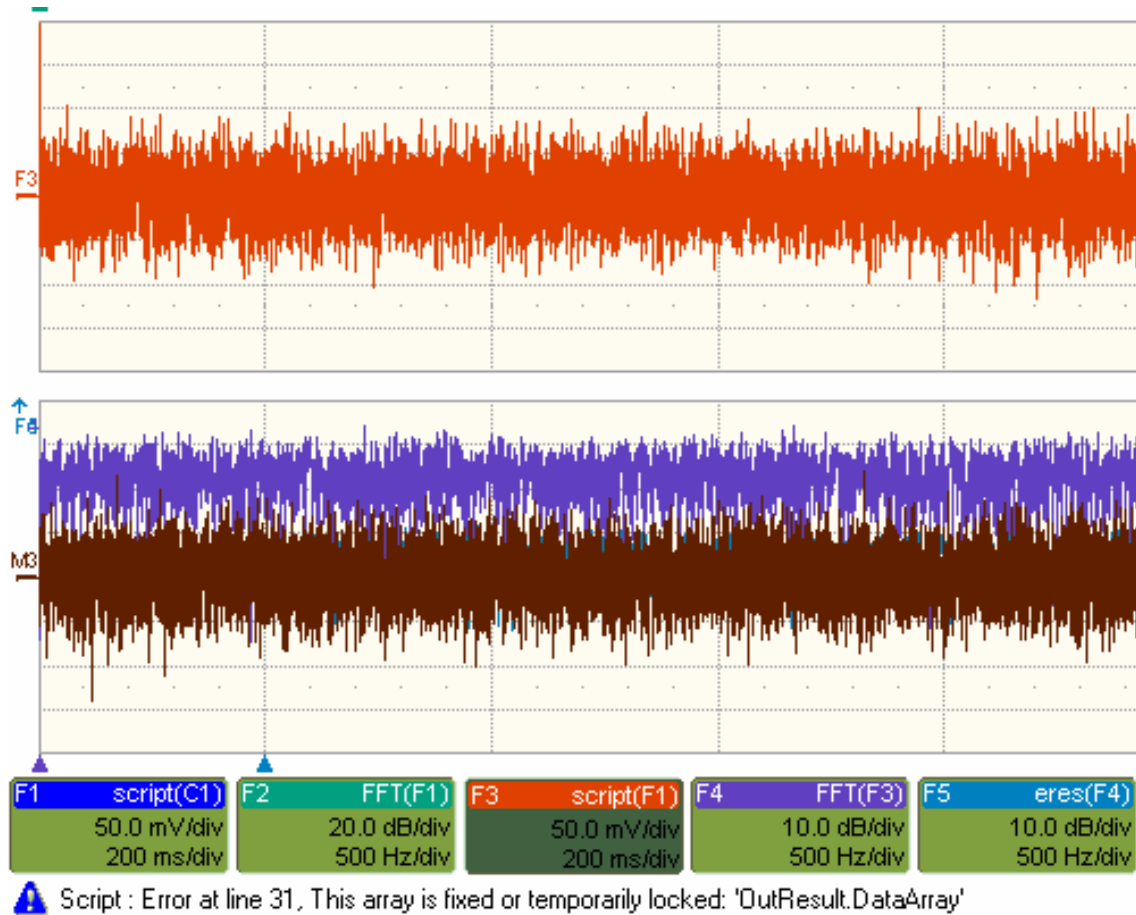

Error Handling

Note that the construction `OnError GoTo Label:` is not allowed in VBS. In fact no `GoTos` or labels are allowed. Therefore there is no way for you to provide handlers to deal with errors and exceptions. You must be aware of all possibilities at all points in your program, and you must either be certain that errors will not occur, or you must take action to ensure that they do not.

Examples:

Sqr	You cannot take the square root of a negative number.
Log	You cannot take the log of zero or of a negative number.
A / B	You cannot divide by zero.
Array	You cannot use an index outside the bounds of an array.
Size	Unscaled data cannot go outside the range -32768 to 32767.

If there is any possibility that any of these might occur, take steps to deal with this before it can happen.

For example, you may write some kind of generator of pseudo-random statistical values. If these belong to a distribution that in principle has an infinite range, or a finite range which is wider than the signed 16-bits allowed, check each value. If a value falls outside the range, you could set it to the maximum or generate another example.

You can, however, use one of the following:

```
On Error Resume Next
```

followed by some code that may make some attempt to deal with the problem, or at least to allow execution to continue.

```
On Error GoTo 0
```

This cancels `On Error Resume Next`

Speed of Execution

To maximize the speed of execution of a script, the most important thing you can do is to minimize the number of operations that are performed inside loops. Anything done once only is unlikely to be an important source of delay. Please note that VBS is much slower than the internal computations of the instrument, so do everything you can to save time, unless time is irrelevant to the application.

Using an array element takes longer than using a single variable. Here is an example:

```
For K = 1 to Total
  If X (K) > X (K - 1) Then
    Y = Cos (X (K) ) * Sin (X (K) ) * Sqr (X (K) )
```

```
End If
```

```
Next
```

To do the same thing we could also write this, using the index only once:

```
OldXK = X (0)
For K = 1 To Total
  XK = X (K)
  If XK > OldXK Then
    Y = Cos (XK) * Sin (XK) * Sqr (XK)
    OldXK = XK
  End If
Next
```

VBS runs slower than the "internal" calculations, because the scripts are interpreted. This could be serious for calculations where many operations are needed on each sample, such as convolution, correlation, and long digital filters.

Scripting Ideas

What can we do in a VBS script that we cannot do with the normal instrument functions? Here are some possibilities.

- Create a new function that acts on waveform values.
- Create a new parameter.
- Create a new form of non-linear vertical scale.
- Create a new form of non-linear horizontal scale.
- Move some or all data horizontally, including reflections.
- Combine data to form digital filters.
- Show several function results side by side.
- Show several function results interleaved.

You can even create output data that are not related to the input. The output data need not even be in the same domain as the input data, because the system treats them as pure numbers. So you can create your own transforms into the frequency domain, for example.

Debugging Scripts

Until we have integrated a more comprehensive debugger for VBScript there is a workaround.

1. Download the Windows Scripting Debugger for Windows 2000 from here:

<http://download.microsoft.com/download/winscript56/Install/1.0a/NT45XP/EN-US/scd10en.exe>

2. Enable JIT (Just In Time) debugging by setting the following registry key

HKCU\Software\Microsoft\Windows Script\Settings\JITDebug = to 1 (DWORD value)

3. Place a **Stop** statement in your script.

Now, when the Stop statement is executed the debugger will open and allow single-stepping, variable examination, etc.

Using VBA or Visual Basic to debug VBScripts is not recommended since the language syntax for these three variants of basic is slightly different.

Horizontal Control Variables

InResult.HorizontalOffset	Double precision	Time shift of input waveform on grid in units of horizontal scale
OutResult.HorizontalOffset	Double precision	Time shift of output waveform on grid in units of horizontal scale
InResult.HorizontalPerStep	Double precision	Time between successive samples in the input waveform
OutResult.HorizontalPerStep	Double precision	Time between successive samples in the output waveform
InResult.HorizontalUnits	String	Horizontal units of input waveform
OutResult.HorizontalUnits	String	Horizontal units of output waveform
InResult.Samples	Integer	Number of samples in input waveform

Vertical Control Variables

InResult.VerticalOffset	Double precision	Vertical shift of input waveform on grid
OutResult.VerticalOffset	Double precision	Vertical shift of output waveform on grid
InResult.VerticalPerStep	Double precision	Difference between successive possible levels in the input waveform memory
OutResultVerticalPerStep	Double precision	Difference between successive possible levels in the output waveform memory 1 / 65536 of vertical full scale

InResult.VerticalResolution	Double precision	Difference between successive possible physical levels in the input waveform
OutResultVerticalResolution	Double precision	Difference between successive possible physical levels in the output waveform 1 / 256 of vertical full scale for channel waveforms 1 / 65536 of vertical full scale for math waveforms
InResult.VerticalUnits	String	Vertical units of input waveform
OutResult.VerticalUnits	String	Vertical units of output waveform

List of Variables Available to Scripts

FirstEventTime([out, retval] VARIANT * pVal); FirstEventTime([in] VARIANT newVal);
 LastEventTime([out, retval] VARIANT * pVal); LastEventTime([in] VARIANT newVal);
 UpdateTime([out, retval] VARIANT * pVal); UpdateTime([in] VARIANT newVal);
 Details([in] BSTR strDetailsIID, [out, retval] VARIANT * pVal);
 Status([out, retval] VARIANT * pVal); Status([in] VARIANT newVal);
 ExtendedStatus([out, retval] VARIANT * pVal); ExtendedStatus([in] VARIANT newVal);
 StatusDescription([out, retval] BSTR * pVal); StatusDescription([in] BSTR newVal);
 DataArray([in, defaultvalue(TRUE)] BOOL arrayValuesScaled,
 [in, defaultvalue(LEC_ALL_DATA)] int numSamples,
 [in, defaultvalue(0)] int startIndex,
 [in, defaultvalue(1)] int sparsingFactor,
 [out, retval] VARIANT *pArray);
 DataArray([in, defaultvalue(TRUE)] BOOL arrayValuesScaled,
 [in, defaultvalue(LEC_ALL_DATA)] int numSamples,
 [in, defaultvalue(0)] int startIndex,
 [in, defaultvalue(1)] int sparsingFactor,
 [in] VARIANT array);
 HorizontalUnits([out, retval] BSTR *pVal); HorizontalUnits([in] BSTR newVal);
 Samples([out, retval] int *pVal); Samples([in] int newVal);
 HorizontalResolution([out, retval] double *pVal); HorizontalResolution([in] double newVal);
 HorizontalPerStep([out, retval] double *pVal); HorizontalPerStep([in] double newVal);

HorizontalOffset([out, retval] double *pVal); HorizontalOffset([in] double newVal);
Sweeps([out, retval] int *pVal); Sweeps([in] int newVal);
HorizontalVariances([out, retval] int *pVal); HorizontalVariances([in] int newVal);
HorizontalVarianceArray([out, retval] VARIANT * pArray);
HorizontalVarianceArray([in] VARIANT array);
HorizontalFrameStart([out, retval] double *pVal); HorizontalFrameStart([in] double newVal);
HorizontalFrameStop([out, retval] double *pVal); HorizontalFrameStop([in] double newVal);
VerticalFrameStart([out, retval] double *pVal); VerticalFrameStart([in] double newVal);
VerticalFrameStop([out, retval] double *pVal); VerticalFrameStop([in] double newVal);
VerticalResolution([out, retval] double *pVal); VerticalResolution([in] double newVal);
VerticalPerStep([out, retval] double *pVal); VerticalPerStep([in] double newVal);
VerticalOffset([out, retval] double *pVal); VerticalOffset([in] double newVal);
VerticalMinPossible([out, retval] double *pVal); VerticalMinPossible([in] double newVal);
VerticalMaxPossible([out, retval] double *pVal); VerticalMaxPossible([in] double newVal);
VerticalUnits([out, retval] BSTR *pVal); VerticalUnits([in] BSTR newVal);

Communicating with Other Programs from a VBScript

The ability of The instrument to communicate with other programs opens up immense possibilities, both for calculation and for graphics, making the assembly of reports relatively simple.

Communicating with Excel from a VBScript

Although there are direct instrument calls to Excel and other programs, you may wish to do this from a VBScript. Here is an example:

```
OutResult.Samples = InResult.Samples
startData = 0
endData = OutResult.Samples
ReDim newData(OutResult.Samples)
USD = InResult.DataArray(False)
LastPoint = endData - 1
Set ExcelApp = GetObject(,"Excel.Application")
ExcelApp.Visible = True
ExcelColumnA = 2      'Column where the data will appear in Excel
ExcelRow = 10         'Row where the data will start
ExcelColumnB = 3     ' Column where the output data will appear in Excel
```

```
For K = 0 To LastPoint
ExcelApp.ActiveSheet.Cells("ExcelRow + K, ExcelColumnA ") = -USD(K)
Next
```

Once the data are in Excel, any Excel functions can be applied to the data. The results can be returned to the VB script.

```
For K = 0 To LastPoint
NDA(K) = ExcelApp.ActiveSheet.Cells("ExcelRow + K, ExcelColumnB")
Next
```

Transferring data cell by cell is very slow, so it is better to do a block transfer.

Calling MATLAB from the Instrument

Calling MATLAB

Note: Load MATLAB version 6.5 just as you would on any PC. Once it is loaded, open MATLAB from the desktop, then close it again, before you attempt to open it from the instrument application. This is to update the registry.

MATLAB can be directly called from the instrument in two ways:

Using a function	F1 through Fx The number of math traces available depends on the software options loaded on your scope. See Specifications.	MATLAB returns a waveform
Using a parameter	P1 through Px	MATLAB returns a parameter

In both cases, one call to MATLAB can use two separate waveforms as input, providing much greater computing power than is available by calling MATLAB from a VBScript.

Note: If you do not place a semicolon ";" at the end of a line, MATLAB will show the calculated value in the result window, significantly slowing down the processing rate. This feature is best kept for diagnostics.

How to Select a Waveform Function Call

The MATLAB Waveform functions are selected from the **Select Math Operator** menu. Please note that once you have clicked on "MATLAB Wave" there will be a slight pause before MATLAB starts.

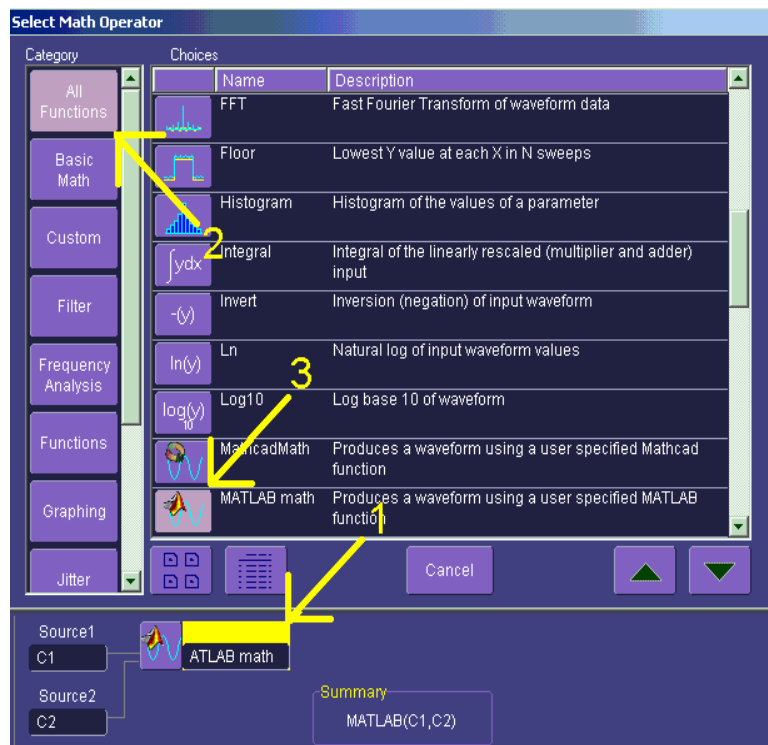

Source 1 and Source 2 are the waveforms that MATLAB will use.

The MATLAB Waveform Control Panel

Once you have invoked a MATLAB waveform call, you will see the zoom dialog at the right of the screen. Touch the MATLAB tab to see a panel like this:



Touch **Find Scale** to make your output fit the grid, or use the text boxes to choose a scale.

MATLAB Waveform Function Editor -- Example

By touching **Edit Code**, you can reach the MATLAB Editor where you will see the default waveform function. If you are familiar with MATLAB, you might prefer to launch MATLAB and create a MATLAB function that performs your task. Your program in the instrument could then be a one-line call of your MATLAB function.

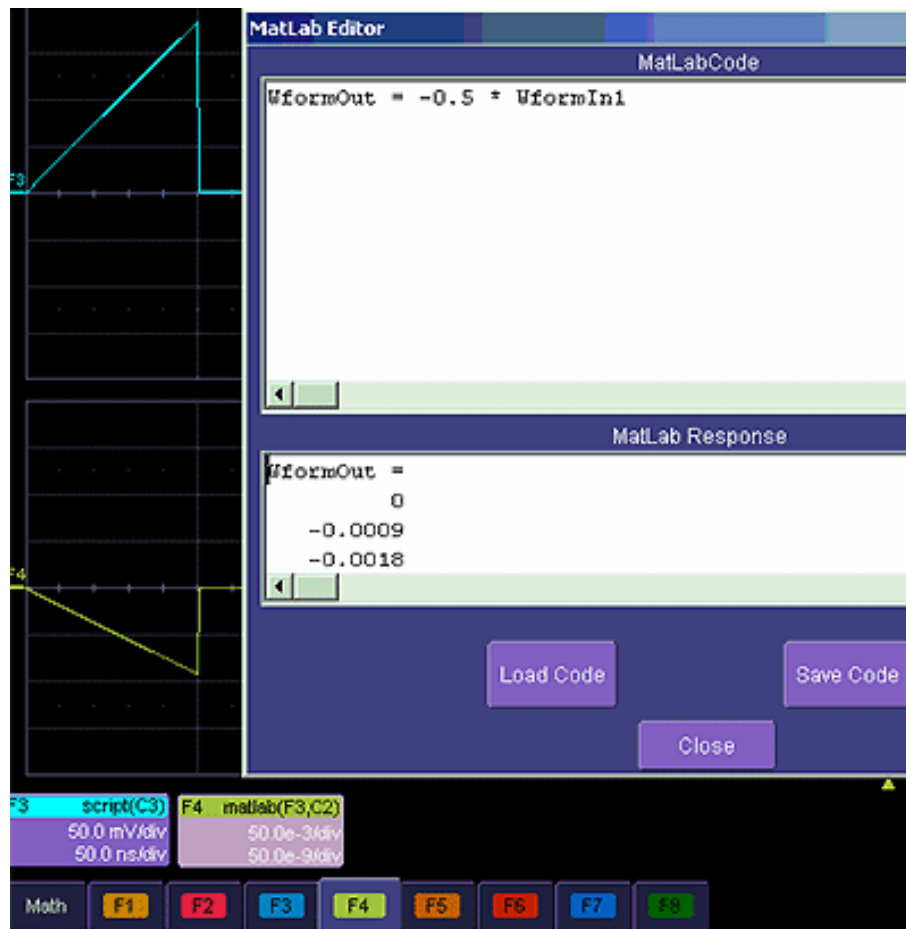

This is the default waveform function, with one important change: the semi-colon (;) has been removed from the end of the line. If the semicolon is present, your function will run much faster, because the output values will not be shown in MATLAB Response. With a long waveform, the time needed to display it could be quite long. The response values can be useful during development and debugging. Any line without a semicolon will produce a visible MATLAB Response.

From this panel you can save your code, load a previous code, and edit your function. A powerful feature of MATLAB is that you can refer to an entire waveform as a vector. The two input waveforms are WformIn1 and WformIn2, while the output is WformOut. You can also refer to individual samples, such as WformIn1(34), and sequences of samples, such as WformIn(55:89)

You can write statements such as these:

```
WformOut(5) = WformIn(5)
WformOut(89) = WformIn(144)
WformOut(34:55) = WformIn(34:55)
```

```
WformOut(233:377) = WformIn(100:244)
```

This very simple example adds a rescaled copy of Channel 2 to a copy of Channel 1, and then rescales the result.

The screenshot displays the X-STREAM software interface. On the left, three waveform displays are visible: Channel 1 (C1) showing a sine wave, Channel 2 (C2) showing a square wave, and Function 1 (F1) showing a sine wave. The MatLab Editor window on the right contains the following code:

```
WformOut = 1.9 * (WformIn1 + 0.5 * WformIn2);
```

Below the code editor are three buttons: "Load Code", "Save Code", and "Close". At the bottom of the interface, there are control panels for each channel and function, including a "Math" button and function keys F1 through F8.

Channel	Scale	Offset
C1	40.0 mV/div	0 V offset
C2	40.0 mV/div	0 V offset
F1	40.0e-3/div	500e-9/div

MATLAB Example Waveform Plot

If you touch the **MATLAB Plot** checkbox you will see a MATLAB plot like this one:

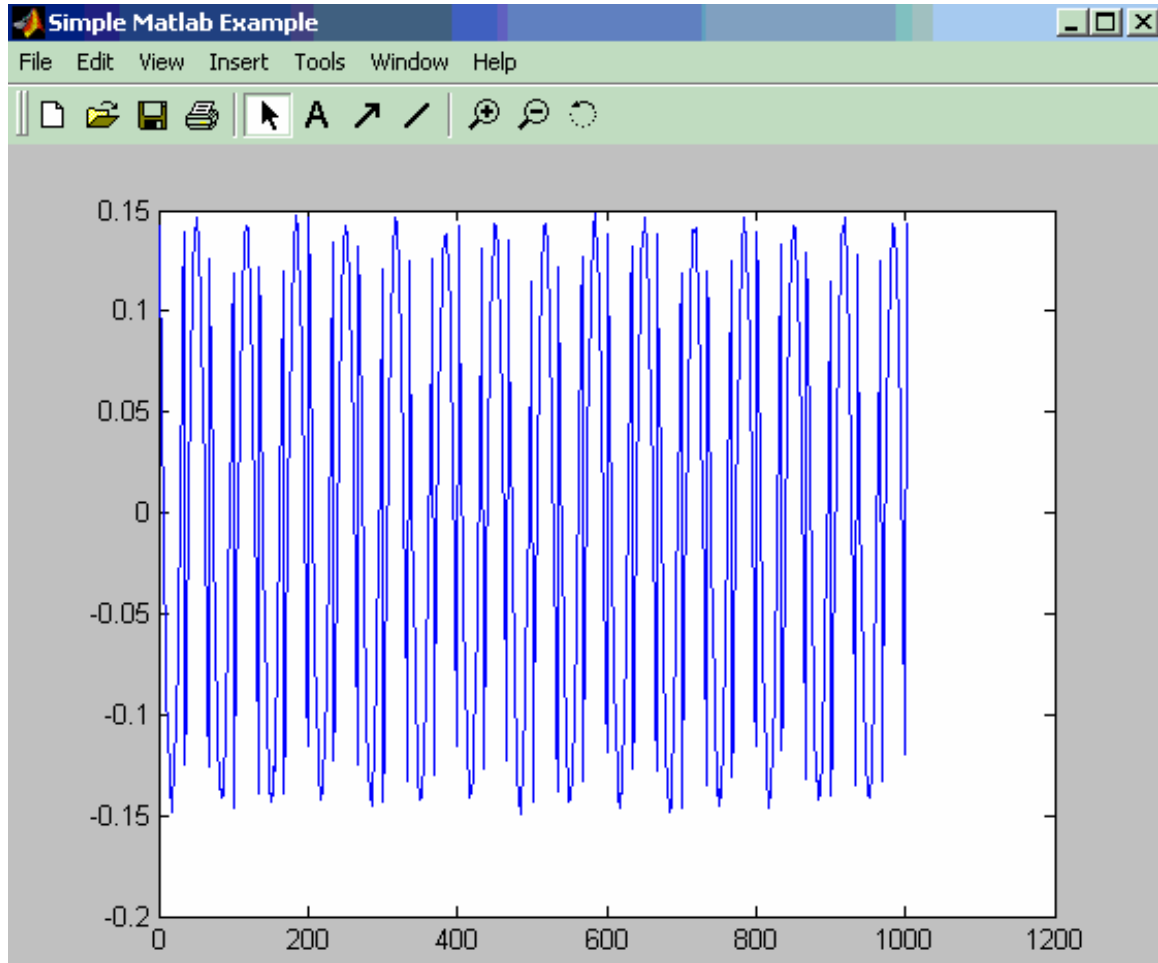

How to Select a MATLAB Parameter Call

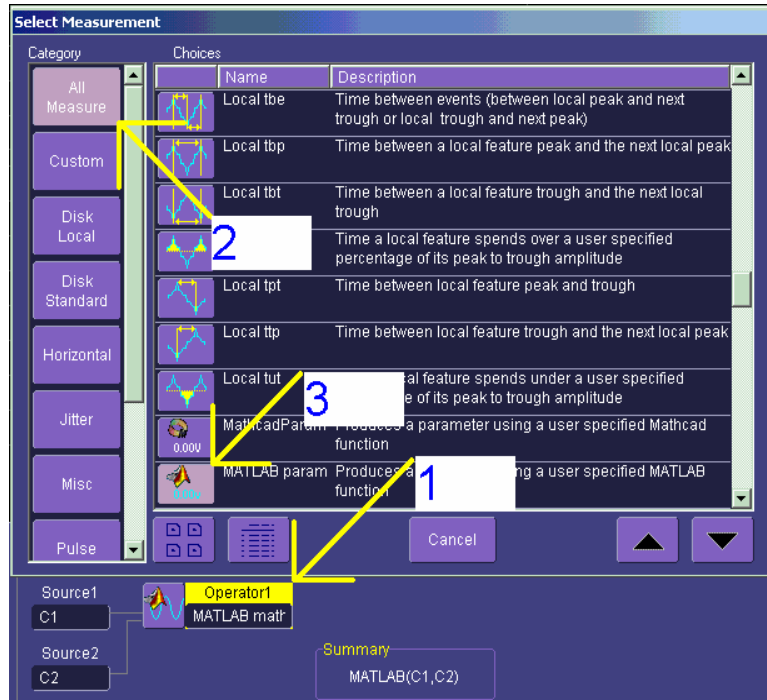

Menu position for MATLAB parameter call in **Select Measurement** menu.

The MATLAB Parameter Control Panel

Once you have invoked a MATLAB parameter call, a mini-dialog to the right of the main dialog will appear:

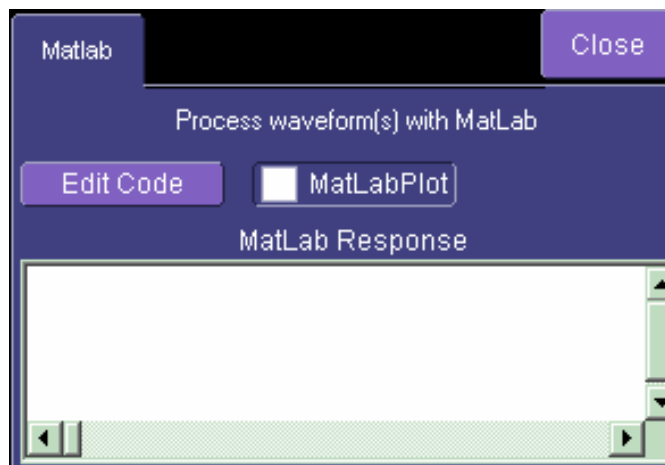

You can touch the **MATLAB Plot** checkbox if you want to see a plot in MATLAB as well as getting

a result in the instrument.

The MATLAB Parameter Editor

By touching **Edit Code**, you can reach the MATLAB Editor:

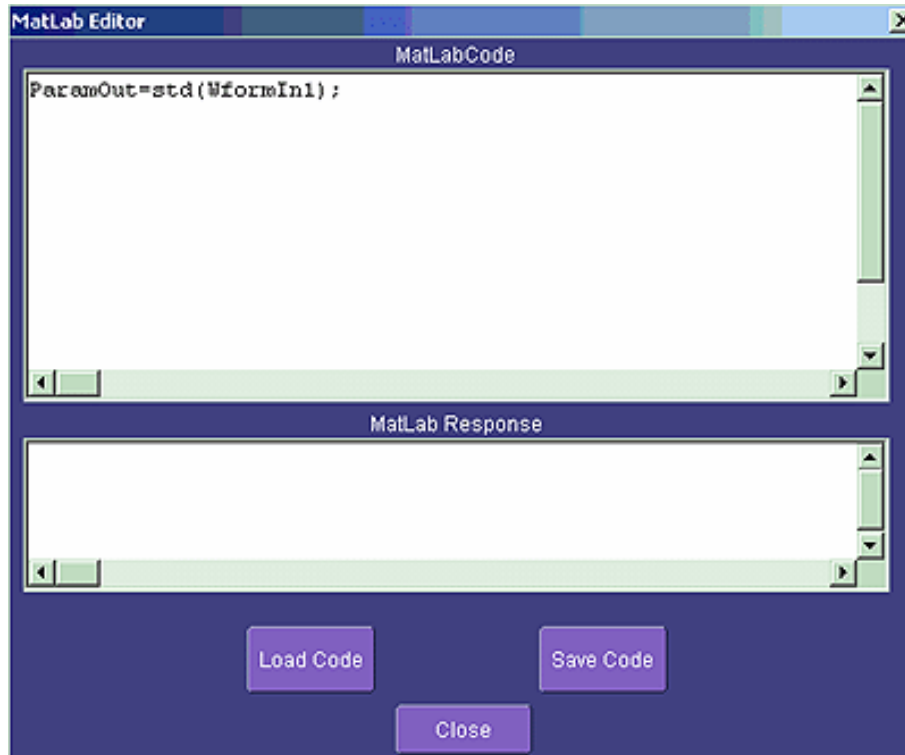

This simple example shows the MATLAB function Standard Deviation acting on input channel 1, and the result would be shown in the **MATLAB Response** pane for an amplitude of 0.15 volt.

You can load an existing MATLAB program, using the **Load Code** button, and you can save the current program, using the **Save Code** button.

If you are familiar with MATLAB you might prefer to launch MATLAB and create a MATLAB function that performs your task. Your program in the instrument could then be a one-line call of your MATLAB function.

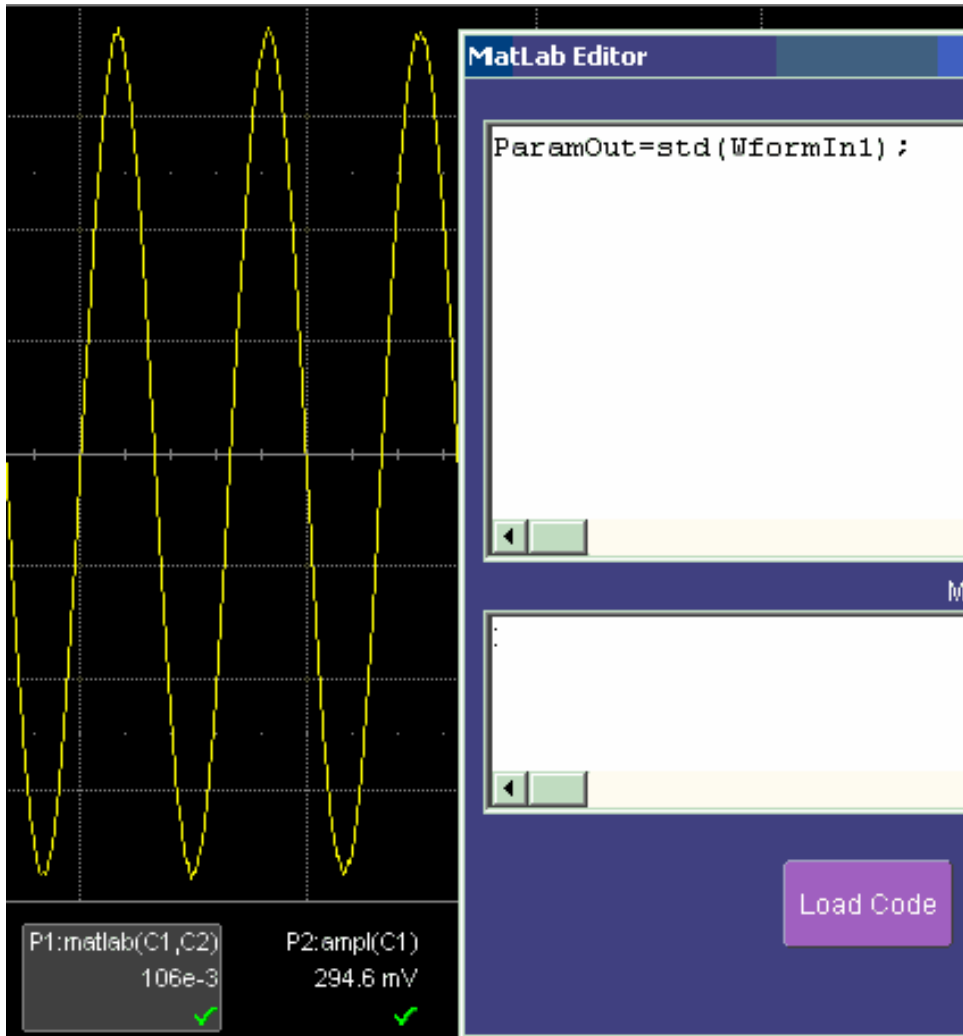

The next example calculates the ratio of the number of data points that are above a given level to the number of points below the level, in this case one half of the amplitude.

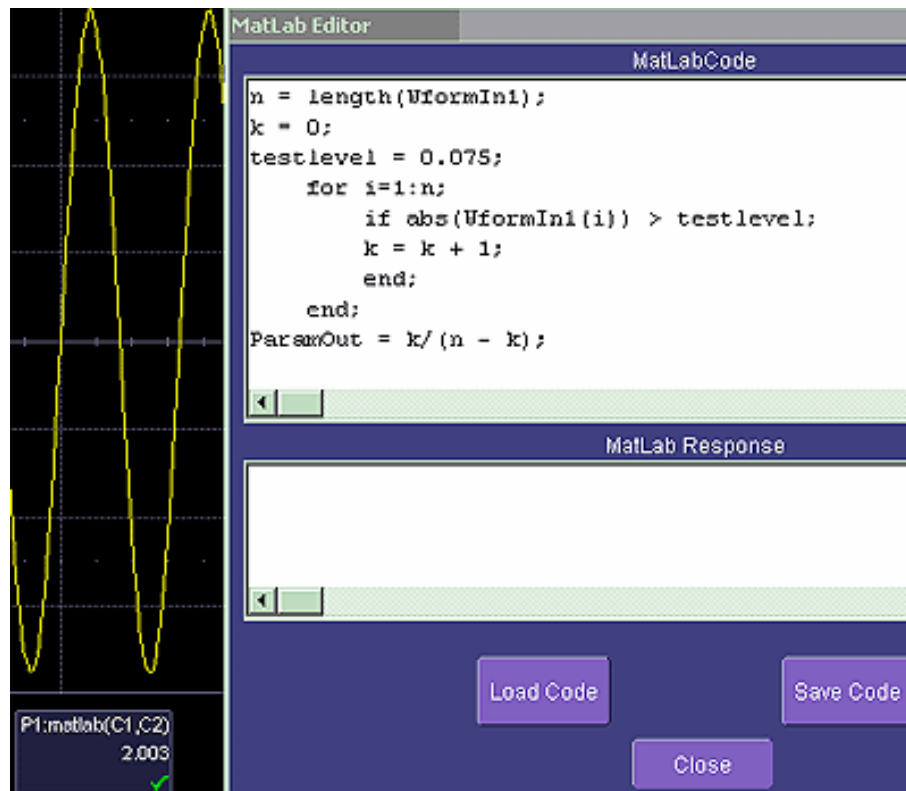

Further Examples of MATLAB Waveform Functions

Negate the input signal.

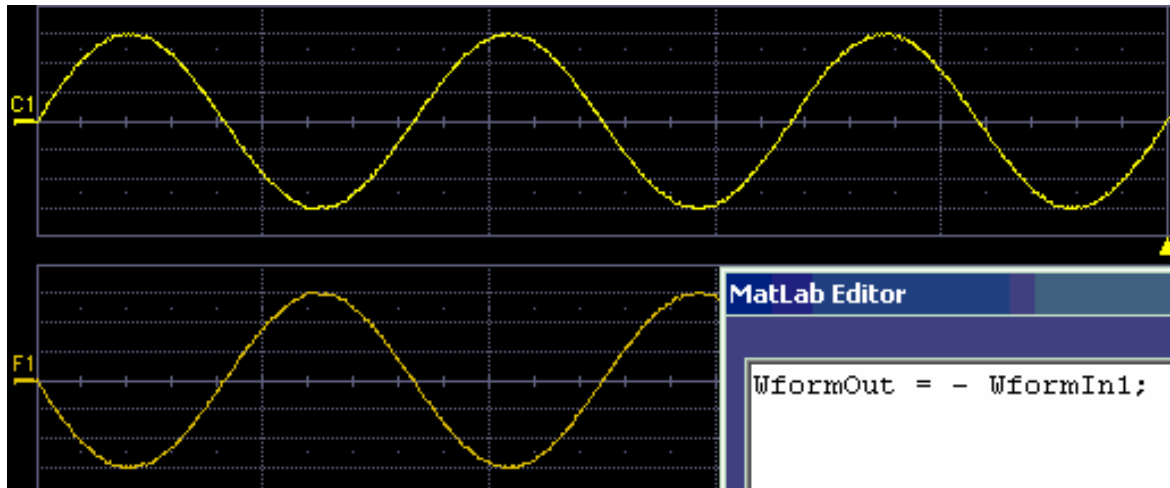

Square the input signal.

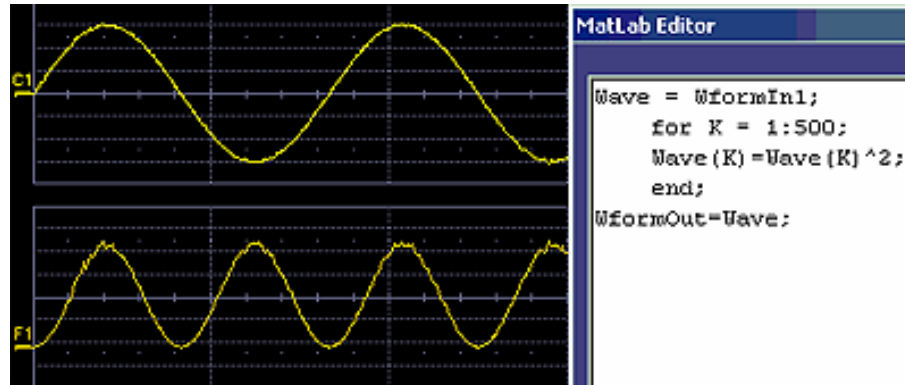

Create pulses from a sinusoid.

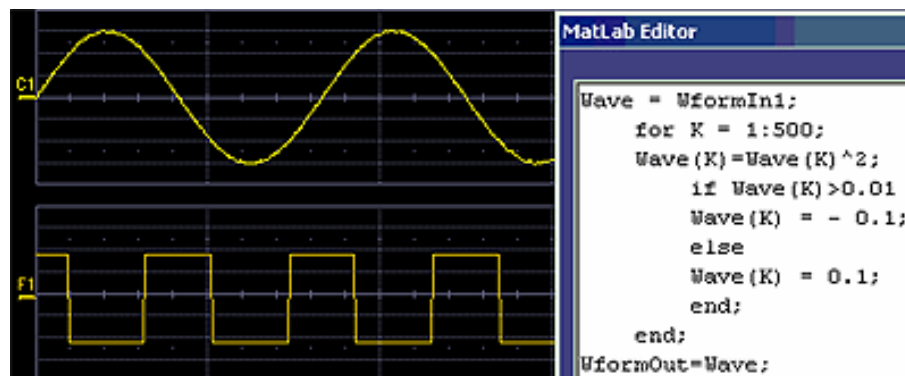

Create pulses at the zero crossings of the signal.

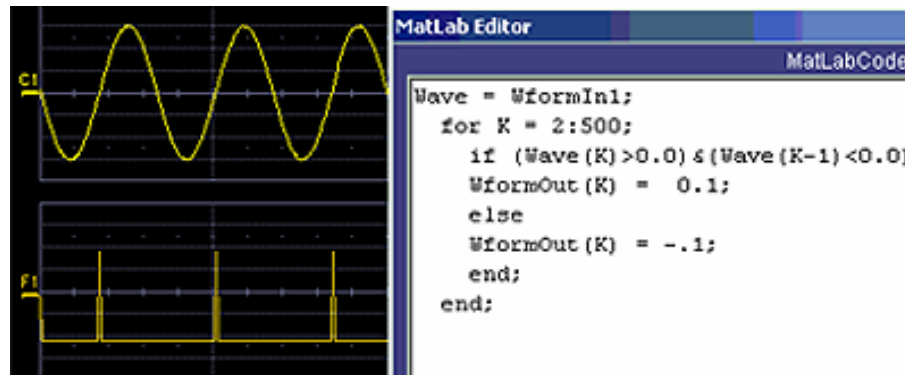

Convolve two signals.

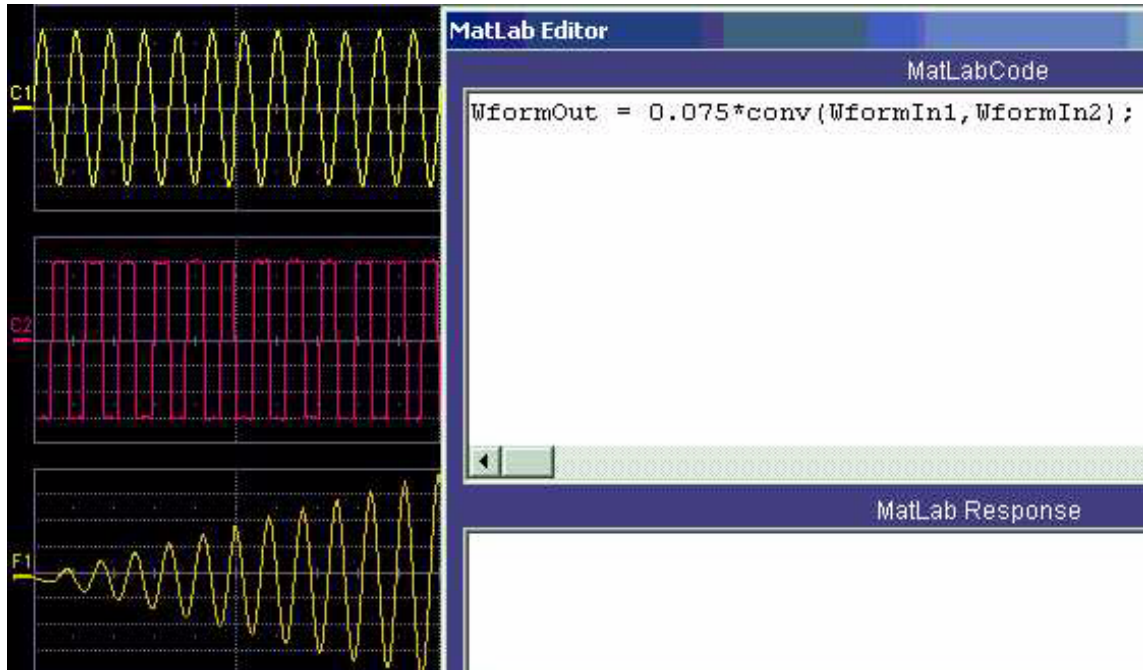

Creating your own MATLAB function

The procedure is simple. Create a MATLAB function using any text editor, and save it as a MATLAB m-file by giving it a name of the form Filename.m. Call the function using the MATLAB math editor or the MATLAB parameter editor as appropriate. A simple example is shown below.

```
function out = negatewf(wf1)
    % NEGATEWF changes the sign of all the data.
    out = -wf1;
```

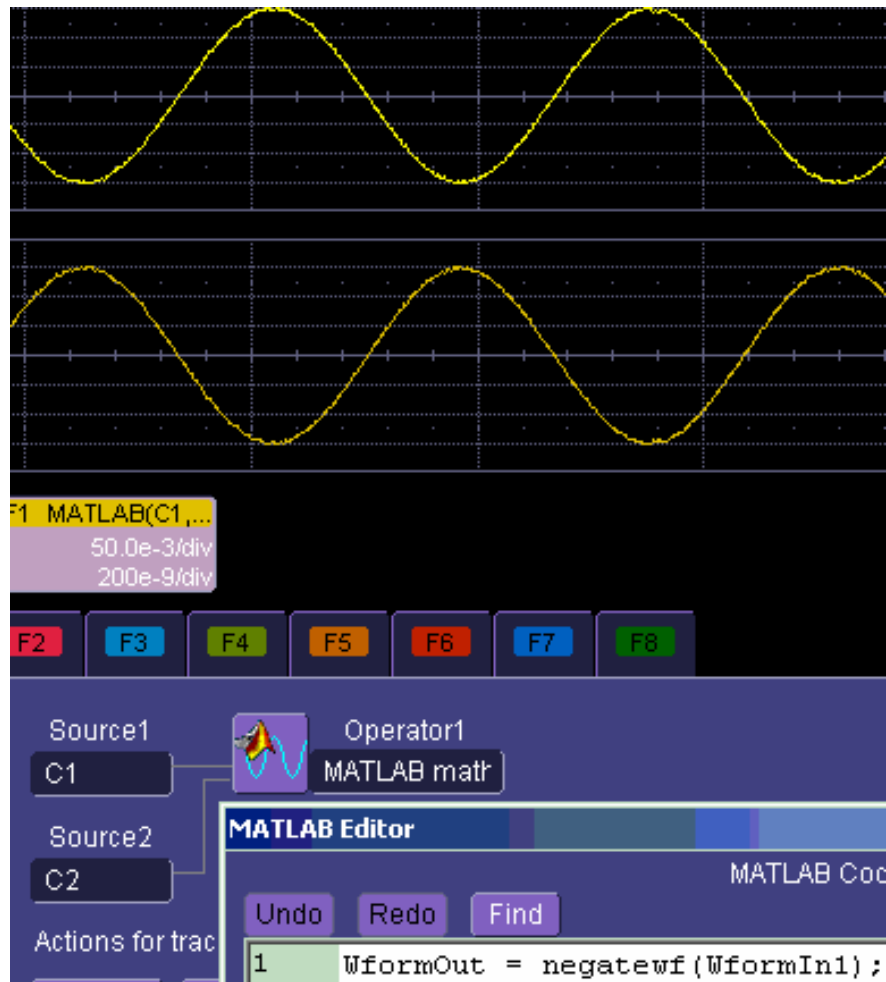

CUSTOMDSO

Custom DSO

Introduction - What is CustomDSO?

CustomDSO, in its Basic mode, allows you to create DSO setups that can be called by the touch of a single button. The recalled setups can themselves include calls to other setups. A very simple example would be a toggle between two setups. Rings of three or more setups are possible, as are trees, or any other topology that you need. Basic mode also allows you to recall VBScripts that can set up all or part of the scope and do many other things.

Another more powerful feature is the PlugIn, which allows you to add your own ActiveX controls to a setup. These controls are powered by routines written in Visual Basic. With ActiveX controls you can create your own user interfaces to suit your own preferences. A large number of interactive devices are available: button, checkbox, radio button, list box, picture box, and common dialogue box.

Invoking CustomDSO

CustomDSO can be invoked from the **Analysis** drop-down menu:



If CustomDSO is already in Basic mode, the following dialog will be displayed:

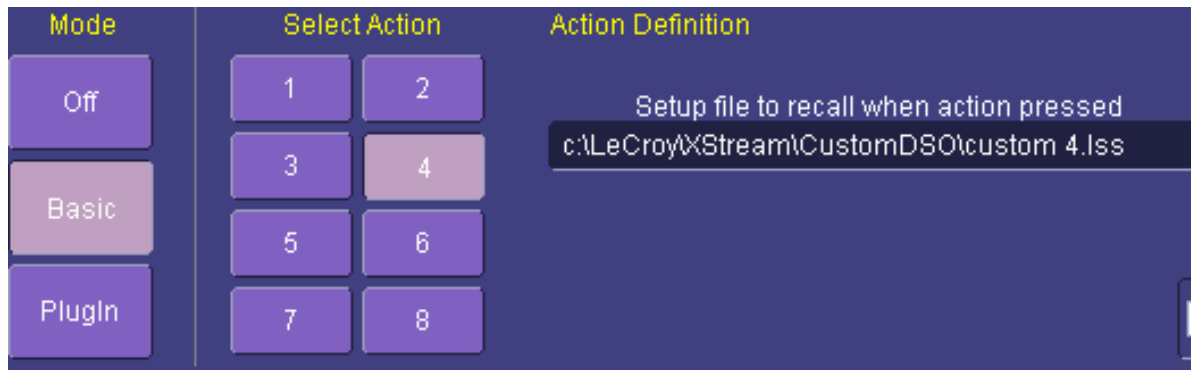

CustomDSO Basic Mode

The **Basic** CustomDSO mode offers eight Action buttons, each of which can call a different setup when touched. The "Action Definition" dialog is used to enter a CustomDSO setup file name by means of the pop-up keyboard.

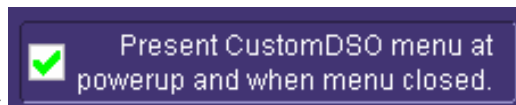

By clicking the checkbox, the eight CustomDSO buttons will continue to be available at the bottom of the screen after you close the CustomDSO dialog. Furthermore, they will appear automatically each time the scope is powered up.

Editing a CustomDSO Setup File



If the file does not exist, touch the **Edit** button; a dialog will appear for you to create the file. If the file does already exist, the **Edit** button enables you to modify it. The **Edit** button allows you to edit the file that is named in the **Setup file to recall** field, and not the file of the setup that the instrument is currently in, unless these happen to be the same.

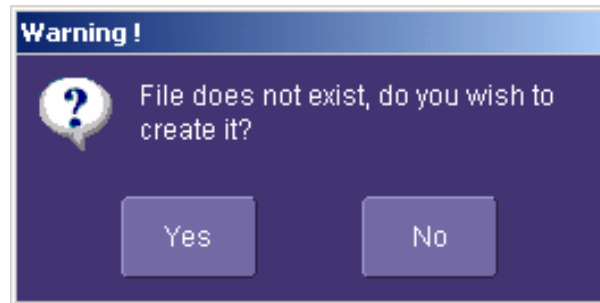

In the example used here, three setup files were made, called CustomA.Iss, CustomB.Iss and CustomC.Iss. Fragments from all three are shown below.

```
1160 set CustomDSO = XStreamDSO.CustomDSO
1161 ' CustomDSO Setup A.Iss
```

```
1162 CustomDSO.ActionScript1 = "c:\LeCroy\XStream\CustomDSO\A.iss"
1163 CustomDSO.ActionEnable1 = False
1164 CustomDSO.ActionScript1 = "c:\LeCroy\XStream\CustomDSO\B.iss"
1165 CustomDSO.ActionEnable1 = True
1166 CustomDSO.ActionScript1 = "c:\LeCroy\XStream\CustomDSO\C.iss"
1167 CustomDSO.ActionEnable1 = True
1168 CustomDSO.ActionScript1 = "c:\LeCroy\XStream\CustomDSO\A.iss"
1169 CustomDSO.ActionEnable1 = False

1160 Set CustomDSO = XStreamDSO.CustomDSO
1161 ' CustomDSO Setup B.iss
1162 CustomDSO.ActionScript1 = "c:\LeCroy\XStream\CustomDSO\A.iss"
1163 CustomDSO.ActionEnable1 = True
1164 CustomDSO.ActionScript1 = "c:\LeCroy\XStream\CustomDSO\B.iss"
1165 CustomDSO.ActionEnable1 = False
1166 CustomDSO.ActionScript1 = "c:\LeCroy\XStream\CustomDSO\C.iss"
1167 CustomDSO.ActionEnable1 = True
1168 CustomDSO.ActionScript1 = "c:\LeCroy\XStream\CustomDSO\A.iss"
1169 CustomDSO.ActionEnable1 = False

1160 Set CustomDSO = XStreamDSO.CustomDSO
1161 ' CustomDSO Setup C.iss
1162 CustomDSO.ActionScript1 = "c:\LeCroy\XStream\CustomDSO\A.iss"
1163 CustomDSO.ActionEnable1 = True
1164 CustomDSO.ActionScript1 = "c:\LeCroy\XStream\CustomDSO\B.iss"
1165 CustomDSO.ActionEnable1 = True
1166 CustomDSO.ActionScript1 = "c:\LeCroy\XStream\CustomDSO\C.iss"
1167 CustomDSO.ActionEnable1 = False
1168 CustomDSO.ActionScript1 = "c:\LeCroy\XStream\CustomDSO\A.iss"
1169 CustomDSO.ActionEnable1 = False
```

The text in green following a single quotation mark is a VBS comment and causes no action.

The text in red contains the path and name of the setup file associated with the numbered button. This setup will be called when the button is pressed.

The Boolean (in blue) decides whether the action button will invoke the setup or remain inactive.

For example, in setup B, **A.Iss** and **C.Iss** can be invoked, but not B, which is already in place.

As you see from the line numbers in the program fragments, the setup files are rather long because they include all the information needed to set the scope to the required state. But if you want to make a very short file that changes only a few variables (for example, the action button settings) you can make a file that includes only the relevant instructions. This usage assumes that the remainder of the scope is already in the required state. This is an example of the complete compatibility of the instrument's software. The same commands can be used in setups, in scripts, or in remote control commands in external programs, whether resident in the instrument or in an external computer.

Creating a CustomDSO Setup File



If you touch the **Edit** button when the **Setup file to recall** field contains the name of a non-existent file, you will see a message like this:

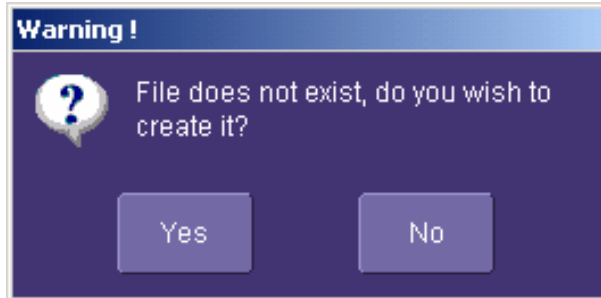

If you then touch **Yes**, the scope will display a file like this:

```
' XStreamDSO ConfigurationVBScript ...  
' Created by CustomDSO ...  
On Error Resume Next  
set dso = CreateObject("LeCroy.XStreamDSO.1")  
' dso.Display.GridMode = "Dual"  
' dso.Acquisition.C1.VerScale = 0.1  
' dso.Acquisition.Horizontal.HorScale = 1e-6  
' dso.Acquisition.TriggerMode = "Auto"
```

You can add to this fragment any commands you need.

CustomDSO PlugIn Mode

This is the mode in which CustomDSO really shows its power. You can insert any ActiveX control or graph.

Creating a CustomDSO PlugIn

Follow these steps to create an example Visual Basic PlugIn:

1. Start a new VB project. Select **ActiveX Control** from the **New** tab.
2. Resize the control. A. In the Properties window set Width 11940. B. In the Properties window set Height 2475.
3. Place two buttons on the control.
 - A. Double click on the command button at left of screen (left arrow below).
 - B. Move and resize the resulting button as required, using the handles (right arrow below).

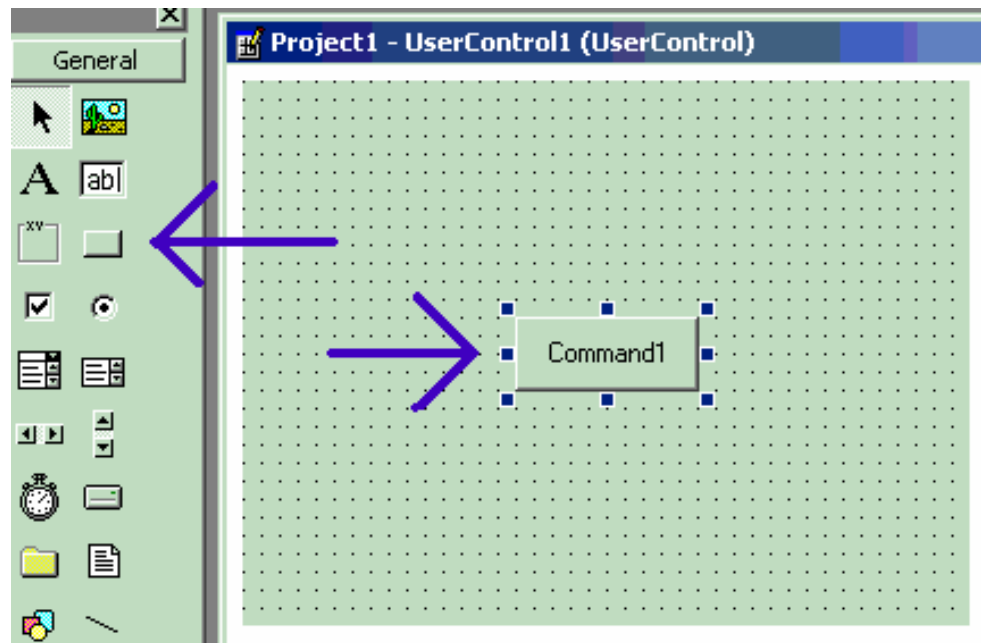

- C. Repeat for the second button. D. In the Properties window set the Name properties to **SingleButton** and **AutoButton**, respectively. E. Set the button Caption properties to **Single** and **Auto**, respectively
4. Create code for the buttons. A. Double click on the **Single** button. B. In the resulting code window, insert code to make the following subroutine:

```
Private Sub SingleButton_Click()
    Dim app as Object
    Set app = CreateObject("LeCroy.XStreamApplication")
    app.Acquisition.TriggerMode = "Stopped"
End Sub
```

 Double click on the **Auto** button.

In the resulting code window, insert code to make the following subroutine:

```
Private Sub AutoButton_Click()
    Dim app as Object
    Set app = CreateObject("LeCroy.XStreamApplication")
    app.Acquisition.TriggerMode = "Auto"
End Sub
```
 5. Test the Component in Internet Explorer. (This is an optional, but very useful step, because you can test your work without installing anything in the instrument.) A. Start the instrument. B. Click the **Run** button In Visual Basic. C. Click the **Stop** button in Visual Basic when you have finished.
 6. Make the Project in Visual Basic. A. Click the **Stop** button in Visual Basic. B. Select Make

Project1.ocx from the File menu.

7. Install the PlugIn in the instrument. A. Start the instrument. B. Select **ActiveDSO** in the Analysis Menu. C. Select **Plugins** mode. D. Type "Project1.UserControl1" in the "COM ProgID of Plug-In" text box. E. Click the Install button under the text box.
8. Now Click the new **Auto** and **Single** buttons to see their effects.

Properties of the Control and its Objects

Using the **View Properties** button in Visual Basic, you can customize your PlugIn to your exact requirements. Among the most useful properties are the following: Height, Width, BackColor, Name, Caption.

You can gain access to the properties of your objects by Clicking View - Properties. Positions and sizes of objects can be changed from View - Object, by dragging the object or one of its handles.

You can insert any available control into your plug-in. The basic control set is shown in a toolbar at the left of the screen in the picture below. Double click on any control to insert it into the plug-in. In the following example, a command button has just been inserted.

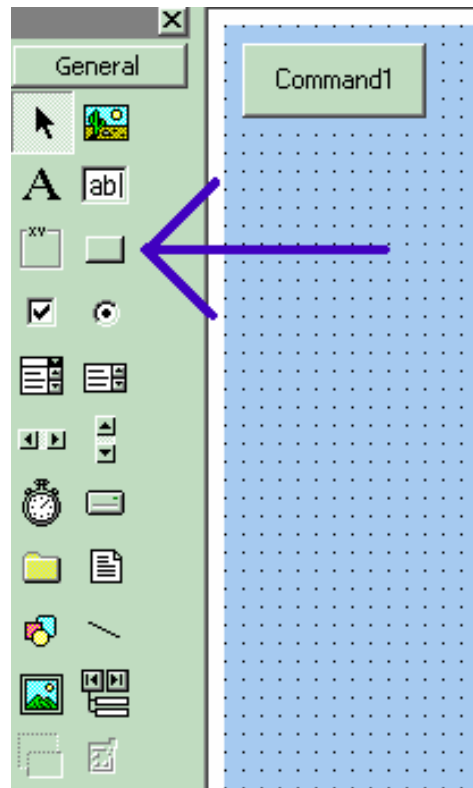

In the next example you can see a command button, a picture box, a list box and a Tabbed Dialog Control.

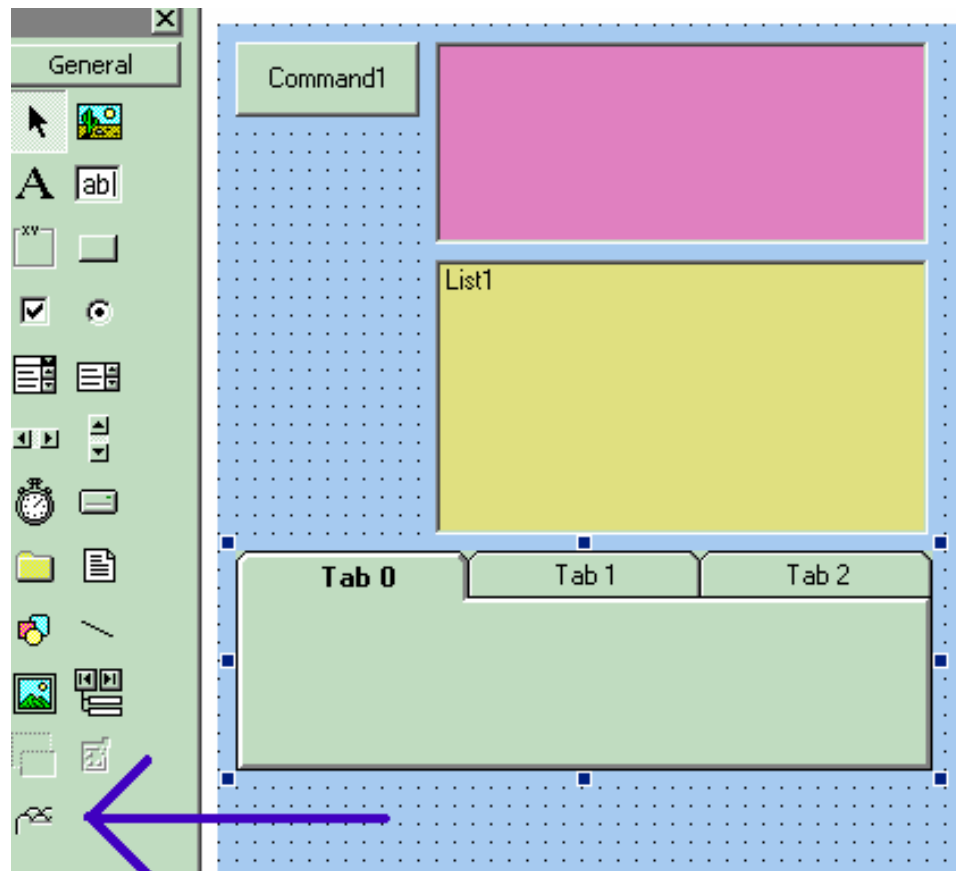

The Tabbed Control (arrow) is not in the basic tool box. To gain access to it, right click in the tool box at left (but not on an icon.) You will see this menu:

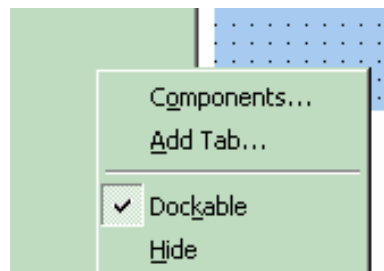

Now select the Microsoft Tabbed Control as shown below, and click on Apply. The control will be added into the toolbox at the left of the screen, where you can double click on it as usual.

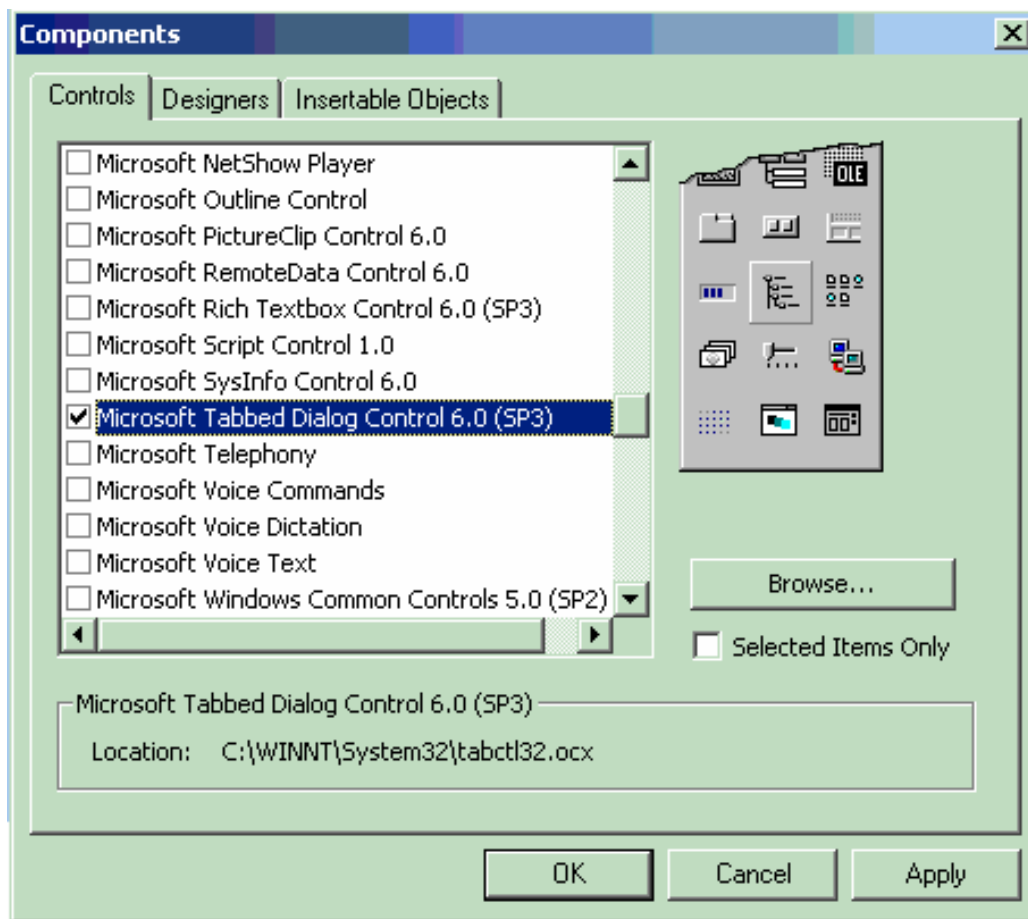

The new control is shown below (arrow).

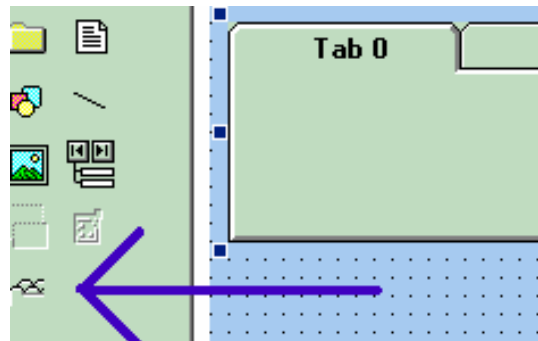

The system is very versatile, and you can place controls on the tabs of the Tabbed Control. Look in the properties window to see how you can customize your tabs, as illustrated below.

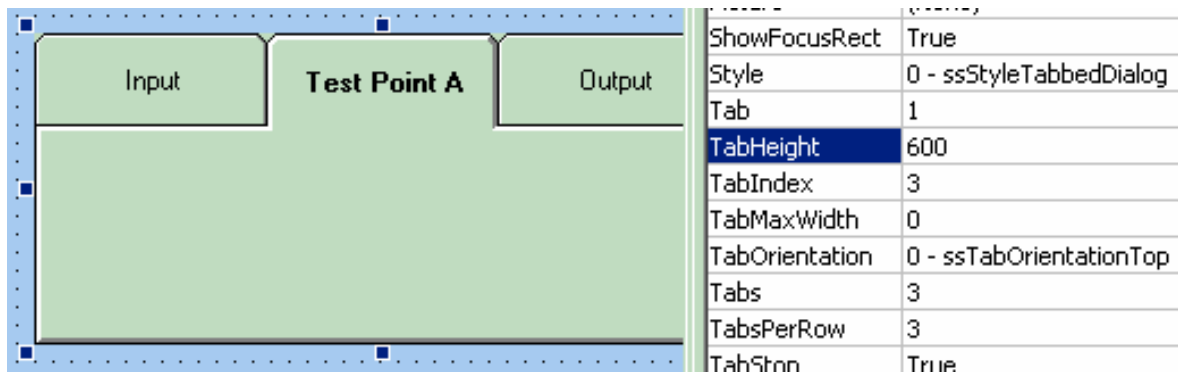

Removing a PlugIn

To remove a plug-in, click on Remove in the PlugIn dialog, as shown below:

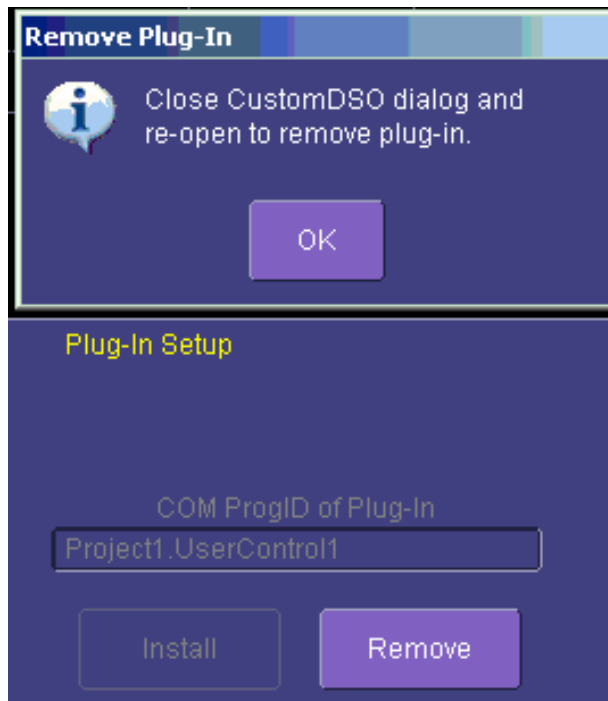

Close the CustomDSO dialog and reopen; the plug-in will vanish.

First Example PlugIn - Exchanging Two Traces on the Grids

The example assumes that the instrument is in dual-grid mode, and that there are at least two visible traces. The routine looks for the visible traces, in the order C1 . . . C4, F1 . . . Fx The number of math traces available depends on the software options loaded on your scope. See Specifications., and it exchanges the first two it finds whenever the button is pressed. Note that arrays of objects can be constructed, allowing numerous objects to be accessed in simple loops.

```
Private Sub Command1_Click()

Dim wm As Object
Set wm = CreateObject("LeCroy.XStreamApplication")

Set acq = wm.Acquisition ' To save typing
Set mat = wm.Math        ' To save typing
Dim t(16) As Object
' Create an array of objects to allow looping.
Set t(1) = acq.C1 : Set t(2) = acq.C2
Set t(3) = acq.C3 : Set t(4) = acq.C4
Set t(5) = mat.F1 : Set t(6) = mat.F2
Set t(7) = mat.F3 : Set t(8) = mat.F4
Set t(9) = mat.F5 : Set t(10) = mat.F6
Set t(11) = mat.F7 : Set t(12) = mat.F8

Dim trace As Integer
trace = 0: views = 0
' Exchange the traces on the grids.
Do
    trace = trace + 1
    If t(trace).View = "True" Then
        views = views + 1
        If t(trace).UseGrid = "YT1" Then
            t(trace).UseGrid = "YT2"
        Else
            t(trace).UseGrid = "YT1"
        End If
    End If
Loop Until ((trace = 12) Or (views = 2))
' Show the parity of the last swap.
If Command1.Caption = "Swap A" Then
    Command1.Caption = "Swap B"
Else
    Command1.Caption = "Swap A"
End If

Dim TextString As String
TextString = Text1.Text
Dim TextValue As Integer
TextValue = Val(TextString) + 1
TextString = Str(TextValue)
TextString = Trim(TextString)
Text1.Text = TextString

End Sub
```

This routine exchanges the first two traces that it finds. You can make it exchange all the traces on a dual grid by changing the penultimate line to this - Loop Until trace = 12

The next figure shows the Visual Basic Screen just after the Text Box text has been set to "0" in the Properties Window, thus defining the initial value.

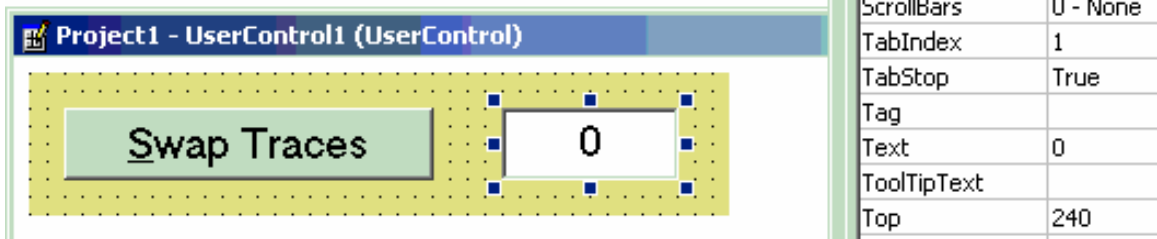

Here is the result after seven swaps. The counting method could be useful in any routine where numerous operations, such as triggers, have to be performed. In fact, the caption of the button could have been used to show the number of operations.

ActiveX offers a large range of standard controls, including list boxes for selection from a list, and picture boxes for drawing graphs and charts.

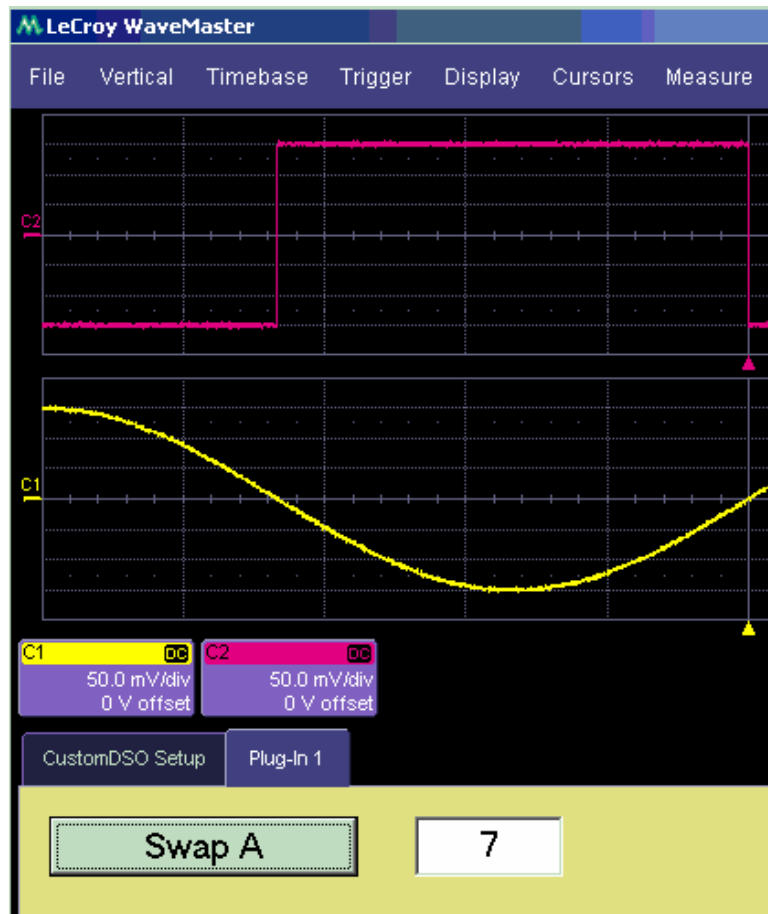

Second Example PlugIn - Log-Log FFT Plot

A frequent requirement is to plot a frequency spectrum on two logarithmic scales. The instrument provides a vertical scale, so CustomDSO has only to change the horizontal one. Here is an example. The first figure has been truncated on the right side.

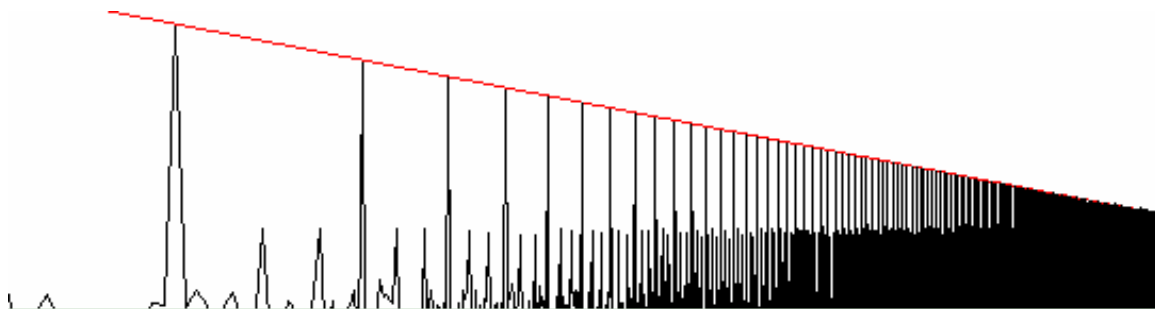
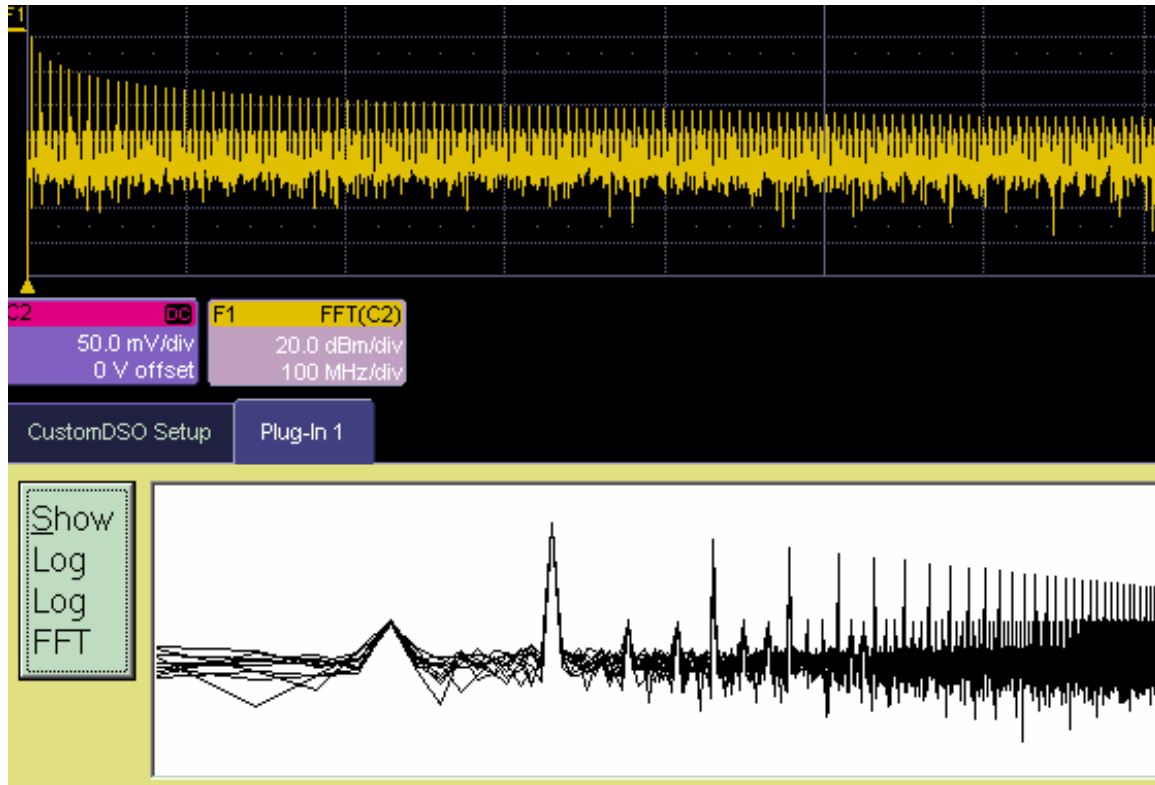

These examples were made with two different instrument setups: in the second, the FFT was zoomed vertically. The graph has a red line to represent the theoretical envelope for the peaks. This has great potential for testing the transmission characteristics of amplifiers and filters, since the output can be compared with a theoretical curve. Furthermore, if the output is divided by the

curve, the result for a perfect DUT would be a horizontal line, which is easy to inspect. The example below has been magnified vertically by a factor of ten. The rise at the right side occurs because the signal is descending into the noise.

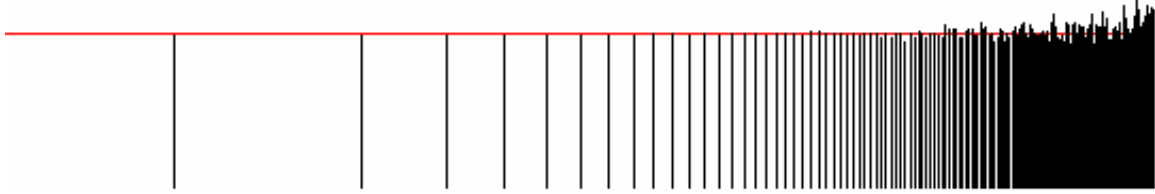

```
Private Sub Command1_Click()
' Draw a DSO trace on a logarithmic horizontal scale.
Dim WM As Object
Set WM = CreateObject("LeCroy.XStreamApplication")

Dim Samples As Long
Samples = WM.Math.F1.Out.Result.Samples
Samples = Samples - 1 ' Make it a round number.
' Calculate the horizontal scale.
LogSamples = Log(Samples)
XScale = Samples / LogSamples

' Set the scale using DSO variables
Dim Top, Bot As Single
Top = WM.Math.F1.Out.Result.VerticalFrameStop
Bot = WM.Math.F1.Out.Result.VerticalFrameStart
Picture1.Scale (0, Top)-(Samples, Bot)

Dim Wave
Wave = WM.Math.F1.Out.Result.DataArray

Dim Black, White, Blue, Red As Long
Black = 0: White = &HFFFFFF
Blue = &HFF4444: Red = &HFF

' Draw a theoretical curve for the peaks.
StartPoint = Top + 20#: EndPoint = -54.5
Picture1.Line (0, StartPoint)-(Samples, EndPoint), Red

' Draw the plot with linear interpolation between points.
For X = 1 To Samples
LogX = XScale * Log(X): Y = Wave(X)
If X > 1 Then
Picture1.Line (LogX, Y)-(OldLogX, OldWave), Black
```

```
End If  
OldLogX = LogX: OldWave = Y  
Next X
```

End Sub

Here is an example showing a simple one-pole roll-off compared to a curve.



Control Variables in CustomDSO

The simplest way to select variables for use in CustomDSO is to use LeCroy's X-Stream Browser.

LABNOTEBOOK

Introduction to LabNotebook

LeCroy's LabNotebook feature extends the documentation capabilities of your scope. It allows you to create an annotated notebook entry containing all displayed waveforms, the setup of the scope, and user-supplied annotation. The notebook entry can then be converted to hardcopy format -- pdf, rtf, or html -- and printed or e-mailed. You can also use the default report layout or configure your own, and even substitute your own company logo in the header.

Notebook entries are stored in an internal database and are available for recall at any time. Besides storing the waveform data, LabNotebook also stores your panel setups and parameter measurements. You have the capability to back up the database to external media.

The Flashback feature allows you to recall the state of the scope at a later date, including the saved waveforms and the scope setup, so that you can make additional measurements. A keyword filter makes it easy to find the correct notebook entry to recall.

You can choose which notebook to use for your entries, and label the notebook by project or user. If the scope is shared among several users, for example, or used for different projects, the data can be kept separately. Similarly, hardcopy reports can be stored in different folders.

Preferences

You should set your preferences before creating notebook entries.

Miscellaneous Settings



You can elect to name notebook entries with the default date and time by leaving the top box unchecked. Check the box if you want the opportunity to rename the notebook entry as soon as it is created.

Check the middle box if you want to be able to annotate a notebook entry as soon as it is created.

Check the last box if you want to generate a notebook entry by simply touching the Hardcopy (Print) front panel button



. By checking this box, you override any other configuration for this button; for example, send e-mail or output to printer.

Hardcopy Setup



Check the **Use Print Colors** checkbox to place your waveforms on a white background in the notebook entry. This will save printer ink later when you print the hardcopy report.

Touch inside **Hardcopy Area** to determine how much of the screen image to include in the report: grid area only, grid area plus dialog, whole screen.

E-mail Setup

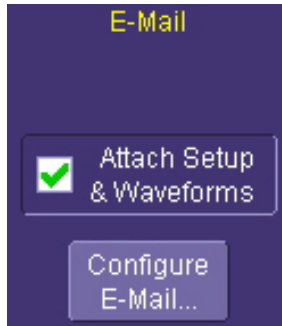

You can e-mail just the pdf or html report; or, you can include additional files: trace data (.trc) for each waveform in the report, a screen dump, a scope setup file, and an xml report record. Touch the checkbox to enable the extra report segments.

Touch the **Configure E-Mail** button to set the recipient address and server information.

Creating a Notebook Entry

1. Touch **File** in the menu bar, then **Create Notebook Entry** in the drop-down menu:

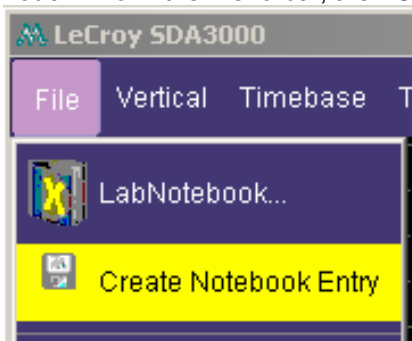

A dialog box is displayed in which to enter a title and comments for the entry. By default, the entry is titled with the current date and time:

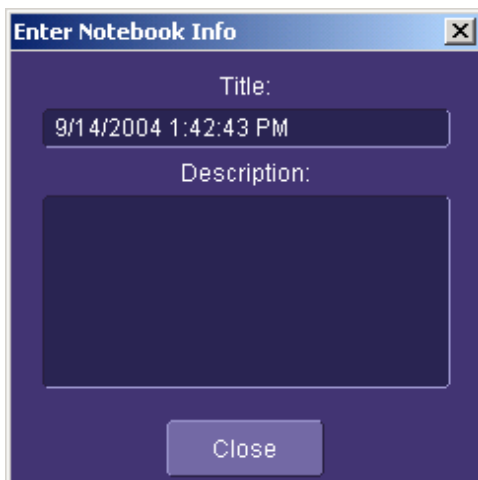

2. Touch inside the **Title** field and enter a title, using the pop-up keyboard. Then touch inside the **Description** field and enter a description, if desired, and touch **Close**.

The notebook entry will display your waveforms in "print colors," that is, on a white background to save printer ink, if you selected that option in notebook Preferences. Otherwise, the waveforms will appear on a black background. A drawing toolbar appears at top:



The pen tool enables you to write or draw in freehand. You can use a mouse, or a stylus to do this using the touch screen. Once you click off, you can drag your note anywhere on your waveform.



The circle tool enables you to create a circle around a waveform feature that you want to point out. Once you click off, the circle is drawn and you can drag it anywhere on the screen.



The arrow tool enables you to draw lines with arrowheads for callouts. You can rotate these lines through 360 degrees and drag them to any location on the screen.



The text tool enables you to enter text callouts on your report. When you touch this tool, a dialog box opens in which to enter text by means of a pop-up keyboard:



After you touch **Close**, your text will appear on the display as a draggable object.

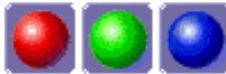

These are the three default colors that you can select for shapes, lines, and text. To use additional colors, touch **More**.

More

When you touch **More**, a Custom box opens with the default color yellow displayed. Touch the yellow button to open the full color palette:

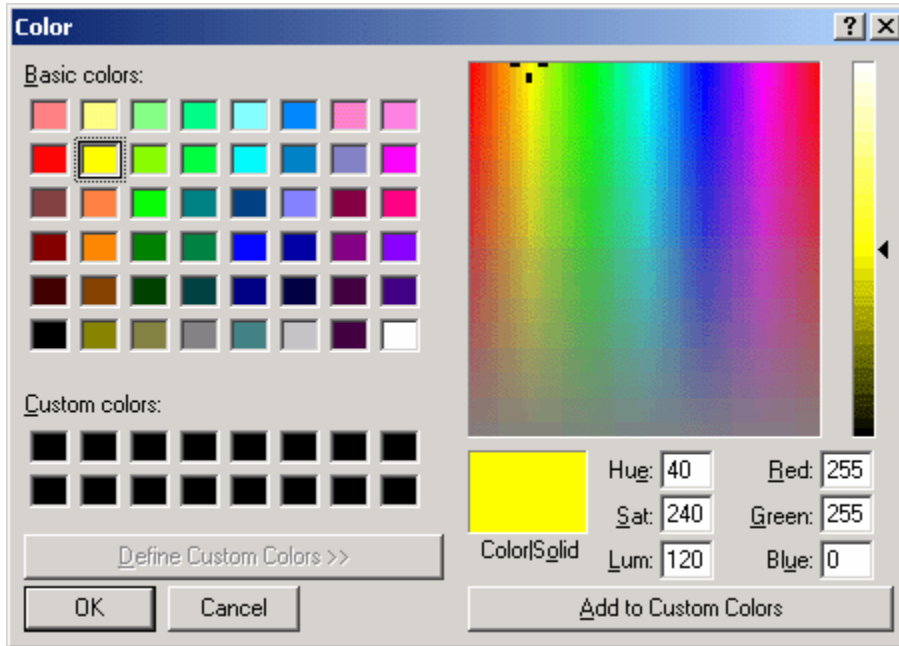

When you have chosen a custom color, touch **Add to Custom Colors**; the color will appear in the **Custom Colors** palette:

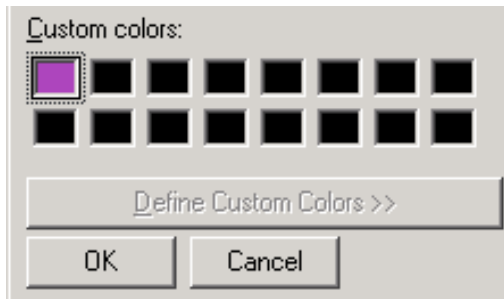

Then touch the color to enable it, and touch **OK**. The next object that you create will be in that color.

Erase Selected

If you want to erase a drawing object, touch it to select it, then touch **Erase Selected**.

Erase All

Touch **Erase All** to erase all drawn objects and text.



Touch **Undo** to discard the last object drawn.



The **Move Toolbar** button enables you to place the toolbar anywhere on the screen. Touch the button a second time to return it to its original fixed location.



Touch **Done** when you are finished annotating the notebook entry. The name of the entry will appear in the list box in the "LabNotebook" dialog. You can now create a hardcopy report of it, and email or print it out.

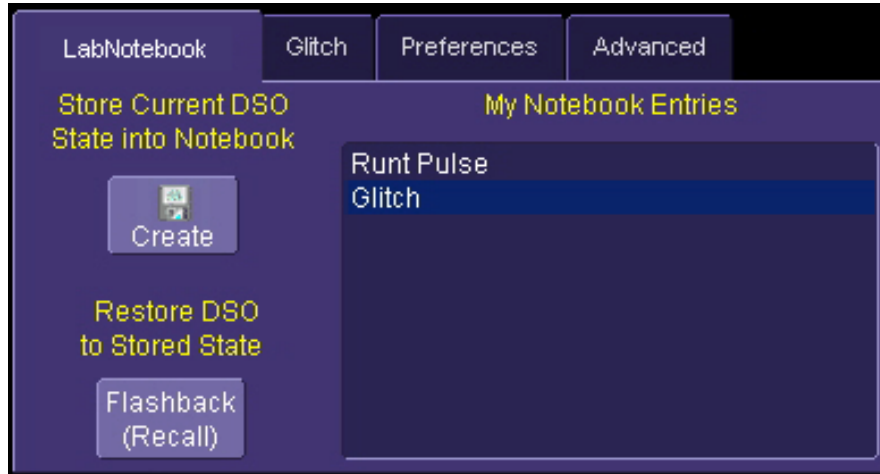

Recalling Notebook Entries

After a notebook entry is made, you can recall it at any time. The recall includes waveforms and scope settings.

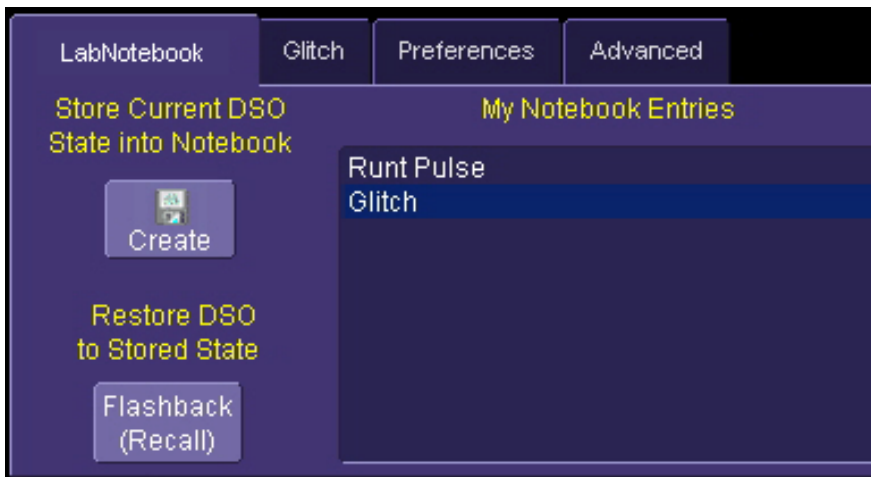

1. Select the notebook entry from the list box.
2. Touch Flashback.
3. To exit Flashback, touch the **Undo Flashback** button in the top-right corner of the screen, or press the **Auto** trigger button.

Note: The flashback feature currently recalls the scope setup, and all displayed waveforms. Some forms of 'result data' are not recalled, including:

- a. Persistence data. This will be saved in the hardcopy, and will be printed in the report, but will not be recalled during Flashback.
- b. Histogram data. Histograms internally have a 32-bit resolution, but when stored into a trace file and recalled during flashback they are clipped to 16-bits.
- c. Floating point waveforms. Certain math operations result in the creation of floating point waveforms with much higher resolution than can be stored in a 16-bit waveform file. This extra resolution will not be preserved when traces are recalled using flashback.
- d. Cumulative Measurements. Any measurements that are on when the Lab Notebook entry is created are not saved individually in the database, other than being embedded in the hardcopy image. This means that when flashback is used, the measurements will be recomputed using the waveform data that was recalled. Normally this will not pose a problem, but if cumulative measurements were on, which accumulated data from multiple acquired waveforms, they will lose their history and show instead only the results from the stored waveforms.

Creating a Report

Once the notebook entry is created, you can easily generate a hardcopy report for e-mailing or printing.

Previewing a Report

Before creating a report, you can preview it by simply touching the **View** button . To exit the preview, touch the **Close** button at the right of the dialog.

Locating a Notebook Entry

A search filter is provided to help you locate the notebook entry you want to make a report of. You can search by date or keyword.

Show only records created on this date

Day: 1 Month: 1 Year: 2004

Show only records containing this keyword

Keyword:

Cancel Find Now

1. Touch the **Filter** button . A search dialog box opens.
2. Touch inside the **Day**, **Month**, and **Year** fields and enter a date. Or touch inside the **Keyword** field and enter a keyword or phrase.
3. Touch **Find Now**. Only the entries fitting the date or keyword criteria will now appear in the list box.

Creating the Report

1. Select a notebook entry in the list box

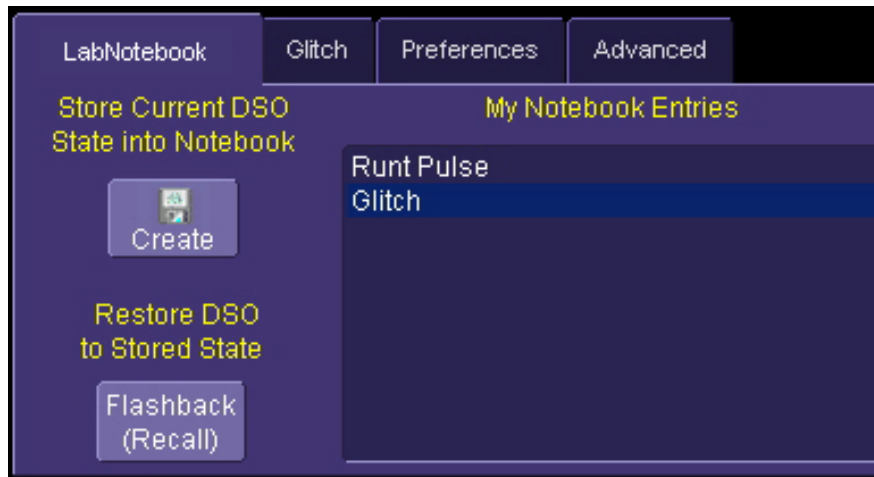

2. Touch inside the **Format** field and select a report format from the pop-up menu



3. Touch the **Create Report** button.
4. A dialog box opens in which to name the report and select a folder to contain the report. Touch inside the **File name** field and enter a name using the pop-up keyboard.
5. If you want to e-mail or print the data to a network printer, touch **More Actions**, then the **Print** or **E-Mail** button. If you select **Print**, a Windows dialog box will open for you to select a printer and set options. If you select **E-Mail**, the report will be sent immediately to the e-mail address configured in Utilities Preferences.

Formatting the Report

LeCroy provides a default report format (template); however, you can use your own format, including company logo.



1. Touch the **Advanced** tab.
2. Touch inside the **Directory** field and navigate to a folder to contain the reports.
3. Touch the **Browse** button next to Template to navigate to an existing report format that you want to use. Or touch inside the **Template** field and enter the name and path to the template, using the pop-up keyboard. Otherwise, touch the **Use Default** checkbox to use LeCroy's format.
4. To use a logo other than the one provided, which indicates the scope that produced the report, browse to the bit map file or touch inside the **Logo** field and enter the name and path to the file, using the pop-up keyboard. Otherwise, touch the **Use Default** checkbox to use LeCroy's logo:



Note: If you elect to use your own logo bit map, do not use a bit map larger than 180 pixels (height) x 100 pixels (width).



Managing Notebook Entry Data

Adding Annotations

You can add annotations to your notebook entry at any time.



1. Touch the "LabNotebook" tab.
2. Touch the notebook entry you want to annotate in the scroll list box. A new tab will appear bearing the name of the selected notebook entry.
3. Touch the new tab, then the **Scribble** button . The notebook entry will appear again with the drawing toolbar, described in Creating a Notebook Entry.

Deleting Notebook Entries

1. Touch the "LabNotebook" tab.
2. Touch the **Delete All** button  to clear the database, or Select a notebook entry in the list box, then touch the **Delete** button  to discard just that one entry.

Saving Notebook Entries to a Folder

You can save notebook entries to a folder other than the default.

1. Touch the tab bearing the name of the notebook entry.
2. Touch the **Save Data to** button . A navigation window opens, which provides the opportunity also to open Windows Explorer to navigate to the folder.
3. Touch the **Zip** checkbox  if you want to compress the data before archiving.

Managing the Database

You can begin a new database for your notebook entries at any time, back up the current one, or compress the data.

To Select a Database for Backup or Compression

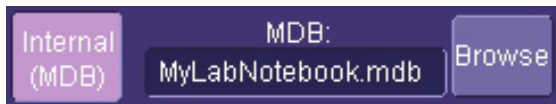

1. Touch the **Advanced** tab.
2. Touch the **Browse** button. A navigation window opens. Navigate to the database you want to work on



Compact

Touch **Compact** to reduce the size of a database. This function "defragments" the notebook after a large amount of entries have been deleted.



Backup

Insert a memory stick into a USB port, then touch **Backup** to send the database to the external media:

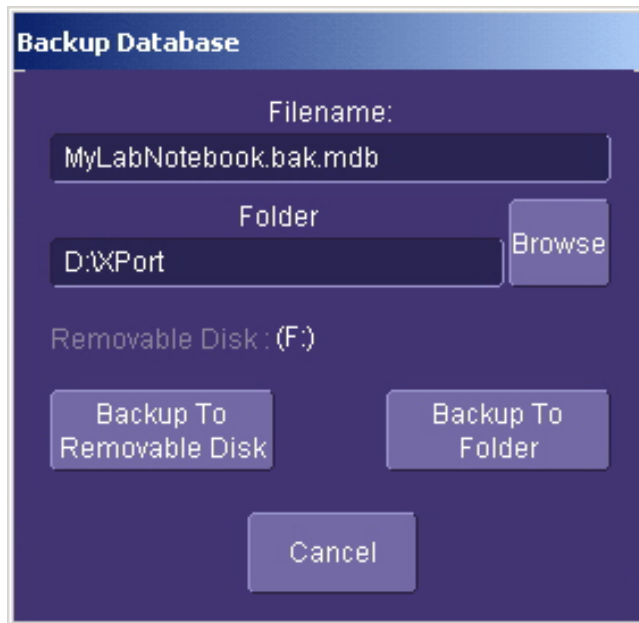

To Start a New Database

Touch the **Start New** button. The name of the notebook database will be incremented by 1:

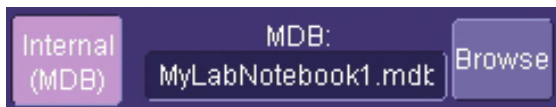

DDA

DDA Front Panel Controls

The front panel of the DDA is similar to that of other X-Stream scopes except for the substitution of

the Drive Analysis button  for the Default Setup button.

When you press the Drive Analysis button, you gain access to the Drive Analysis setup dialogs:

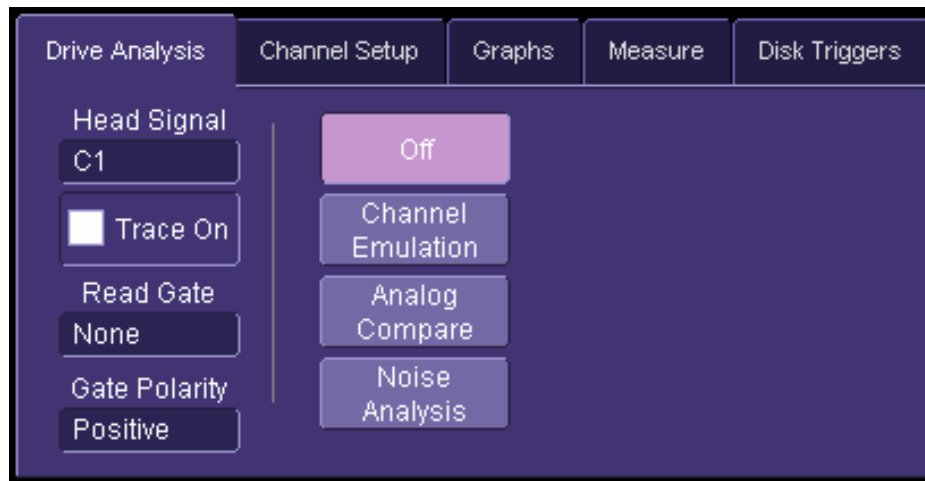

To recall the default setup on a DDA, press the Save/Recall front panel button, then select the "Recall Setup" tab and touch the **Recall Default Setup** button.

Note: You can also touch **File** in the menu bar, then **Recall Setup...** in the drop-down menu.

DDA Specifications

Additional DDA Triggers

Sector Pulse: Triggers on the n^{th} sector pulse (1 to 50) after index. Index and sector pulse polarity and sector pulse number are selectable.

Servo Gate: Triggers on the n^{th} servo gate after index and every m^{th} thereafter. Index and servo gate pulse polarity are selectable.

PES Trigger: Triggers on Position Error Signal (PES) exceeding an adjustable voltage window. Servo gate can be selected as qualifier.

Read Gate Trigger: Triggers on any read gate longer than an adjustable Sector ID field length (100 ns to 50 μ s).

Disk Drive Measurement Package (DDM2)

This package provides disk drive parameter measurements and related mathematical functions for performing disk drive WaveShape Analysis.

- Disk Drive Parameters:

amplitude symmetry	local time over threshold
auto correlation s/n	local time trough-peak
local base	local time under threshold
local baseline separation	narrow band phase
local maximum	narrow band power
local minimum	non-linear transition shift
local number	overwrite
local peak-peak	pulse width 50
local time between events	pulse width 50-
local time between peaks	pulse width 50+
local time between troughs	resolution
local time at minimum	track average amplitude
local time at maximum	track average amplitude-
local time peak-trough	track average amplitude+

- Correlation function
- Trend (datalog) of up to one million events
- Histograms expanded with 19 histogram parameters and up to 2 billion events

Automated DDA Measurements

ACSN	local time under threshold
local base	msnr
local baseline separation	m_to_r
local maximum	NLTS
local minimum	narrow band phase
local number	narrow band power
local peak-peak	overwrite
local time between events	pulse width 50
local time between peaks	pulse width 50-
local time between troughs	pulse width 50+
local time at minimum	resolution

local time at maximum	rsnr
local time peak-trough	track average amplitude
local time over threshold	track average amplitude-
local time trough-peak	track average amplitude+

Advanced DDA Analysis

- Head Filter/Equalizer Emulation
- Channel Emulation
- SAM Histograms
- Plot of SAM Values
- PES Runout Analysis
- Analog Compare
- Correlation
- Trend
- Histogram

Drive Analysis Overview

Obstacles that Can Be Overcome Using the DDA's Channel Analysis

Disk Drive engineers who are analyzing channels to determine where and why data errors occur face important obstacles. But the DDA's Channel Analysis feature can be used to overcome these obstacles.

Lack of Synchronization

The first obstacle is the lack of integration or synchronization between the computers used to identify and locate data errors, and the instruments that analyze the channel signals. It is, therefore, difficult to capture the signal that may be responsible for an error at the same point in time at which the error occurs. If an error is repetitive, its signal can be captured and viewed. But if the error is intermittent, capturing it at the correct time may be impossible.

Unknown Sectors

Another obstacle is that the data written to a particular sector may not be known. And because no reference is available, the exact location of an error in a particular sector cannot be determined. In order to have a known data set, data may subsequently be written to the sector concerned. Nevertheless, there is no guarantee that this will recreate the error. For many, writing to a sector with errors is the last resort.

Problematic PRML

Another problem is the difficulty of analyzing partial response maximum likelihood (PRML) head signal quality and identifying both the problem locations and the margin available before errors

occur. Head signals for PRML channels have complex waveshapes, which are very difficult or even impossible to analyze by visual inspection. Analysis of these signals with an oscilloscope is often limited to looking for gross abnormalities such as significant thermal asperities or dropouts of sufficient duration. Furthermore, because of the sophistication of PRML signal processing, even some visible anomalies may not necessarily cause an error.

Time and Effort

Lastly, data in the sectors is complex and lengthy, and it can take significant time and effort to scroll through and visually inspect signal locations. The problem is of data presented in a time-linear fashion, rather than in the order of signal areas most deficient in PRML channel related signal integrity.

In an integrated environment, the Channel Analysis feature analyzes the head signal. Designed to overcome the obstacles just described, it combines powerful analytical tools with the ability to capture and analyze the head signal in a synchronized way.

What Channel Analysis Provides

The DDA's Channel Analysis feature provides insight into channel data quality and errors, even while data is being processed through the channel. It can also do the following:

- Filter and display the head signal with automatic or selectable settings for -3dB cutoff and boost
- Select head signal sections to be viewed by byte number
- Provide a display of PRML target levels annotated on the head signal trace to provide an intuitive visual indication of head signal quality
- Identify head signal locations of the poorest quality from a PRML standpoint, quantify the quality of the signal at these locations, and display in order of poorest quality the head signal location and the byte number of each error
- Identify areas where two head signal differences are greatest and provide a benchmark for the difference and the byte locations where these occur

The Channel Analysis feature can be operated in either of these basic modes:

- Channel Emulation
- Analog Compare

Because each requires a similar setup, both share the same Channel Setup menu system, which lets you switch between modes without the need to redefine setup details.

Channel Emulation

Often when examining a partial response maximum likelihood (PRML) data signal, it may be desirable to view those signal locations where the quality is poorest and the signal is likely to be the most problematic for a PRML channel.

Channel Emulation enables analysis of PRML head signal quality from the point of view of the PRML channel. This is made possible by the emulation of PRML channel processing by means of

signal equalization, automatic gain control (AGC), phase lock loop (PLL), sampling, and Viterbi detection.

For each PRML sample, a quality sequenced amplitude margin (SAM) benchmark is determined. The lower the value of SAM the greater the difficulty for the drive channel to produce the right data value for that sample, and the less margin there will be. A SAM value of less than zero indicates that an incorrect data value will be selected at that sample.

PRML signals characteristically have a set of target-level values that the signal samples should meet at the sampling times. For example, for a PR4 signal, the targets are **1 0 -1**. In order to achieve these desired levels, the DDA's channel emulation equalizes the head signal, either automatically or using selected values for -3 dB cutoff and boost. The equalized head signal is then displayed. This lets you examine the head signal after it is processed, when it will have the characteristic PRML waveshape.

The distance of the waveform samples from the PRML target values is a first-order indication of the quality of a PRML signal. The channel emulation annotates the head signal after equalization with the target values. This makes visual interpretation of the quality of the head signal possible and intuitive. As a result, you can visually inspect the head signal to an extent beyond the more obvious indications of problems such as thermal asperities and dropouts.

In addition, several powerful ways are available for selecting how the section of the equalized, annotated head signal will be viewed:

- You can scroll through the head signal in the traditional time sequential mode using the Auto Scroll feature, which provides "hands free" scrolling at a rate and in the direction that you specify.
- You can select which part of the head signal is to be displayed by byte number. This is particularly useful if a data error is known to exist at a particular byte location.
- You can review the head signal in order of poorest SAM value. This capability is particularly practical because the areas of poorest quality are generally of greatest interest.

The ways in which Channel Emulation can be operated are with or without a reference signal, and Stop on SAM (on/off).

With or Without Reference

Using a reference head signal, where available, provides two major benefits. First, the head signal under analysis can be viewed with a head signal that has a reference for improved interpretation of waveform misshapes. The DDA will equalize both reference and head signals. It will also auto-align the two signals when selecting the head signal to be viewed by SAM --- even if they were captured at different spindle speeds (up to 1%).

An additional benefit is that the SAM calculation can then assume values less than zero and indicate a data error likely at that point. Without a reference signal, it would be impossible to determine whether an error occurs for a particular sample, only the confidence (SAM) of the Viterbi detector in selecting between a data '1' or data '0' for a particular sample. In this case, the minimum confidence level possible is zero SAM, indicating no confidence in making a selection. The correct data can be specified with a reference, which allows SAM values of less than zero to be detected

when the signal quality is so poor that an incorrect data value would be selected by the DDA's Viterbi detector.

Stop On SAM

The second selection mode of operation is Stop on SAM. When this mode is enabled, the DDA is placed in what is essentially a test mode for PRML signal quality based on SAM. When in Normal acquisition mode, the DDA will continuously acquire and analyze head signals until it finds a PRML sample value with a SAM value below a user-specified level. When this occurs, acquisition will be stopped, and the user can directly view the locations below the selected SAM threshold. This mode of operation is particularly useful for capturing intermittent errors.

Analog Compare

Often the head signal locations requiring examination are a header or other non-PRML data section. You may wish to compare these signal sections to a reference signal in order to obtain visual clues to possible problems. However, several issues may have to be addressed before this can be done.

The reference and head signals might differ in time due to spindle speed variations. This could make alignment and comparison of the two signals difficult.

Another issue is that differences may be so subtle that they are not very apparent --- especially so if the signals being compared are lengthy.

A third issue is that the problem may be intermittent.

What is generally required for addressing all three issues is an automatic comparison method that adjusts for spindle speed variations and identifies where the two signal differences are the greatest. In the case of intermittent problems, comparisons should be made continuously until a difference greater than a selected threshold is seen. This is just what the Analog Compare feature provides.

With Analog Compare, you select a head signal to act as the reference, and it gets stored in memory. The maximum allowable difference between the two signals is then selected. Analog Compare automatically aligns the two signals and identifies where a mismatch occurs. It also counts each mismatch, storing its byte location for further review. Up to 100 mismatches can be identified and stored in largest-to-smallest order.

As a general-purpose test method, Analog Compare can be applied to finding problems in practically any signal, including other head signals.

General Steps of Analog Compare

1. **Tell the DDA the signals you are providing:** Identify in the Channel Setup the signals that are being provided and their source --- the particular input channel or memory. Also identify the section of the head signal you want analyzed.
2. **Set up the channel characteristics:** Each of the Channel Analysis methods has a required set of head signal characteristics that need to be provided in order to perform the necessary analysis. These may include bit cell time, code rate, PRML type, and other characteristics.
3. **Select a channel analysis method:** Specific configuration requirements differ depending on the method used. See "Setting up for Using Drive Channel Analysis" in the Disk Drive

Analyzer Reference Manual for more information.

4. **Turn on and configure the method selected:** Once a channel analysis method is selected, it needs to be configured and turned on.
5. **Review the problems the DDA identifies:** Review the head signal areas that the DDA identifies as having the poorest quality or differences from a reference. If the method selected is Channel Emulation with Stop on, SAM on, or Analog Compare, head signal sections that exceed a user-specified threshold will be displayed. If no sections exceed the selected threshold, it may be desirable to adjust the threshold until violations are identified.

Head Signal Filtering

When you are visually analyzing or measuring a servo head signal, it is usually desirable to first filter the head signal to remove noise. In addition, if boost is provided in the servo system, adding the corresponding boost to the displayed or measured head signal may also be beneficial. This allows analysis of the head signal as the servo processing system sees it.

The ability to set values for the -3 dB cutoff, boost and group delay is provided by this Servo Analysis feature. In addition, the filter provided can be easily set up to view or measure any head signal.

Analog Compare

When you are attempting to locate a problem in a wedge signal, for example, the same complications are encountered as with Channel Analysis --- with similar solutions.

Noise Analysis

Disk noise parameters enable parameter measurements of media signal-to-noise (msnr), residual (electronics) signal-to-noise (rsnr), and the ratio of media to residual signal-to-noise (m_to_r). The calculation of all three parameters is based on the distribution of the averaged Viterbi input samples.

- **msnr** can be applied to any single-frequency, sector-based data pattern. The single-frequency data will be sampled at the peaks (maxima), zero crossings, and troughs (minima). Any deviations from the ideal sample points will be a result of noise. By performing multiple reads, random noise can be averaged away. With this measurement, the repeating media noise level can be derived by msnr.
- **rsnr** can be applied to any single-frequency, sector-based data pattern. The single-frequency data will be sampled at the peaks (maxima), zero-crossings, and troughs (minima). Any deviations from the ideal sample points will be a result of noise. By performing multiple reads, random noise can be quantified. With this measurement, the non-repeating residual (electronics) noise level can be derived by rsnr.
- **m_to_r** can be applied to any single-frequency, sector-based data pattern. The msnr is compared with the rsnr. The resulting ratio indicates whether the signal is dominated by media noise if it is greater than 1.00, or dominated by residual (electronics) noise if less than 1.00.

Measure's Drive Parameters

The buttons accessed via the "Measure" tab allow quick and convenient setup of the most common sets of measurements made on a head signal. These include:

- Track Average Amplitude (TAA), PW50
- Amplitude Asymmetry, PW50+, PW50-, Baseline Separation, and TAA
- Auto-Correlation Signal-to-Noise (ACSN)
- Non-Linear Transition Shift (NLTS)
- Jitter (period at level)

Setting Up Channel Emulation

Drive Analysis Setup



1. Press the DDA's front panel Drive Analysis button . The disk drive dialogs appear.
2. Touch the **Drive Analysis** tab

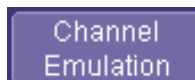
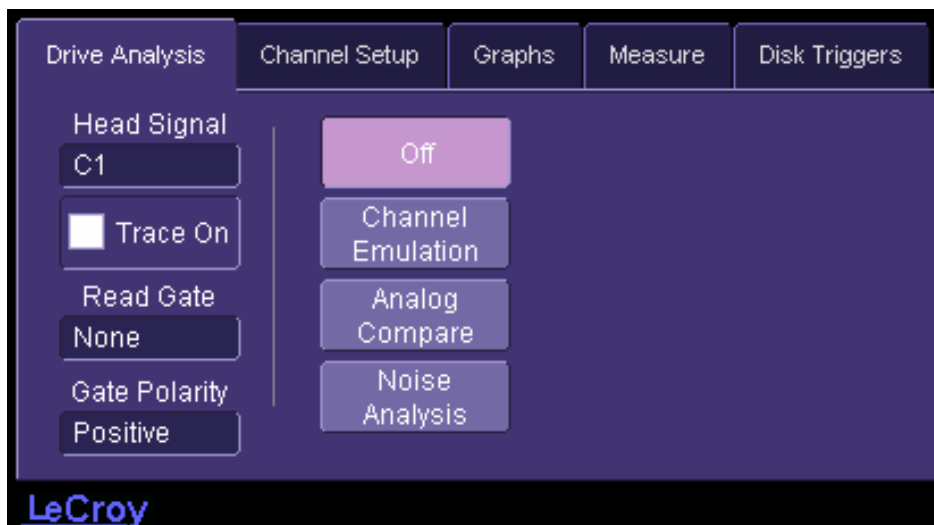

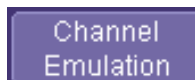
3. Touch the **Channel Emulation** button . The Channel Emulation setup checkboxes, buttons, and data entry fields appear.
4. Touch inside the **Head Signal** field and select a signal source from the pop-up menu. The choices comprise channel inputs C1-C4, math traces F1-F8, memories M1-M4, or Reference. See Channel Emulation with Reference and Channel Emulation without

Reference for guidelines on using a Reference.

5. Touch the **Trace On** checkbox to turn the Head Signal on.
6. Touch inside the **Read Gate** field and select a source from the pop-up menu. The choices include **Ref** and **none**. Read Gate If the Read Gate signal is connected to a DDA-5005A channel and specified, it will be used to determine the regions of the signal to be analyzed. Since the **VCO Synch** field is required for Channel Emulation with Reference and is normally present in the head signal in every block just after Read Gate goes true, it is recommended that Read Gate be used. If Read Gate is not present, the entire waveform will be used unless the Analyze Region cursors are enabled.
7. If for Read Gate you selected other than **none**, Touch inside the **Gate Polarity** field and select positive or negative polarity.
8. Touch inside the Compare to Reference checkbox to enable comparison of the Head Signal to the Reference. Then touch the **Store Reference** button.
9. Touch the **Stop on SAM** checkbox if you want to stop the acquisition when the signal falls below a user-defined SAM value. Stop on SAM When this mode is enabled, the DDA-5005A is placed in what is essentially a test mode for PRML signal quality based on SAM. When in Normal acquisition mode, the DDA-5005A will continuously acquire and analyze head signals until it finds a PRML sample value with a SAM value below a user-specified level. When this occurs, acquisition will be stopped, and you can directly view the locations below the selected SAM threshold. This mode of operation is particularly useful for capturing intermittent errors.
10. Touch inside the **SAM Threshold** data entry field and enter a value from 0 to 2 , using the pop-up numeric keypad. See SAM in "PRML Channel Emulation" then touch **Back**  to complete this setup.
11. Touch the **Show ML Markers** checkbox to enable the markers. ML Markers The ML Markers indicate the location of the ideal PRML sample values based on the DDA-5005A's channel emulation.
12. Touch the **Show Level Markers** checkbox to enable the markers. Level Markers The Level Markers indicate the vertical position of the PRML levels based on the amplitude of the acquired PRML signal. The Level Markers indicate the vertical position of the PRML levels based on the amplitude of the acquired PRML signal. They reflect the levels at the center of the display.
13. Touch the **Specify Region** checkbox to specify a start and end time, if desired. This may be necessary if you are not using a Read Gate. If you are not using Read Gate, the Analytical Region must start with a preamble for VCO synchronization. Touch inside the Start and End data entry fields and enter starting and ending time values from -1.0 ks to +1.0 ks, using the pop-up numeric keypad.
14. To jump to a position in the head signal, touch inside the "Position" **Segment** field and enter a value from 1 to 999, using the pop-up numeric keypad. Then touch inside the **Byte** field and enter a value from 50 to 50,000.

15. To jump to a "worst SAM" area, after channel emulation, touch inside the **Worst Error #** field and enter a value from 1 to 100, using the pop-up numeric keypad.

Channel Setup

1. Touch the **Channel Setup** tab:

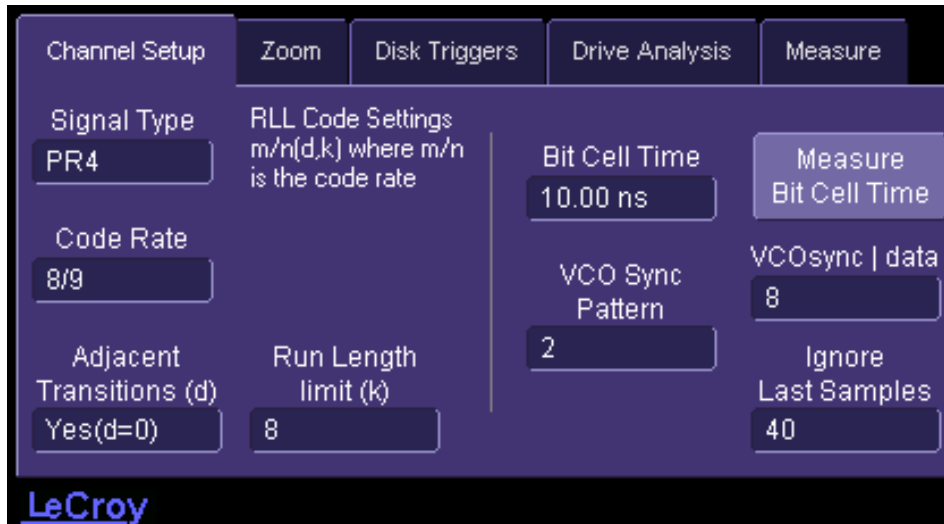

The Channel Setup buttons and data entry fields appear.

2. Touch inside the **Signal Type** field and make a selection from the pop-up menu:

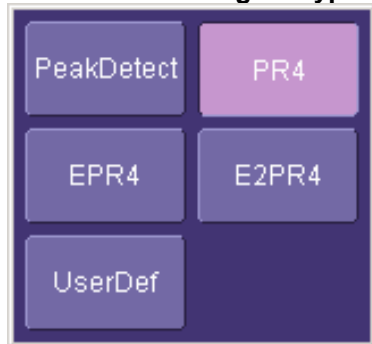

3. Touch inside the **Code Rate** field and make a selection from the pop-up menu:

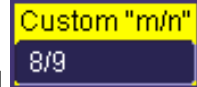
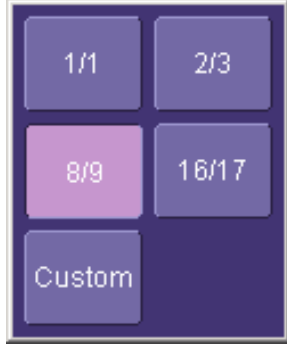

If you select **Custom**, also touch inside the **Custom m/n** data entry field and enter new m and n values, using the pop-up keyboard. See PRML Encoding in "PRML



Channel Emulation" then touch **Back** **Back** to complete this setup.

4. Touch inside the **Adjacent Transitions (d)** field and make a selection from the pop-up menu:

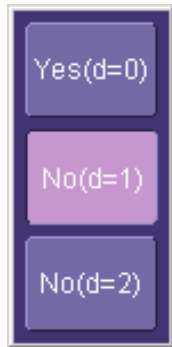



In general, PR4 and EPR4 use $d=0$; 2/3(1,7) encoded E2PR4 uses $d=1$.

5. Touch inside the **Run Length Limit (k)** field and enter a value from 0 to 99 using the pop-up numeric keypad.
6. Touch inside the **Bit Cell Time** field and enter a value from 1.00 ns to 1.00 μ s using the pop-up numeric keypad. Then press the **Measure Bit Cell Time** button. See Principle of



Equalization in "PRML Channel Emulation" then touch **Back** **Back** to complete this setup.

7. Touch inside the **VCO synch | data** field and enter a value from 1 to 32 using the pop-up numeric keypad.

8. Touch inside the **Ignore Last Samples** field and enter a value from 0 to 999.
9. Touch the **Filter head signal** checkbox to enable filtering of the head signal; then touch the **Train Filter** button to automatically set up equalization on the currently acquired head signal. See Train Filter in "PRML Channel Emulation" then touch **Back**  to complete this setup. If you do not automatically train the filter, you need to perform steps 10 and 11 to manually set up the equalization filter.
10. Touch inside the **3 dB Frequency** field and enter a value from 1.0 MHz to 800 MHz using the pop-up numeric keypad. See 3 dB Frequency in "PRML Channel Emulation" then touch **Back**  to complete this setup.
11. Touch inside the **Boost** field and enter a value from 0 to 13 dB using the pop-up numeric keypad. See Boost at fc in "PRML Channel Emulation" then touch **Back**  to complete this setup.
12. Touch inside the **Group Delay** field and enter a value from 30.0% to +30.0% using the pop-up numeric keypad. See Group Delay in "PRML Channel Emulation." This parameter is not set by the "Train Filter" function.

Setting Up Analog Compare

Drive Analysis Setup

1. Press the DDA's front panel Drive Analysis button . The disk drive dialogs appear.
2. Touch the **Drive Analysis** tab:

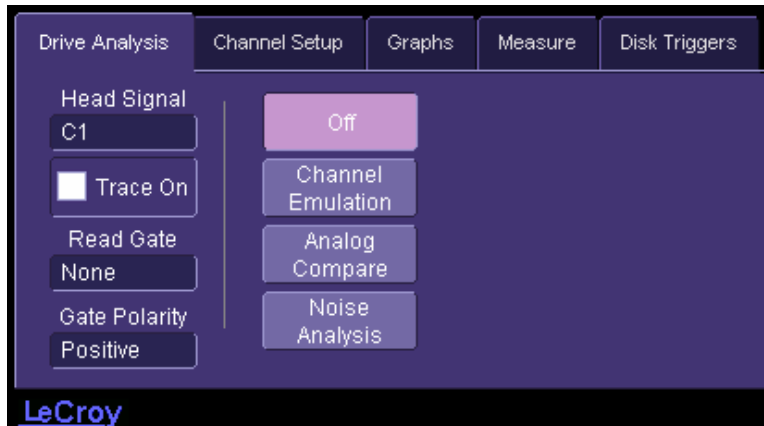



3. Touch the **Analog Compare** button. The Analog Compare setup checkbox, buttons, and data entry fields appear.
4. Touch inside the **Head Signal** field and select a signal source from the pop-up menu. The choices comprise channel inputs C1-C4, math traces F1-F8, memories M1-M4, or Reference. See Using Analog Compare for guidelines on using a Reference.
5. Touch the **Trace On** checkbox to turn the Head Signal on.
6. Touch inside the **Read Gate** field and select a source from the pop-up menu. The choices include **Ref** and **none**. Read Gate If the Read Gate signal is connected to a DDA-5005A channel and specified, it will be used to determine the regions of the signal to be analyzed. If Read Gate is not present, the entire waveform will be used unless the Analyze Region cursors are enabled.
7. If for Read Gate you selected other than **none**, Touch inside the **Gate Polarity** field and select positive or negative polarity.
8. Touch the **Store Head Reference** button.
9. Touch the **Specify Region** checkbox to specify a start and end time, if desired. (This may be necessary if you are not using Read Gate. If you are not using Read Gate, the Analysis Region must start with a preamble for VCO synchronization.) Then touch inside the **Start** and **End** data entry fields and enter starting and ending time values from -1.0 ks to +1.0 ks, using the pop-up numeric keypad.
10. To jump to a position in the head signal, touch inside the "Position" **Segment** field and enter a value from 1 to 999, using the pop-up numeric keypad. Then touch inside the **Byte** field and enter a value from 50 to 50,000.
11. Touch inside the **Worst Error #** field and enter a value from 1 to 100, using the pop-up numeric keypad.
12. Touch inside the **Analog Threshold** field and enter a value from 0 mV to 1 V.

Channel Setup

Channel Setup is required for Analog Compare, which is the same as for Channel Emulation.

Setting Up Noise Analysis



1. Press the DDA's front panel Drive Analysis button. The disk drive dialogs appear.
2. Touch the **Drive Analysis** tab:

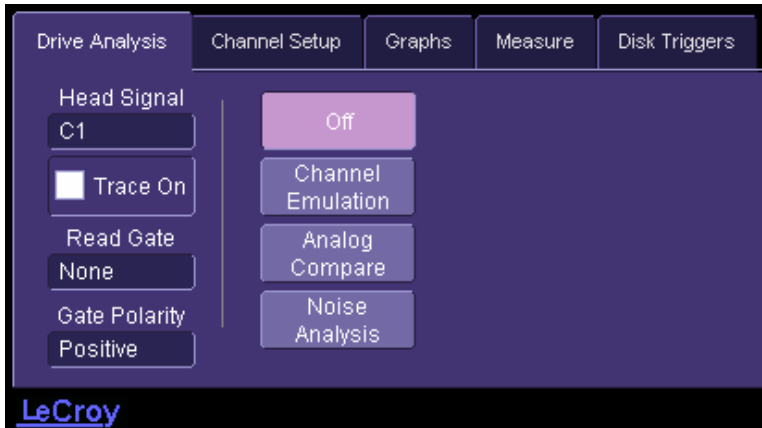

3. Touch the **Noise Analysis** button. The Noise Analysis setup checkbox, buttons, and data entry field appear.
4. Touch inside the **Head Signal** field and select a signal source from the pop-up menu. The choices comprise channel inputs C1-C4, math traces F1-F8, memories M1-M4, or Reference.
5. Touch the **Trace On** checkbox to turn the Head Signal on.
6. Touch inside the **Read Gate** field and select a source from the pop-up menu. The choices include **Ref** and **none**. Read Gate If the Read Gate signal is connected to a DDA-5005A channel and specified, it will be used to determine the regions of the signal to be analyzed. Since the **VCO Synch** field is required for Noise Analysis with Reference and is normally present in the head signal in every block just after Read Gate goes true, it is recommended that Read Gate be used. If Read Gate is not present, the entire waveform will be used unless the Analyze Region cursors are enabled.
7. If for Read Gate you selected other than **none**, Touch inside the **Gate Polarity** field and select positive or negative polarity.
8. Touch the **Setup for Single Frequency** button. This action automatically selects parameters **msnr**, **rsnr**, and **m_to_r** as **Source1** in "Measure" dialog positions P1 to P3, respectively. **ParamPassThru** is the **Measure** selection made for each, which means that the output is the same as the input.
9. Touch the **Avg. Samples** checkbox to enable averaging.
10. Touch inside the **Max Averages** data entry field and enter a value from 1 to 32,000 using the pop-up numeric keypad. Then touch the **Reset Average** button to clear the previous average.



Setting Up Disk Triggers

Read Gate

Read Gate triggers on a pulse of a specified minimum width on the Read Gate source. To set it up, proceed as follows:

1. Press the DDA's front panel Drive Analysis button . The disk drive dialogs appear.
2. Touch the **Disk Triggers** tab.



3. In the "Disk Trigger Types" menu , touch **Read Gate**. The Read Gate data entry fields appear. See Read Gate in "Channel Analysis Concepts" then touch **Back**  to complete this setup
4. Touch inside the **Minimum Width** data entry field and enter a value from 100 ns to 100 μ s.
5. Touch inside the Read Gate **Source** field and select an input channel or external source from the pop-up menu.
6. Touch inside the Read Gate **Polarity** field and select positive or negative polarity from the pop-up menu.
7. Touch inside the Read Gate **Level** field and enter a value, using the pop-up numeric keypad.

Sector Pulse

Sector Pulse triggers on the specified (n^{th}) sector start pulse after the Index mark. To set it up, proceed as follows:

1. Press the DDA's front panel Drive Analysis button . The disk drive dialogs appear.
2. Touch the **Disk Triggers** tab.
3. In the "Disk Trigger Types" menu, touch **Sector Pulse**. The Sector Pulse data entry fields appear. See Sector Pulse in "Setting Up to Use Drive Channel Analysis" then touch **Back**



Back to complete this setup.

4. Touch inside the **Trigger On Sector x after Index** data entry field and enter a value from 0 to 999 using the pop-up numeric keypad.
5. Touch inside the Sector Pulse **Source** field and select an input channel or external source from the pop-up menu.
6. Touch inside the Sector Pulse **Polarity** field and select positive or negative polarity from the pop-up menu.
7. Touch inside the Sector Pulse **Level** field and enter a value from 250 mV to 250 mV using the pop-up numeric keypad.
8. Touch inside the Index **Source** field and select an input channel or external source from the pop-up menu.
9. Touch inside the Index **Level** field and enter a value from 250 mV to 250 mV using the pop-up numeric keypad.

Servo Gate

Servo Gate triggers on all or selected Servo Gate pulses starting after the Index mark. To set it up, proceed as follows:



1. Press the DDA's front panel Drive Analysis button . The disk drive dialogs appear.
2. Touch the **Disk Triggers** tab.
3. In the "Disk Trigger Types" menu, touch **Servo Gate**. The Servo Gate data entry fields appear.
4. Touch inside the **After index wait x servo gates** field and enter a value from 0 to 999 using the pop-up numeric keypad.
5. Touch inside the **then skip x gates between triggers** field and enter a value from 0 to 999 using the pop-up numeric keypad.
6. Touch inside the Servo Gate **Source** field and select an input channel or external source from the pop-up menu.
7. Touch inside the Servo Gate **Polarity** field and select positive or negative polarity from the pop-up menu.
8. Touch inside the Servo Gate **Level** field and enter a value from 250 mV to 250 mV using the pop-up numeric keypad.
9. Touch inside the Index **Source** field and select an input channel or external source from the pop-up menu.

10. Touch inside the Index **Level** field and enter a value from 250 mV to 250 mV using the pop-up numeric keypad.

Setting Up Zoom

You can zoom on a particular segment and byte of your signal as follows.

1. Press the DDA's front panel Drive Analysis button:



The disk drive dialogs appear.

2. Touch the **Zoom** tab.
3. Touch inside the Position **Segment** data entry field and enter a value from 1 to 999 using the pop-up numeric keypad.
4. Touch inside the Position **Byte** field and enter a value from 50 to 50,000 using the pop-up numeric keypad.
5. If you want to increase or decrease your horizontal or vertical zoom in small increments, touch the **Var.** checkbox in the right-hand dialog to enable variable zooming. Now with



each touch of the zoom control buttons, the degree of magnification will change by a small increment. To zoom in or out in large standard increments with each touch of the zoom control buttons, leave the **Var.** checkbox unchecked. To set exact horizontal or vertical zoom factors, touch inside the Horizontal **Scale/div** data entry field and enter a time-per-div value, using the pop-up numeric keypad. Then touch inside the Vertical **Scale/div** field and enter a voltage value.

6. To reset the zoom to x1 magnification, touch **Reset Zoom** in the dialog or press the front panel zoom button:



DDA REFERENCE INFORMATION

Channel Analysis Concepts

The purpose of Channel Analysis is to find signal quality problems in the head signal. Thus both methods used by the DDA --- Channel Emulation and Analog Compare --- require that you first specify the DDA channel or memory on which the head signal is to be carried.

The instrument utilizes the head signal and, optionally, the Read Gate and the Analyze Region cursors to determine which part of the head signal will be analyzed. What follows is an explanation of how the instrument does this and the manner in which it processes the head signal.

The following figure shows the fields of the head signal and their relationship to Read Gate.

Head Signal Fields and Read Gate

In a normally operating disk drive, every time Read Gate goes true (at the beginning of every segment to be read) there must be a repetitive signal called the VCO Synch (voltage-controlled oscillator). It is needed to adjust the phase of the PLL (phase locked loop), which generates the sampling clock, and to adjust the AGC (automatic gain control).

The DDA will try to identify the VCO Synch signal in a similar fashion in order to perform channel emulation. In order to identify VCO Synch, you will need to provide a Read Gate signal or to set the Analyze Region cursors (see *Selecting the Waveform Section to be Analyzed*). After the DDA analyzes the VCO Synch signal, it is ready to analyze the data field for problems. Since the data field generally does not start immediately after the end of the VCO Synch field, the DDA needs to know where the data field starts. You must specify the number of bytes between the VCO Synch field and the data field. The DDA can then determine the location of the first byte of data.

If the channel analysis method selected is **Channel Emulation**, the DDA will perform PRML channel emulation to determine the location of problems in the data field. Often, there is a delay between the end of valid data and the disabling of the Read Gate. It is generally not meaningful to analyze this area of a sector for problems. In order to avoid analyzing this area, you can specify the number of PRML samples between the end of valid data and Read Gate being disabled in the **Ignore Last Samples** data entry field in the "Channel Setup" dialog.

Using the DDA's Equalization Filter

Disk drives generally have filters to remove noise and to shape the head signal. Without these filters, data would not be properly recovered. The DDA provides a similar filter capability. The equalization filter available in the instrument's channel emulation can be used with all the channel analysis methods to clean up and shape the signal, much like the channel chip will do.

It is recommended that unless the head signal has been equalized before being acquired by the DDA, the filter should be applied. Otherwise false problems may be reported. If you have access to the equalized signal from the drive, this signal can be provided to the DDA. The filter should not be used in this case. The following figure shows the same signal before and after using the DDA's filter.

Before and after filtering

As you can see, it would be very difficult to perform meaningful analysis of the "before" picture, because of noise. Note that Maximum Likelihood (ML) Markers ("+" signs) and Level Markers

(horizontal lines) are displayed in the "after" picture. The ML Markers indicate the location of the ideal PRML sample values based on the DDA's channel emulation. The Level Markers indicate the vertical position of the PRML levels based on the amplitude of the acquired PRML signal.

Selecting the Waveform Section to Be Analyzed

For the Analog Compare and Channel Emulation channel analysis methods, you can specify selective areas of the head signal for analysis by using the Analyze Region cursors or the drive's Read Gate signal, or both.

As discussed above, it is important for the DDA to be able to analyze the VCO Synch signal at the beginning of the region it is analyzing. If Read Gate is used to determine which head signal sections to analyze, this will not be a problem, since the DDA will use Read Gate to identify the location of VCO Synch. If Read Gate is not used, it is important, by means of the Analyze Region cursors, that the beginning of the head signal section analyzed be very near the beginning of VCO Synch.

The following figures show the areas of the waveform to be analyzed, with the different combinations of the Analyze Region cursors or Read Gate, or both, enabled. The Analyze Region cursors, if enabled, generally specify the outer-most boundaries of the data to be analyzed. They are particularly useful if Read Gate is not available or if only a subset of several Read Gate true sections captured is to be analyzed --- for example, a single sector within several captured, or excluding the ID field. Within the area designated by the markers, if Read Gate is specified, only the regions of the Head Signal during which Read Gate is true are analyzed (as shown in Case 1) while all others are ignored.

Case 1: Only Read Gate True regions are analyzed

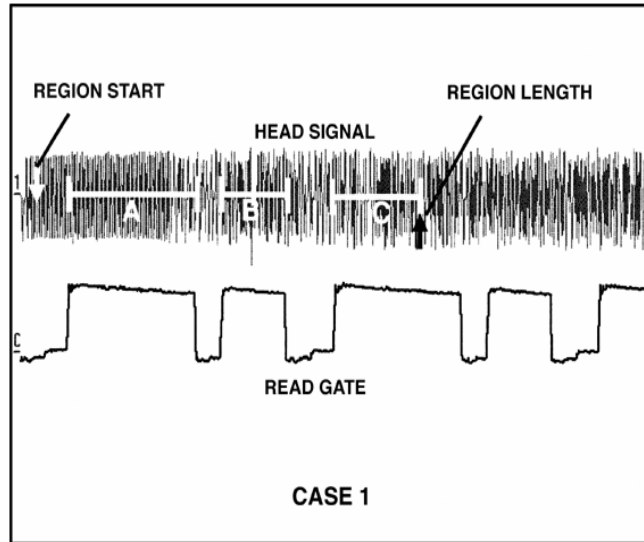

Similarly, if Analyze Region is disabled and Read Gate enabled, the area of the Head Signal during which Read Gate is true is analyzed, as shown in sections A, B, C, D, and E in Case 2

Case 2: Head Signal Read Gate True regions analyzed

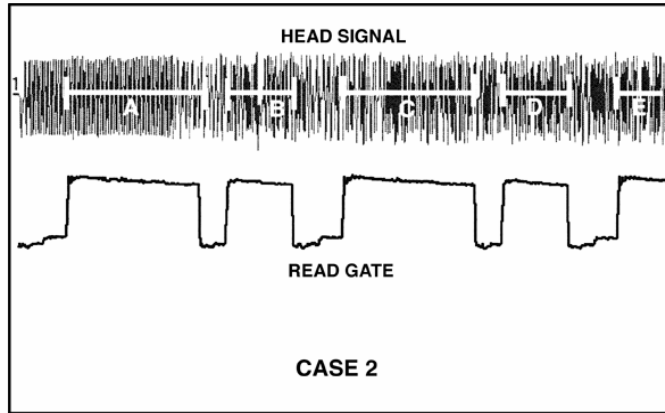

If Analyze Region is enabled and Read Gate is not available, only the area of the Head Signal within the region is analyzed, as shown in Case 3.

Case 3: Only the area within the Region is analyzed

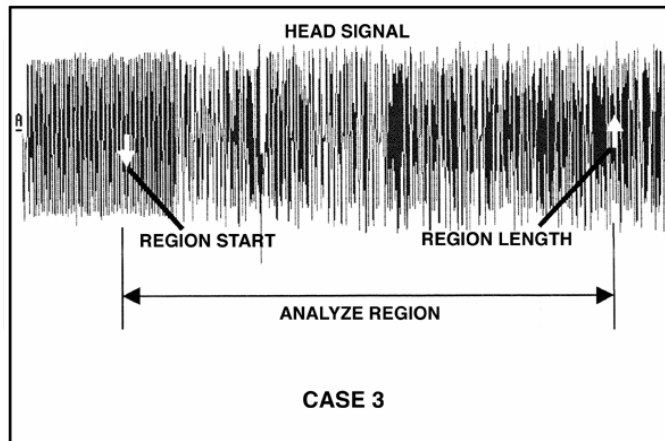

If neither the markers nor Read Gate are enabled, the entire Head Signal is analyzed (Case 4).

Case 4: The entire head signal is analyzed

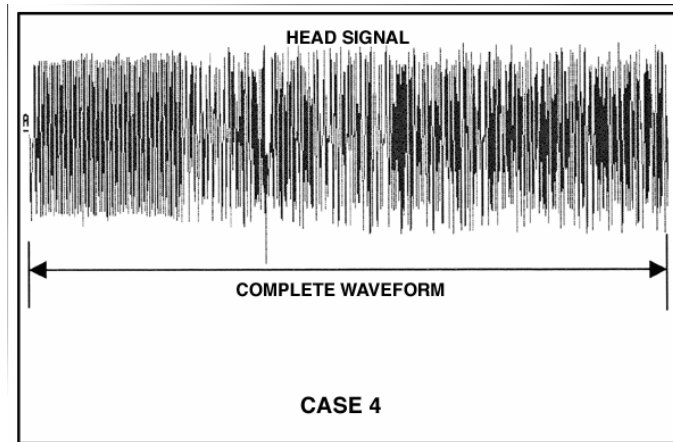

DDA Markers

If Read Clock is acquired by the DDA, the "sample time" markers can be drawn. Because the phase relation of RCLK to the head signal is not known, it is adjustable. It is worth noting here that the ML markers are at positions determined by the instrument's channel emulation; the sample time markers are at positions determined by the channel's sample clock signal with ML markers ("+" signs) and level markers (horizontal lines).

Setting Up to Use Drive Channel Analysis

There are several basic considerations when you are preparing to use Drive Channel Analysis. Which signals are to be provided to the DDA? What waveform section or sections will be analyzed? What will be used as the reference waveform? What trigger and time/div settings should be used?

Which Signals to Provide

The following is an overview of the signals that can be used by the DDA.

- Head Signal: The drive head signal is the only signal the DDA requires. The drive head signal can either be the signal after the pre-amplifier, or the one after the drive filter if available.
- Read Gate: Read Gate is "optional" for all error find methods; however, it is strongly recommended that you use Read Gate.

Choosing the Waveform Section to Be Analyzed

Before using Drive Channel Analysis, you should determine which part of the head signal will be analyzed.

The options you have are to analyze:

- Part of a single Read Gate cycle
- A single Read Gate cycle
- Multiple Read Gate cycles.

There are additional considerations for each of these choices.

If you choose to analyze a part of a single Read Gate cycle, it is important that it include the VCO Synch signal. Because it will be difficult to set up a reference signal if it is less than a single Read Gate cycle, it is recommended that this not be done with either the Analog Compare or Channel Emulation methods.

If you want to analyze a single Read Gate cycle, the easiest approach is to use the Read Gate signal and, if necessary, the Analyze Region cursors, to determine which section is analyzed. If you are using Channel Emulation or Analog Compare, you must make sure that the reference signal is the same length (see the following *Selecting the Reference Waveform*).

If you wish to analyze multiple Read Gate cycles, the setup is the same as for a single Read Gate cycle. The Read Gate signal and, if necessary, the Analyze Region cursors are used to determine which sections are analyzed. If you are using Channel Emulation or Analog Compare, you need to ensure that the reference signal is of similar makeup.

Except for Analog Compare, there are limits as to how much data the channel analysis methods can analyze at the same time:

- Channel Emulation **without** a reference saves ML sample results for up to 20,000 bits, which are used to draw the ML sample (+) markers.
- Channel Emulation **with** a reference saves up to 20,000 bits as its reference, while also saving ML sample results; there can be up to 250 separate Read Gate true sections in the data analyzed by Channel Emulation with reference.
- Analog Compare can handle one block of data of any length up to the maximum that can be acquired and stored by the DDA. It is the most computationally intensive error find method, so its use on maximum length waveforms will not be typical. Another indirect constraint on waveform size arises if Read Gate is used. If the source of Read Gate is set to something other than NONE, Read Gate will break the data into multiple blocks. In that case, there is a requirement that the start of each block, relative to the first block in the reference and the acquisition, be the same within the DDA's realignment window of about 12 bit cells.

Selecting the Reference Waveform

The Analog Compare and Channel Emulation with reference signal channel analysis methods compare the captured head signal to a stored reference head signal. For these methods, the appropriate menus will only appear after a head signal has been selected.

The stored reference should be acquired in the same manner (same time/div, sample rate, trigger position, etc.) and with the same timing as the acquisitions to which it is to be compared. It is not possible to compare a reference having only one sector to every sector in an acquisition containing many; and a split sector cannot be compared with an unsplit or differently split sector.

Generally, it is best that the reference signal be from the same drive section as the one with which it is to be compared. This will ensure that any splits that occur are in the same location. Another reason for selecting the same drive section is to avoid scrambler problems. If a drive uses a scrambler, two sections with the same logic data may have different head signals. Since Channel Emulation with reference and Analog Compare both analyze the head signal, they may see

differences between the reference and acquired signals due to the presence of the scrambler and not because real problems exist. If a scrambler is not present, it is reasonable to use other drive sections from the same zone as a reference.

The head signal can be stored as a reference simply in order to have a stored trace automatically overlapped with later acquisitions. This can be done even if the selected channel analysis method does not require a reference, or if you do not intend to use the method. This might be done just to scroll through waveforms using Auto Scroll to see how well they match.

Changing the source of the Head Signal or Read Gate invalidates the stored reference. You must store another valid reference for the new setup.

Time/Div Settings

The DDA allows you to keep acquiring a head signal until it finds a problem, at which point it will stop the acquisition so that errors can be analyzed. In order for Drive Channel Analysis to operate properly the DDA trigger must be set up so that the correct waveform section or sections are reliably acquired. The trigger setting must be selected to obtain the desired data on the display, in approximately the same position, in each acquisition.

In addition, the time/div must be set properly. Two factors should be taken into account when setting this. First, the time/div should be set to a sufficient duration so that the head signal sections that will be analyzed are captured. Second, in order for the DDA to correctly analyze a head signal it should have at least five ADC samples per bit cell.

For drives without ID, Read Gate only goes true to read the data of interest. If you can manually initiate a read operation of the desired data, this is easy: trigger on the leading edge of Read Gate, and every time the data is read, the DDA will trigger. Wait for the channel analysis to be done (the instrument rearms if no problems are found) before performing another read.

A precaution should be taken if more than a single Read Gate block of data is to be analyzed. For this situation, if reads are being performed repeatedly it is important to ensure that the trigger mode selected is not one that triggers solely on the occurrence of any Read Gate. Otherwise, the Read Gate block triggered on might sometimes be the second or later Read Gate true section.

If the drive provides Sector Pulses at the beginning of each sector it is recommended that the DDA's Sector Pulse trigger be used to avoid this problem.

Otherwise, a SMART Trigger® can easily solve this problem, by triggering on the first (or nth) Read Gate edge after Index.

If Read Gate is not available or its use is not desired, but looking at the head signal is, try triggering on Index and using a trigger delay to move out to the region of interest. Use the Analyze Region markers to delimit the area to analyze: for channel emulation methods the start marker should always be near the beginning of the VCO Synch field. However, even 0.1% speed variance becomes 0.8 s of jitter after 8 ms of delay. That is probably several hundred bit cells --- far more than Analog Compare can compensate for --- which may cause the channel emulation methods to miss the VCO Synch field entirely. Therefore this technique will not be able to look at sectors more than 1 or 2 ms delayed from Index.

If Read Gate is unavailable and you want to look at something other than sectors of data on the head signal, some repetitive signal such as Servo/Data can be used as Read Gate. Analog

Compare will have to be used then. The SMART Trigger can be set up as outlined above, except



that the bottom **Qualify by:** field should be set to time greater than , and the amount of time from index to just before the data of interest should be entered. This can be used to look at a particular servo burst, for example.

Automatically Shown Traces

When the source of the head signal is changed from **None** to an input channel or memory, a trace showing a zoom of the head signal is automatically created and displayed. If the **Filter head signal** checkbox is checked, the data in the trace is filtered. All channel markers selected will appear on this trace. All channel analysis methods analyze the (possibly filtered) data in the trace waveform (the entire waveform, not just the part displayed). **Byte** offset and **Worst Error #** change the horizontal position of this trace.

When **Store Reference** is selected, a trace showing a zoom of the stored reference is automatically established where possible. This means that whenever **Byte** offset or **Worst Error #** is changed, the reference will be realigned with the Head Signal at the new position. The reference signal will also be filtered if the **Filter head signal** checkbox is checked.

Setting Bit Cell Time

The value in the bit cell time menu is used as a starting guess for analyzing VCO Synch. It is also used by Byte offset and Analog Compare to determine how much time a byte occupies, and to set the -3 dB frequency of the DDA's equalizing filter (if enabled). It should be set correctly for the zone being read --- it does not need to be set on each read within the same zone.

Changing the bit cell time changes the filter's -3 dB frequency. The filter's settings should therefore be updated, or "trained" after the bit cell time has been changed. If the filter is on, the bit cell time must be fairly close for **Find Bit Cell Time** to work.

Retraining the Filter

Training the filter adjusts the boost and the -3dB frequency to optimize the mean of the worst 100 SAM values. The training starts by setting the -3dB frequency to 0.5/bit cell time. It then alternates optimizing the boost with optimizing -3 dB frequency. The 3 dB, boost and group delay values can also be independently set without having the DDA automatically train.

Choosing an Analysis Method

Which method or methods should be used? Deciding this depends on the type of problem and the information available.

By definition, a data error occurs in a drive when a bit is interpreted as a "1" when it should be a "0" or vice-versa. In order to gain insight into the cause of the error, it is generally desirable to examine the head signal at the location or locations where data errors occur. The DDA provides tools to help identify the likely location of a data error. In addition, with the instrument's channel emulation capability you are able to gain further insight into the cause of an error or errors once location is determined.

Before choosing a method, there are some basic questions that need to be answered:

- Is the byte position of the error known?
- Is a reference signal easily available?
- Is the error repetitive or intermittent?

Recommendations on the appropriateness of each analysis method are provided below.

Analog Compare

Analog Compare is the most general of the channel analysis methods, since it can be applied to all parts of the head signal, including VCO Synch, servo burst and data field. It is recommended for identifying the location of errors for peak detect signals. It can also be used for PRML signals, although Channel Emulation with a reference signal is the recommended method if a reference signal is available. See Using Analog Compare for a full description of this method.

Channel Emulation without Reference

Since it does not require a reference, Channel Emulation without a reference signal is the easiest of the channel analysis methods to use for PRML signals. This method performs channel emulation to determine the locations in the head signal that gave the Viterbi detector the most trouble in its decision as to the maximum likelihood sequence of samples. This means the state at a particular time, in the final surviving sequence, survived by the smallest margin. (The "state" corresponds to deciding on a "1" or "0" bit at each position.) The margin between keeping and rejecting what turned out to be the final choice for the state at that time is called the Sequenced Amplitude Margin (SAM). Unlike the compare methods, Channel Emulation without reference is based only on analyzing the quality of the head signal. It is generally assumed that the quality of the head signal is strongly correlated to the bit error or errors in nonreturn to zero (NRZ) data. Head signal sections that produce incorrect NRZ data are much more likely to be marginal when analyzed by the Viterbi detector. The most marginal sections are the first flagged by Channel Emulation as having the worst SAM. See Channel Emulation Without Reference for a full description of this method.

Sections with no signal transitions are one exception to this rule. These may not be identified as problematic by the Viterbi detector. However, if the Limit Run Length feature is enabled, sections with no transitions will be identified as errors if they exceed the run length limit.

Because it is the easiest of all methods, Channel Emulation without reference is generally the best to use first.

Channel Emulation with Reference

Channel Emulation with a reference is very useful if the error being looked for occurs at least fairly frequently and a reference head signal is available. If the error is not "hard," that is, it does not occur all the time, any acquisition may be stored as the reference; Channel Emulation with reference will catch acquisitions for which the DDA's channel emulation detects a different bit sequence. If the error is hard, a separate reference must be available. To have no errors detected, the reference must have the same bit pattern as the acquisitions with which it will be compared. This means each sector of the reference must be either unsplit or split in the exact same place as the matching sectors in the acquisitions with which it will be compared.

Channel Emulation without reference must assume that the final surviving sequence of bits is correct and only points out poor quality in the head signal. But Channel Emulation with reference

has a reference "correct" path and will catch differences even if both the reference and the comparison acquisition are high quality PRML signals. For Channel Emulation with a reference, the SAM values can be negative, indicating that a different decision was made (less than 0 margin to the "correct" state). The threshold below which an "error" is flagged is adjustable down to -1, to permit you to flag places where the DDA's channel emulation determines a different bit value for the head signal as compared to the reference head signal. See Channel Emulation With Reference for a full description of this method.

Channel Emulation without Reference

Channel Emulation without Reference finds a single trace and predicts the bits where the Sequenced Amplitude Margin (SAM) --- the distance or margin the Viterbi detector has for making a decision --- is poorest. It uses a full disk drive channel emulation to indicate how the signal ought to appear when a good reference signal is not available. It measures the SAM of all the samples (PRML clock locations).

The software emulates a PRML channel and ranks errors by SAM value. A distance or SAM value of "0" indicates no margin for a decision and the detector's lack of certainty as to whether the digital bit should be "1" or "0." The positions of the 100 worst margins are identified and can be displayed along with the SAM value of each.

Using complete disk drive channel emulation, Channel Emulation without reference predicts where the head signal quality is the poorest in respect of a PRML channel's ability to confidently select a "1" or "0" value.

Channel Emulation without reference starts by finding the beginning of the sector. The algorithm looks at the head signal beginning at the Read Gate true transition (or analyze region start if Read Gate is not available) and tries to synchronize to the VCO Synch pattern in order to establish sampling phase and expected sample levels. To accomplish this, it is required that **VCO Synch Pattern** be set correctly, and that the "Bit Cell Time" be approximately correct. The data is then passed through the emulated channel where it is appropriately sampled. The sampled output enters the Viterbi detector, which chooses the "sequence" of bits (history) that is the most likely when the new bit due to this sample is appended. The difference between the mean squared distance (msd) of the selected sequence and the other possible sequence leading to the selected state (SAM) is then calculated. For each sample in the Viterbi detector, Channel Emulation without reference determines a SAM indicating the confidence it has in making a decision between the two most likely sequences.

If **Run Length Limit** has a non-zero value, run length limit will also be detected and violations reported.

If Read Gate is present, it does not necessarily go false immediately after the last byte of valid information, usually error-correcting code (ECC). The delay is due to the propagation time through the channel chip and any delays from the controller. Therefore, you can specify the amount of 'garbage' data to ignore after the end of the written data and before Read Gate goes false. Errors detected in this area will be ignored.

When Channel Emulation without reference runs, the ML markers ("+" signs) are automatically displayed. These show the Maximum Likelihood sample sequence that the channel emulation chose, based on the signal and the possible sequences. They are drawn at the expected level at

the time the channel sampled the head signal. If the "+" signs are all very close to the waveform, the signal is good. If the "+" signs are not close to the waveform, the signal may not be good. The ML markers do not appear if more than 500 are needed on the display. If they are on but not visible, zoom in on the head signal.

Additionally, you can turn on Level Markers, horizontal lines that show the expected levels at the center of the screen.

The ML markers do not appear if more than 50 are needed on the display; if they are on but not visible, they can be zoomed.

The Channel Emulation without reference method can be used either on newly acquired channel data or data previously saved in a memory. The following information is required:

- **Head Signal:** The VCO Synchronization field is needed at the beginning of the area to be analyzed. If the VCO Synch field is not found, Channel Emulation without reference will not be able to analyze the signal.
- **Signal Type:** Specifies the type of PRML channel.
- **VCO Synch Pattern:** In a normally operating disk drive, every time Read Gate goes true (at the beginning of every segment to be read) there must be a repetitive signal called the VCO Synch. It is required for adjustment of the phase of the PLL (phase locked loop), which generates the sampling clock, as well as adjustment of the AGC (automatic gain control). Most commonly, the VCO Synch is 2T (a transition every other bit cell).
- **Bit Cell Time** is used as a starting estimate of the VCO Synch signal. If the value is not known and the VCO Synch field is at the beginning of the area to be analyzed, touching the **Measure Bit Cell Time** button will determine it automatically.
- **Ignore Last <n> Samples:** Specifies the amount of 'garbage' data to ignore after the end of the written data and before Read Gate goes false.
- **SAM Threshold:** This is the user-specified threshold used by Channel Emulation without Reference to decide when to record an error. SAM is the difference in mean squared distance between the samples observed from the sequence of samples decided upon as the likely sequence and the one discarded at that decision point. See Note 1 below.
- **Run Length Limit (k):** If RLL encoding is set to zero, no check is made and Channel Emulation without Reference only reports errors due to difficulty deciding on a sequence of samples (small SAM). If set to a non-zero value, it specifies the number of permitted non-transitions in a row. See Note 2 below.
- **Adjacent Transitions:** Corresponds to the "d" in RLL code specified as m/n(d,k). See Note 3 below.

Additionally, these parameters are useful (though not essential) for Channel Emulation without reference:

- **Read Gate:** If the Read Gate signal is connected to a DDA channel and specified, it will be used to determine the regions of the signal to be analyzed. Since the VCO Synch

field is required for Channel Emulation, and it is normally present in the head signal in every block just after Read Gate goes true, it is recommended that Read Gate be used. If Read Gate is not present, the entire waveform will be used unless the Analyze Region cursors are enabled.

- **Read Gate Polarity:** Typically, Read Gate is a positive true signal. However, there are drives that use a negative true signal for Read Gate. If Read Gate is enabled, this setting allows you to select whether "True" is high or low.
- **Specify Region:** As previously described, markers can be used to define a subset of the head signal for analysis.
- **Filter Head Signal:** If enabled, an equalization filter is applied to the head signal before processing and display. This feature should be used if the DDA does not have access to the drive's equalized head signal.

Notes on Using Channel Emulation without Reference

1. Sequenced Amplitude Margin (SAM) is used by the Viterbi detector to decide whether a bit should be "1" or "0". As the Viterbi detector receives each sample, the detector must choose between two possible sequences, which lead to the state it selects. The sequence with the best fit determines which state is selected. SAM indicates how much better the surviving sequence is than the one that is discarded from further consideration. "0" means the Viterbi Detector has no preference at all between the sequence it chose and one it threw away at a particular sample. The most positive value is the square of the "minimum error distance" for the selected Signal Type, and implies excellent certainty about which sequence to keep. SAM values are associated with the sample leaving the Viterbi detector's trellis, that is, the sample about which the final decision is being made. The SAM includes the effect of all previous samples in the block and of the following samples that are already in the trellis. Near-zero SAM values are due to distortions in the shape of the head signal. Problems causing distortions, which Channel Emulation without Reference can find, include media defects and dropouts, asperities, noise bursts, or a bad head. (Noise bursts are sometimes obscured by the equalization filter, and result in a distorted shape of a pulse. To see if this is the cause of a distorted shape, look at the unfiltered waveform also.) Without a reference Channel Emulation without Reference does not know if the decisions it makes actually correspond to what was written, it only knows how good the head signal looks when the disk is read. As an example, suppose a disk occasionally simply fails to write several transitions, resulting in a flat area in the head signal. All the pulses are the correct shape, it's just that some aren't there at all. This can still be caught if it causes a Run Length Limit violation and that check was enabled, but it might not be a problem for the Viterbi detector.
2. When checking for run length limit (RLL) violations, "k" of the RLL code "m/n(d,k)" must be specified: "k" is the maximum number of non-transitions between transitions. When **Run Length Limit** is set to a non-zero value, Channel Emulation without Reference also counts the number of non-transitions in a row and checks against the user specified limit. Examples: we recommend that k be set to 8 to handle 8/9(0,4,4) codes; set k to 7 for 2/3(1,7) modulation code.
3. **d** is the minimum number of non-transitions between transitions. When d=0, adjacent

transitions are allowed. When $d=1$, adjacent transitions are not permitted. For E2PR4 it can also be set to $d=2$. A non-zero d eliminates several possible sequence choices (states and transitions in the Viterbi detector). If set to **1** when it should be **0**, Channel Emulation without Reference will almost certainly detect a large number of "errors." If set to **0** when it should be **1**, it is possible that Channel Emulation without Reference will pass a few bits that should have been flagged as errors.

Channel Emulation with Reference

Whereas Channel Emulation without Reference acquires a single trace and makes a prediction of problems based on signal quality, when the method is used with a reference signal, it calculates the Viterbi output of the reference, as well as that of the acquired trace, and compares the two to find mismatches.

Channel Emulation with Reference starts by finding the beginning of the sector. The algorithm looks at the head signal beginning at the Read Gate true transition (or analyze region start if Read Gate is not available) and tries to synchronize to the VCO Synch pattern in order to establish sampling phase and expected sample levels. To accomplish this, Channel Emulation with reference requires that **VCO Synch Pattern** be set correctly, and that the **Bit Cell Time** be approximately correct. Because the position of Read Gate relative to the head signal can jitter from read to read, the method aligns the two bit streams it is comparing based on the end of the repetitive VCO Synch pattern. If there is an error within the VCO Synch pattern, this will be found, but the method may also find many other mismatches if incorrectly aligned.

The data is then passed through the emulated channel where it is appropriately sampled. The sampled output enters the Viterbi detector, which chooses the "sequence" of bits (history) that is the most likely when the new bit due to this sample is appended.

SAM is the margin between keeping and rejecting the correct state in the sequence, at any point. Channel Emulation **without** reference essentially assumes that the output of the Viterbi detector is "correct," and gives the margin between that and a different decision at each bit position. It must do this because it does not have a reference. Therefore SAM results are always greater than zero from Channel Emulation without reference --- they are the margin from the final decision to some other decision.

Channel Emulation **with** reference performs channel emulation on the reference signal when it is stored and saves the resulting bit sequence. When "Emulation" is turned on it performs channel emulation on each subsequent acquisition and looks at the margin for the states in the final surviving state of the reference bit sequence. As long as the bit sequence for the current acquisition and the reference acquisition match, the margin is > 0 . When a different decision is actually made the margin reported is less than zero: there was less than zero margin to making a different decision; a different decision was actually made. Even if both signals are of excellent quality, but different, Channel Emulation with a Reference signal will catch it.

This divergence of paths through the detector may be referred to as an "error event." After a very few bits, typically, the paths converge again. The SAM reported for the bit where the paths converge will also be negative. This is because the reference and acquisition disagree on the previous bit, and the state of the detector reflects the current bit and at least one previous bit (for PR4).

Note: Unless a drive is in a diagnostic mode (direct write), data is scrambled and encoded when written. In the drive, after the Viterbi detector finds the bit pattern that was written, the bit pattern is decoded and de-scrambled to recover the user data. The DDA does not do the decoding or de-scrambling; it does not need to recover the user data in order to find problems in the quality of the head signal or differences from a reference. This means, however, that each bit in error in the head signal may turn into multiple bits in error in the user data (for example, if it resulted in a different valid 9 bit pattern in 8/9 encoding).

In addition, a normally operating drive tries to correct short bursts of errors in the user data using an Error Correcting Code syndrome, so an error in the head signal may result in no bits after Error Correction if it was within the capability of the ECC to correct it. Usually the bit error rate is measured without Error Correction to check drive operation. The ECC is only capable of correcting a limited number of errors in a sector, so keeping the number of raw errors low is a requirement.

The SAM values shown by Channel Emulation with a reference signal directly reflect where the DDA's channel emulation believes an error (without Error Correction) would occur. The SAM threshold determines the value of SAM below which a bit position is recorded on the Channel Emulation's "error" list. For Channel Emulation with a reference, you can set the SAM down to -1. This allows the use of either inclusion or exclusion of positions with close to zero SAM, which might or might not actually be an error. If the threshold is set near -1, only places where the decision to reject the reference bit sequence was made with considerable certainty will appear in the DDA error list. If the threshold is greater than zero, all the places where Channel Emulation calculates the bit sequences will differ, and some places close to making an error (small positive margin) will be included in the error list.

If Read Gate is present, it does not necessarily go false immediately after the last byte of valid information usually error-correcting code (ECC). The delay is due to the propagation time through the channel chip and any delays from the controller. Therefore, you can specify the amount of "garbage" data to ignore after the end of the written data and before Read Gate goes false. Errors detected in this area will be ignored.

When Channel Emulation with a reference signal runs, the ML markers ("+" signs) are automatically displayed. These show the Maximum Likelihood sample sequence that the DDA's channel emulation chose, based on the head signal and the possible sequences. They are drawn at the expected level at the time the channel sampled the head signal. Since Channel with reference requires a stored reference signal, the reference trace will be overlapped with the head signal.

The ML markers do not appear if more than 500 are needed on the display; if they are on but not visible, zoom in on the head signal.

Channel Emulation with reference uses the same channel emulation as Channel Emulation without reference signal.

Channel Emulation with reference requires the following setup, including a stored reference signal:

- **Head Signal:** The VCO Synchronization field is needed at the beginning of the area to be analyzed. If the VCO Synch field is not found, Channel Emulation with reference will not be able to analyze the signal.
- **Reference:** A reference waveform must be acquired and processed by selecting "STORE REFERENCE" --- subsequent acquisitions will be processed and then compared to this.
- **Signal Type:** Specifies the type of PRML channel.

- **Adjacent Transitions (d):** Corresponds to the "d" in RLL code specified as m/n(d,k) --- "d" is the minimum number of non-transitions between transitions. If d=0 then adjacent transitions are allowed. If d=1, then adjacent transitions are not permitted. For E2PR4 this field can also be set to d=2.
- **VCO Synch Pattern:** In a normally operating disk drive, every time Read Gate goes true (at the beginning of every segment to be read) there must be a repetitive signal called the VCO Synch. It is a requirement to adjust the phase of the PLL (phase locked loop), which generates the sampling clock, and to adjust the AGC (automatic gain control). Most commonly the VCO Synch is 2T.
- **Bit Cell Time:** is used as a starting estimate of the VCO Synch signal. If the value is not known and the VCO Synch field is at the beginning of the area to be analyzed, selecting **Measure Bit Cell Time** will determine it automatically.
- **Ignore last <n> samples:** Specifies the amount of "garbage" data to ignore after the end of the written data and before Read Gate goes false.

Additionally, the parameters below are useful (but not essential) for Channel Emulation with reference:

- **Read Gate:** If the Read Gate signal is connected to a DDA channel and specified, it will be used to determine the regions of the signal to be analyzed. Since the **VCO Synch** field is required for Channel Emulation with Reference and is normally present in the head signal in every block just after Read Gate goes true, it is recommended that Read Gate be used. If Read Gate is not present, the entire waveform will be used unless the Analyze Region cursors are enabled.
- **Read Gate Polarity:** Typically, Read Gate is a positive true signal. However, there are drives that use a negative true signal for Read Gate. If Read Gate is enabled, this setting allows you to select whether "True" is high or low.
- **Read Clock:** If present, the Read Clock signal is used only to determine where the "sample time" markers (vertical lines) are drawn.
- **Specify Region:** As previously described, markers can be used to define a subset of the head signal for analysis.
- **Filter Head Signal:** If enabled, an equalization filter is applied to the head signal before processing and display. This feature should be used if the DDA does not have access to the drive's equalized head signal.

After the setup is complete, a reference waveform should be acquired and saved by selecting **Store Reference**.

Notes on Using Channel Emulation with Reference

1. Time misalignment between the reference and the current acquisition is made up for based on end of VCO Synch in the first Read Gate true section. If the reference contains multiple Read Gate true sections, we assume that their relative timing is approximately the same as in the current acquisition.
2. It is not possible to compare a reference of one sector to each sector in an acquisition

containing many. It is not possible to compare a split sector with an unsplit or differently split sector.

Using Analog Compare

This method compares a reference signal to subsequent acquisitions and looks for large changes in the waveform. It is a general purpose test method that can be applied to finding errors in practically any signal, including VCO Synchronization fields, data and servo-information.

The user stores a "good" reference analog waveform. On subsequent acquisitions the filter, if selected, equalizes the newly acquired waveform. Analog Compare then attempts to measure the bit cell time and to find the end of VCO Synch, on both the stored reference and the acquired waveforms. If that succeeds the comparison starts, aligned by the marks at the end of VCO Synch. If the waveforms being compared do not contain VCO Synch, or if Read Gate is not used, the message "Could not analyze VCO Synch at start of signal" is displayed. This is just a warning, in case it is believed that VCO Synch ought to have been found. Analog Compare will proceed anyway.

Analog Compare computes the mean squared distance (msd) between the stored reference waveform and the head signal, over a 3-byte-wide window. The two waveforms are aligned to the nearest sample at the start. As the window is moved across the waveforms, alignment to the nearest sample is maintained as long as the timing in the reference is within 1% of the timing of the head signal. When the normalized msd exceeds the user-set Analog Threshold, an error will be recorded on the error list; the position of the maximum difference in the reference and the head signal is recorded. If the difference remains above threshold for more than the length of an encoded byte, a new error is recorded at each byte. Errors are ordered in the error list from largest to smallest difference.

Analog Compare requires some setup, and a stored reference signal to compare to before it can be used. The following must be provided.

Head Signal: As with the other methods, the head signal is essential for Analog Compare. Unlike the other methods, however, Analog Compare will work on any part of the head signal.

Reference: The stored reference should be acquired in the same manner (same time/div, sample rate, trigger position, etc) as the acquisitions that will be compared to it. See Note 3 below.

Analog Threshold: This is the user-specified threshold used by Analog Compare to decide when to record an error. A typical value for the Analog Threshold might be about 0.025. See Note 1 below.

Additionally, these parameters are useful (but not essential) for Analog Compare:

Read Gate: If the Read Gate signal is available, it will be used as described in Note 2, below.

Read Gate Polarity: Typically, Read Gate is a positive true signal. However, there are drives that use a negative true signal for Read Gate. If Read Gate is enabled, this setting allows you to select whether "True" is high or low.

Read Clock: If present, the Read Clock signal is used to determine where the "sample time" markers are drawn.

Use Analyze Region: As previously described, markers can be used to define a subset of the head

signal for analysis.

Bit Cell Time: If specified, will be used to determine window size for comparison, otherwise a default value is used.

Code Rate: If provided, this is used to determine the size of an encoded byte, which is needed in determining the window size for Analog Compare.

Filter Head Signal: If enabled, an equalization filter is applied to the head signal before processing and display. This feature should be used if the DDA does not have access to the drive's equalized head signal.

After the setup is complete, a reference waveform should be acquired and saved by touching **Store Reference**.

Notes on Using Head/Analog Compare

1. Setting Analog Threshold: The "Analog Threshold" sets how large the difference (mean squared distance) between the reference and the acquisition must be to be recorded as an "error". A threshold of zero means that even the slightest difference will be enough. The threshold is normalized to full scale, which means that a setting of 1.000 specifies that the signals must mismatch by full scale over the entire three byte wide analysis window to be recorded as an error. DC mismatch is compensated and does not contribute to "mismatch".

If the waveform amplitude can be -full scale to +full scale, the formula relating threshold to number of divisions mismatch (without vertical zoom) --- average over the analysis window --- is: $\sqrt{\text{thresh}}$. For example, a threshold of 0.015 corresponds to 0.49 of a division average mismatch within the window.

2. Analog Compare works best if it can analyze VCO Synch at the beginning of its analysis region for both the reference and the head signal. If Read Gate is available it should be able to do that. If Read Gate is not available, the "Analyze Region" cursors can be turned on and the "start" marker positioned near the beginning of a VCO Synch field. This also will let Analog Compare analyze the VCO Synch field and align reliably. If Read Gate is not available, and VCO Synch is not available, then Analog Compare attempts to align the signals up to about 12 bit cells difference. Note that if the start of the analysis region is far from the $t=0$ (trigger) position then small speed variations can cause the waveforms to be too misaligned for Analog Compare to be correct. For example, if the start of the analysis region is 15,000 bit cell times after the trigger, a 0.1% speed variation gives 15 bit cell times of jitter at the start of the analysis region. No matter how it achieves alignment, Analog Compare attempts to maintain alignment for up to a 1% speed mismatch. Analog Compare compensates for misalignment in the reference and acquisition based on the first Read Gate edge (if a source of Read Gate has been specified), and if it can analyze VCO Synch, on the end of the VCO Synch in that first section. If Read Gate is being used and the reference contains multiple Read Gate true sections, then the timing between them in the reference and the acquisitions must match within the alignment tolerance of Analog Distance, about 12 bit cells.
3. The reference waveform must be the same as the waveforms it is compared to. That means it must be the same length, acquired at the same horizontal and vertical scales. The same regions of the new and reference waveform will be compared. That means it is not

possible to store a reference of a single sector and compare it to subsequent acquisitions containing multiple sectors. It is also not possible to compare a split sector to an unsplit or differently split sector. The reference and the acquisition must basically match.

Local Feature Concepts

Overview

The term "local feature computation" indicates that a parameter computed on a waveform is determined only by information in the immediate vicinity of a specified feature of that waveform. The DDA defines a local feature as a waveform peak followed by a trough, like this:

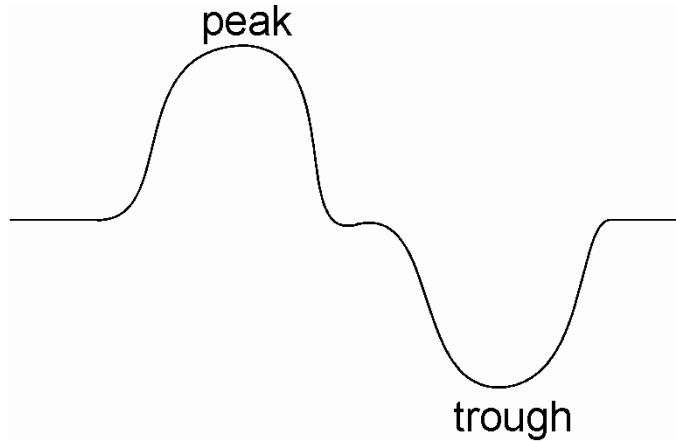

However, it is not the opposite --- a trough followed by a peak. The diagram below shows a single local feature: the first peak and the trough that follows it.

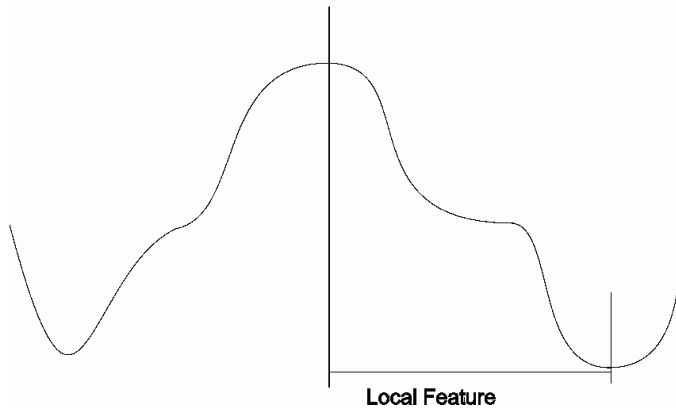

Peak-Trough Identification

The key to identifying peak-trough pairs is the ability to discriminate between real pairs and false ones. For example, noise in a signal can be mistaken for a local feature, as here:

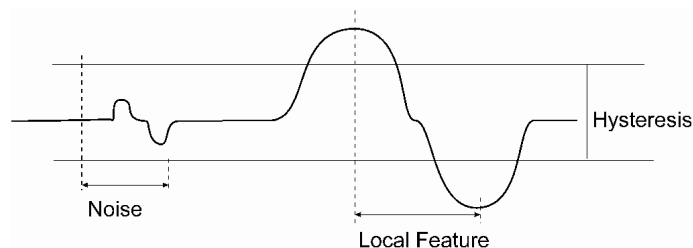

Similarly, 'bumps' in a waveform may also be mistaken for peak-trough pairs.

In order to avoid such misidentification, a hysteresis argument is provided for many local feature parameters. This essentially enables you to set a voltage band, which a peak-trough pair must exceed in order not to be considered noise or a "bump."

The hysteresis setting is also essential to the way peaks and troughs are identified by the DDA.

The search for local features extends from the left to the right parameter cursor. But first a peak must be found; and a waveform must rise to at least the value of the hysteresis setting in order to be positively identified as a peak.

This peak search starts with the first waveform sample, whose voltage value is used as an initial reference value for locating the peak. If a following waveform sample is found to be higher than the first by an amount greater than the hysteresis setting, a peak is said to exist. Any sample lower than the reference value, made prior to determination of a peak's existence, is used as a new reference point.

When a waveform rises by an amount that is more than the hysteresis, compared to the lowest prior waveform sample, the criterion for the existence of a peak is met. Then the search for its exact location and voltage value is initiated. Successive samples are compared to find the highest sample. Next, two points are found, one on either side of this highest sample and down from it by at least 25 % of the distance to the previous trough amplitude. A quadratic interpolation is then performed on these three samples to find the new peak location and amplitude. The same approach, using a sample lower than the highest sample by more than the hysteresis setting, is used to locate the trough.

Local Baselines

Many parameter measurements require that the baseline of a local feature be identified. In order to account for asymmetries due to MR heads, baselines are identified between the peak and trough, and between the trough and the following peak.

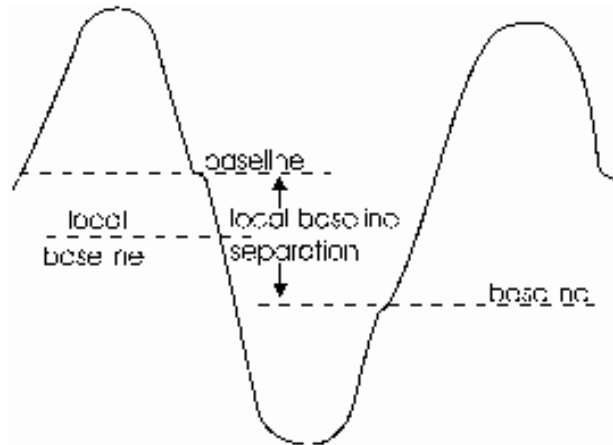

The baselines are found by locating a point at which the waveform 'rests' between the peak and trough and peak. These resting points are identified by statistically measuring the area of least change in voltage value between the peak and trough or trough and peak, with internal tolerance levels set to ensure against false baseline identification.

Another condition for identification is that the resting points must fall within a band, centered around the midpoint of the peak and trough extremes, whose height is $2/3$ of the peak-to-trough height.

If one of the baselines cannot be identified, the local baseline is set to the found value. If neither baseline can be identified, then the local baseline is set halfway between the extremes of the local feature's peak and trough.

If baselines can be identified on both falling and rising slopes, the local-feature baseline is an average of the two baselines and 1 bsep is the distance between them.

If the local feature is the last to be identified before arriving at the end of the region being analyzed, it will not be possible to identify the trough-to-peak baseline of the following local feature. But when the peak-to-trough baseline is identified, then these two baselines are assumed to be separated by the same distance as the baselines for the previous local feature. And if this baseline cannot be identified, then the local baseline becomes the midpoint of the local peak and trough.

The separation between the baselines (local baseline separation) can also be of interest in determining the validity of certain measurements.

The following table summarizes the determination of the local baseline and its separation when the local feature is and is not the last identified before the right parameter cursor:

Local baseline and local baseline separation if last local feature		
Baseline identified peak-to-trough (PTBase)	Local Baseline	Baseline Separation
yes	$(PTBase + [PTBase + \text{previous separation}])/2$	previous local feature's baseline separation
no	midpoint of local peak and trough	0

Local baseline and local baseline separation if not last local feature			
Baseline identified peak-to-trough (PTBase)	Baseline identified trough-to-peak (TPBase)	Local Baseline	Baseline Separation
yes	yes	average of PTBase + TPBase	$PTBase - TPBase$
yes	no	PTBase	0
no	yes	PTBase	0
no	no	midpoint of local peak and trough	0

Setting Hysteresis

Hysteresis must be set for all local parameters. The determining factors for a hysteresis value are:

1. The maximum peak-to-peak noise in the waveform
2. The minimum local feature amplitude

The value should be somewhere between the first and second factors to ensure that noise is not mistaken for a local feature, and that all local features are recognized.

Local Parameters

The local parameters group offers measurements of common disk drive waveform parameters.

Local Parameter	Definition
lbase	baseline of local feature
lbasep	separation between peak-to-trough and trough-to-peak baselines
lmax	maximum value of local feature

lmin	minimum value of local feature
lnum	number of local features displayed
lpp	local feature's peak-to-trough amplitude
ltbe	time between peak-to-trough or trough-to-peak
ltbp	local feature's time between peaks
ltbt	local feature's time between troughs
ltmn	time of local feature's minimum value
ltmx	time of local feature's maximum value
ltot	local feature's time over a % threshold
ltpt	time between local feature peak-to-trough
lttp	time between trough-to-following peak
ltut	local feature's time under a % threshold

Note: The DDA's variable hysteresis setting is essential to identifying peak-trough pairs.

Local Feature Parameters

lbase

Local Base

Definition The value of the baseline for a local feature.

Description The average value of the local baselines for all local features between the parameter cursors is displayed as lbase. For histograms, each individual baseline value for all local features between the parameter cursors is provided.

Parameter Settings Selecting this parameter from the **Measure** menus prompts you for a hysteresis setting, which allows you to set the hysteresis value to a specified number of vertical divisions.

Example

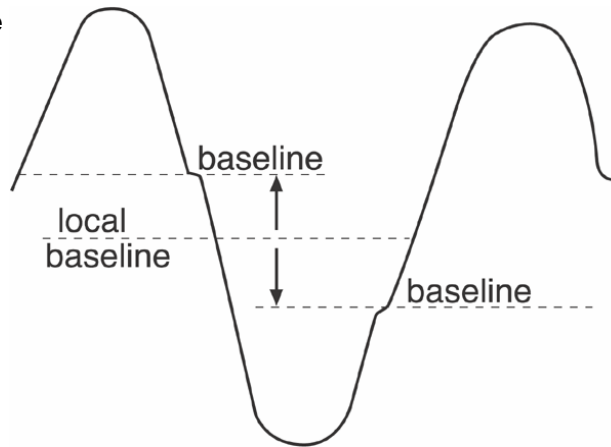

lbsep

Local Baseline Separation

Definition The value of the baseline separation for a local feature.

Description The average value of the separation of the two baselines used to calculate a local baseline is displayed for all local features between the parameter cursors. For histograms, each individual baseline separation value for all local features between the parameter cursors is provided.

Parameter Settings Selecting this parameter from the **Measure** menus prompts you for a hysteresis setting, which allows you to set the hysteresis value to a specified number of vertical divisions.

Example

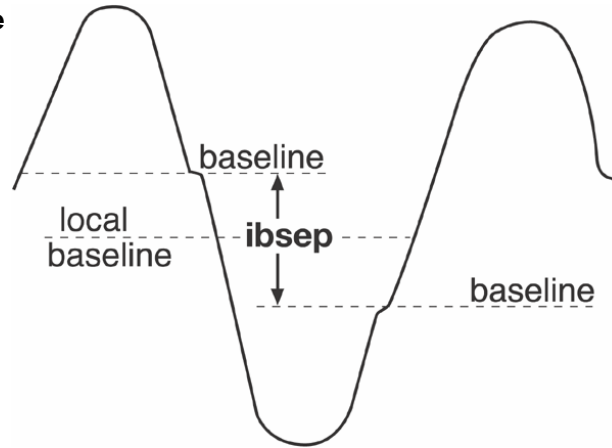

I_{max}

Local Maximum

Definition The maximum value of a local feature.

Description The maximum value of all local features between the parameter cursors is determined, and the average value is displayed as I_{max}. For histograms, the maximum value of each local feature between the parameter cursors is provided.

Parameter Settings Selecting this parameter from the **Measure** menus prompts you for a hysteresis setting, which allows you to set the hysteresis value to a specified number of vertical divisions.

Example

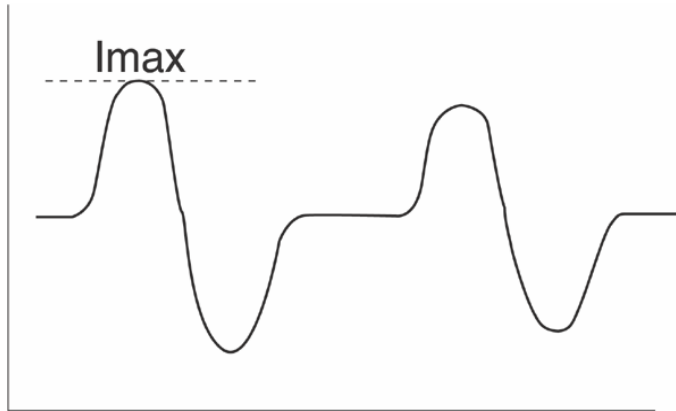

Imin

Local Minimum

Definition The minimum value of a local feature.

Description The minimum value of all the local features between the parameter cursors is determined, and the average value is displayed as Imin. For histograms, the minimum value of each local feature between the parameter cursors is provided.

Parameter Settings Selecting this parameter from the **Measure** menus prompts you for a hysteresis setting, which allows you to set the hysteresis value to a specified number of vertical divisions.

Example

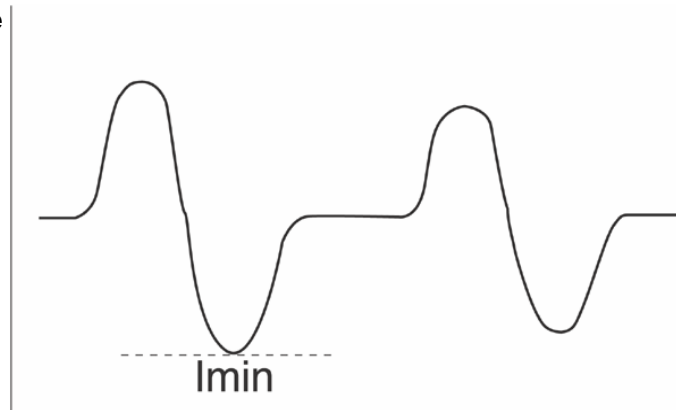

Inum

Local Number

Definition The number of local features in the input waveform.

Description The number of local features between the parameter cursors is determined and displayed as Inum. One value of Inum each sweep is provided for histograms.

Parameter Settings Selecting this parameter from the **Measure** menus prompts you for a hysteresis setting, which allows you to set the hysteresis value to a specified number of vertical divisions.

Example

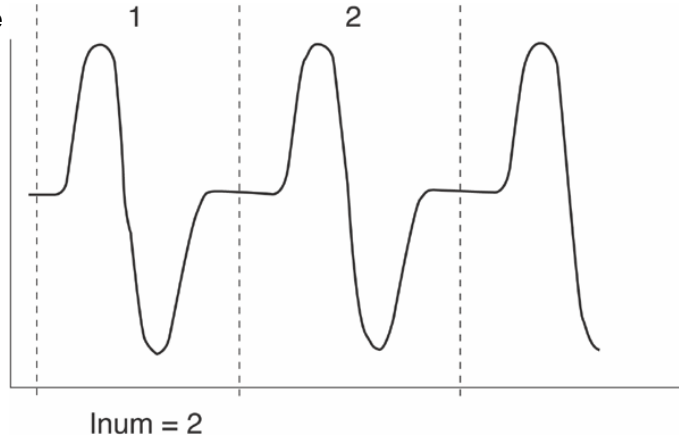

Ipp

Local Peak-to-Peak

Definition The vertical difference between the peak and trough for a local feature.

Description The peak-to-trough voltage difference is determined for all local features in a waveform, and the average is displayed as Ipp. Provided for histograms is the peak-to-peak value of each local feature between the parameter cursors.

Parameter Settings Selecting this parameter from the **Measure** menu prompts you for a hysteresis setting, which allows you to set the hysteresis value to a specified number of vertical divisions.

Example

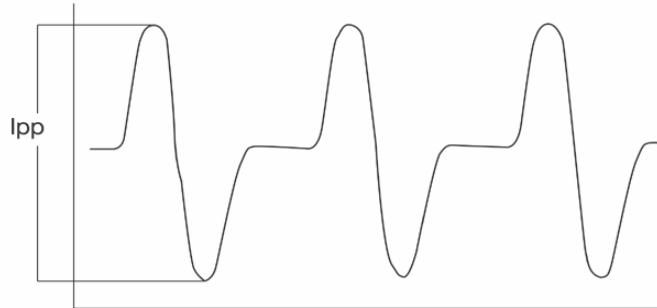

ltbe

Local Time Between Events

Definition The time between a local feature peak and trough or a local feature trough and the next local feature peak.

Description Events are defined as either peaks or troughs. The average time between successive events in a waveform is displayed as ltbe. Provided for histograms is the time between each successive event between the parameter cursors

Parameter Settings Selecting this parameter from the **Measure** menus prompts you for a hysteresis setting, which allows you to set the hysteresis value to a specified number of vertical divisions.

Example

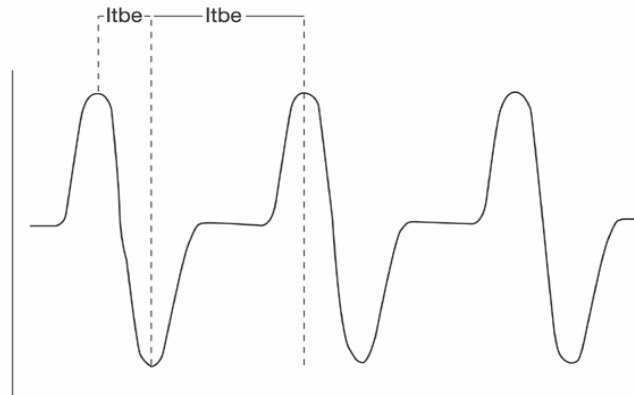

ltbp

Local Time Between Peaks

Definition The time between a local feature peak and the next local feature peak.

Description The average of the time between successive local feature peaks is determined, and its value displayed as ltbp. Provided for histograms are the times between successive peaks for all peaks between the parameter cursors.

Parameter Settings Selecting this parameter from the **Measure** menus prompts you for a hysteresis setting, which allows you to set the hysteresis value to a specified number of vertical divisions.

Example

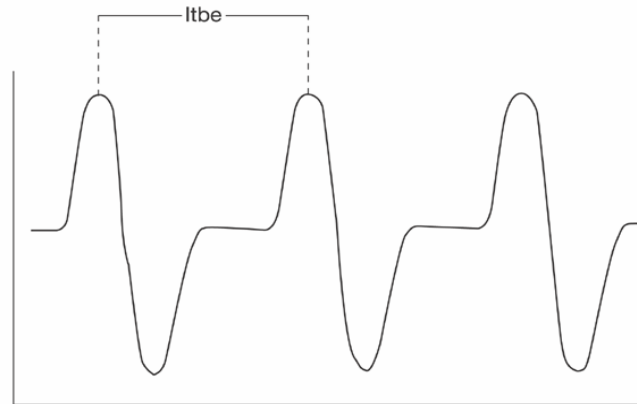

ltbt Local Time Between Troughs

Definition The time between a local trough and the next local trough.

Description The average of the time between successive troughs is determined, and its value displayed as ltbt. Provided for histograms are the times between successive troughs for all troughs between the parameter cursors.

Parameter Settings Selecting this parameter from the **Measure** menu prompts you for a hysteresis setting, which allows you to set the hysteresis value to a specified number of vertical divisions.

Example

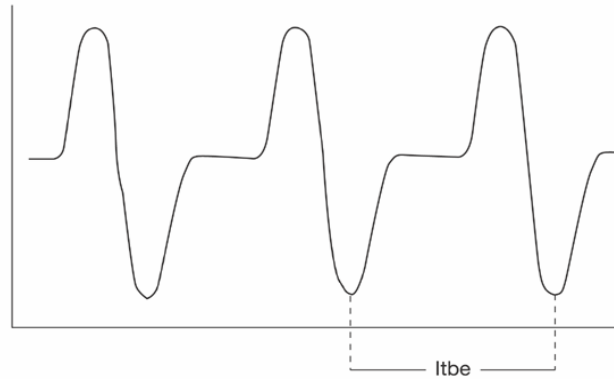

Itmn

Local Time at Minimum

Definition The time of the minimum value of a local feature.

Description The time of the minimum value of the first local feature in a waveform after the left parameter cursor is determined. The time is returned as Itmn. Provided for histograms are all times for local feature minimums between the parameter cursors.

Parameter Settings Selecting this parameter from the **Measure** menus prompts you for a hysteresis setting, which allows you to set the hysteresis value to a specified number of vertical divisions.

Example

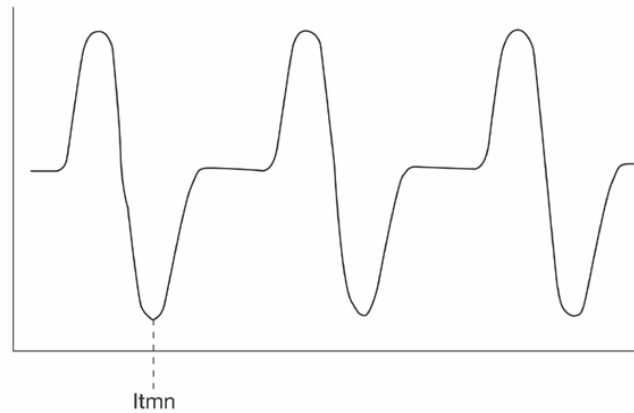

Itmx

Local Time at Maximum

Definition The time of the maximum value of a local feature.

Description The time of the maximum value of the first local feature in a waveform, after the left parameter cursor, is determined and returned as Itmx. Provided for histograms are all times for local feature maximums between the cursors.

Parameter Settings Selecting this parameter from the **Measure** menus prompts you for a hysteresis setting, which allows you to set the hysteresis value to a specified number of vertical divisions.

Example

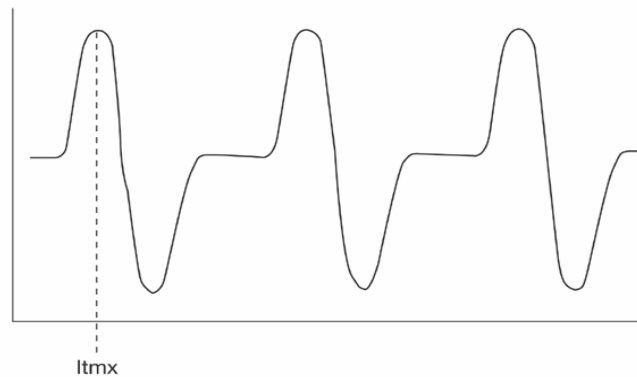

Itpt Local Time Peak-to-Trough

Definition The time between a local feature peak and trough.

Description The average of the time between all local feature peaks and troughs is displayed as Itpt. Provided for histograms are the times between peak-trough pairs for all local features between the parameter cursors.

Parameter Settings Selecting this parameter from the **Measure** menus prompts you for a hysteresis setting, which allows you to set the hysteresis value to a specified number of vertical divisions.

Example

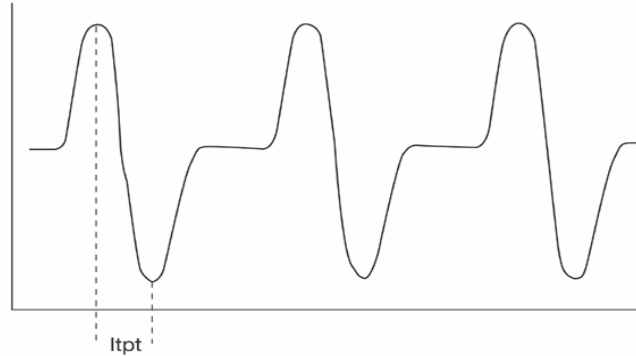

Itot

Local Time Over Threshold

Definition The time a local feature spends over a user specified percentage of its peak-to-trough amplitude.

Description The peak-to-trough height of a local feature is measured. The time the local feature spends over a user specified percent of the peak-to-trough height is then determined. The average for all local features in a waveform is displayed as Itot. Provided for histograms is the time spent over the threshold by each local feature between the parameter cursors.

Parameter Settings Selecting this parameter from the **Measure** menu displays hysteresis and level percent menus. The associated fields allow you to set values in those menus: a specified number of vertical divisions or a percentage of the peak-to-peak height of the local feature.

Example

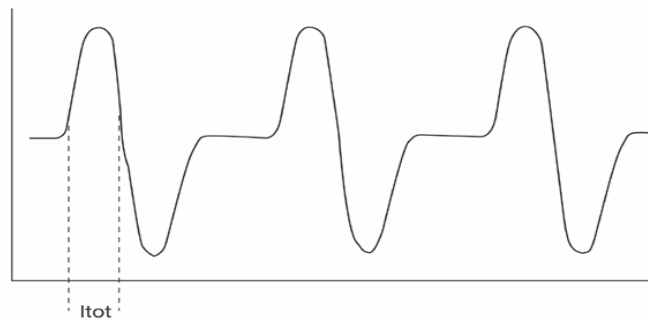

lttp

Local Time Trough-to-Peak

Definition The time between a local-feature trough and the next local-feature peak.

Description The average of the time between all local feature troughs and the following local feature peak is displayed as lttp. Provided for histograms are the times between trough and following peak for all local features between the parameter cursors.

Parameter Settings Selecting this parameter from the **Measure** menu displays hysteresis and level percent menus. The associated fields allow you to set values in those menus: a specified number of vertical divisions or a percentage of the peak-to-peak height of the local feature.

Example

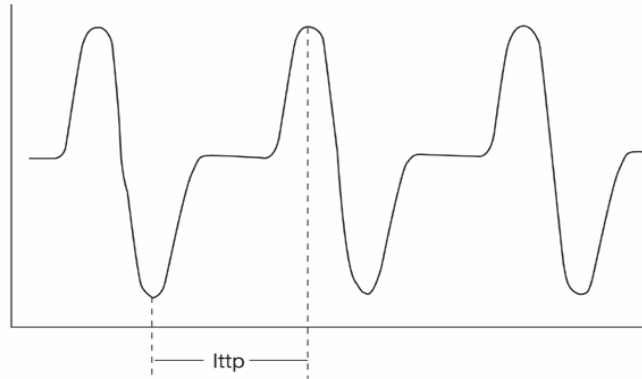

Itut

Local Time Under Threshold

Definition The time a local feature spends under a user-specified percentage of its peak-to-trough amplitude.

Description The peak-to-trough height of a local feature is measured. The time the local feature spends under a user-specified percentage of this height is determined, and the average for all the waveform's local features is displayed as Itut. Provided for histograms is the time spent under the threshold by each local feature between the parameter cursors.

Parameter Settings Selecting this parameter from the **Measure** menu displays hysteresis and level percent menus. The associated fields allow you to set values in those menus: a specified number of vertical divisions or a percentage of the peak-to-peak height of the local feature.

Example

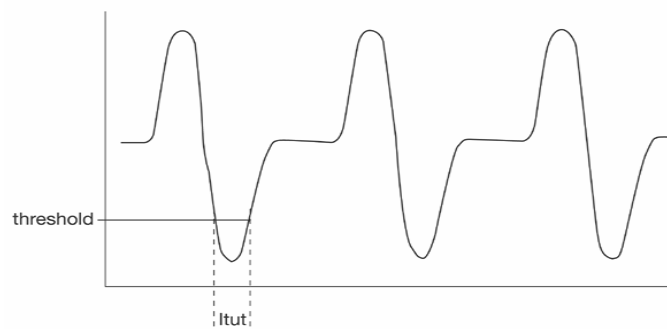

Disk Standard Parameters

These parameters enable standard disk drive waveform parameter measurements. These parameters are accessible by touching **Measure** in the menu bar, then touching the **My Measure** button, and then a parameter button: P1 to P8.

DISK STANDARD PARAMETER	DEFINITION
aasym	amplitude asymmetry between taa+ and taa-
p@lv	period of each cycle in an acquired waveform, called Jitter in the parameter menu
nbph	narrow band phase of waveform Discrete Fourier Transform (DFT)
nbpw	narrow band power of waveform Discrete Fourier Transform (DFT)
owrt	overwrite
pw50	pulse width of peaks at 50% amplitude from baseline
pw50+	pulse width of positive peaks at 50% amplitude from baseline
pw50-	pulse width of negative peaks at 50% amplitude from baseline
res	resolution
taa	track average amplitude
taa+	track average amplitude of positive peaks from baseline
taa-	track average amplitude of negative peaks from baseline

All disk standard parameters except nbph, nbpw, owrt and p@lv make their measurements on waveform peak-trough pairs. In addition, several of the parameters determine the baseline of peak-trough pairs in order to perform their calculations.

Note: The DDAs variable hysteresis setting is essential for identifying peak-trough pairs.

ampl asym	Amplitude Asymmetry
Definition	$aasym = 1 [(taa+ - taa-) / (taa+ + taa-)]$
Description	For a perfectly symmetric waveform, aasym=1. If any one side of the waveform is missing, aasym=0.
Parameter Settings	Selecting this parameter displays a hysteresis-dialog for setting the hysteresis value to a specified number of vertical divisions.

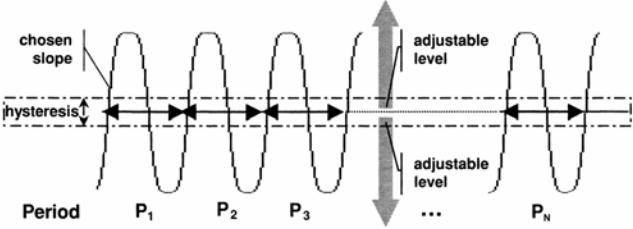
p@lv	Period at Level
Definition	Calculates the period of each cycle in an acquired waveform
Description	For each cycle in a waveform, p@lv determines the time from the beginning of the cycle as defined by a user specified threshold and slope to the end of the cycle as shown in the diagram below.
Parameter Settings	<p>Selecting this parameter accesses a dialog to set hysteresis, level and slope. A hysteresis value defines the hysteresis, in divisions. That is, a voltage band is extended equidistantly above and below the selected level. In order for the signal to be considered valid, and not as noise, the signal must exceed the upper or lower limits of this band by half the hysteresis-division setting.</p>  <p>The diagram shows a periodic waveform with several cycles. A horizontal dashed line represents the 'adjustable level'. Two vertical arrows pointing up and down from this level represent the 'hysteresis' band. The waveform crosses the upper and lower bounds of this band. The time between the start of one cycle and the start of the next is labeled as 'Period'. The first three periods are labeled P₁, P₂, and P₃, followed by an ellipsis and P_N. A 'chosen slope' is indicated by a vertical line and arrow at the start of a cycle. The 'adjustable level' is also labeled on both sides of the hysteresis band.</p>

nbph	Narrow Band Phase
Definition	Provides a measurement of the phase at a specific frequency for a waveform.
Description	<p>nbph is the phase of the Discrete Fourier Transform (DFT) computed on a waveform at a specific frequency. The result is the phase of the corresponding frequency sine wave component of the waveform at the first data point between the parameter cursors. The nbph parameter calculates one bin of a DFT centered at the frequency provided. The bin width is 0.105% of the frequency selected if the waveform trace displayed by the DDA is $960 \times (1/\text{frequency})$ or more in length (i.e., the trace is equal to or longer than 960 cycles of a waveform at the selected frequency). Otherwise, the bin width is:</p> $100 / \text{integer}[(\text{trace length})/(1/\text{frequency})] \%$ <p>where integer[] designates discarding any fractional portions in the result. Thus, if the waveform trace is 48.5 times longer than $1/\text{frequency}$, the bin width will be:</p> $100/48 = 2.1\% \text{ of the selected frequency.}$ <p>nbph is very sensitive to frequency, and it is important that the frequency value provided be as accurate as possible if accurate results are to be obtained.</p>
Parameter Settings	Selecting this parameter accesses a frequency setting dialog.

nbpw	Narrow Band Power												
Definition	Provides a measurement of the power at a specific frequency for a waveform.												
Description	<p>nbpw is the magnitude of the Discrete Fourier Transform (DFT) computed on a waveform at a specific frequency. nbpw calculates one bin of a DFT centered at the frequency provided. The bin width is 0.105% of the frequency selected if the waveform trace on the DDA is 960* (1/frequency) or more in length (i.e. the trace is equal to or longer than 960 cycles of a waveform at the selected frequency). Otherwise, the bin width is:</p> $100 / \text{integer}[\text{trace length}/(1/\text{frequency})] \%$ <p>where integer[] designates discarding any fractional portions in the result. Thus, if the waveform trace is 48.5 times longer than 1/frequency then the bin width will be:</p> $100/48 = 2.1\% \text{ of the selected frequency.}$ <p>A Blackman-Harris window is applied to the input data to minimize leakage effects. The net result is that nbpw will provide excellent results even if frequency changes occur due to spindle speed variations. If the actual frequency differs from the specified frequency, and the bin width is 0.105% (minimum resolution bandwidth), the resulting power will be reduced from the actual as in this table:</p> <table border="0"> <tr> <td colspan="2">Frequency Difference</td> <td colspan="2">dB Reduction</td> </tr> <tr> <td>0.03%</td> <td>0.06%</td> <td>0.3 dB</td> <td>1.1 dB</td> </tr> <tr> <td>0.1%</td> <td></td> <td>3 dB</td> <td></td> </tr> </table> <p>If the bin width is greater than 0.105%, the frequency difference for which a specified dB reduction will occur will scale proportionally to the bin width/0.105.</p> <p>nbpw results are presented in dBm.</p>	Frequency Difference		dB Reduction		0.03%	0.06%	0.3 dB	1.1 dB	0.1%		3 dB	
Frequency Difference		dB Reduction											
0.03%	0.06%	0.3 dB	1.1 dB										
0.1%		3 dB											
Parameter Settings	Selecting this parameter accesses a frequency setting dialog.												

owrt	Overwrite
Definition	The ratio of residual to original power of a low-frequency disk waveform overwritten by a higher frequency waveform.
Description	<p>owrt measures the residual power of a low-frequency LF waveform after it has been overwritten by a high-frequency HF waveform. The LF waveform should be stored to memory (M1-M4). The HF waveform can then be input to the DDA, and overwrite calculated where:</p> $\text{owrt} = 20 \log (V_r/V_o),$ <p>where V_r is the residual V_{rms} of the sine wave component of the HF waveform at the LF base frequency after the HF waveform write, and V_o is the V_{rms} of the sine wave component of the LF waveform at the LF base frequency. The calculation is performed by the DDA making a narrow-band power measurement (see nbpw parameter description) at LF, for both the HF and LF waveforms, and subtracting the second result from the first. A menu enables the choice of which waveform, HF or LF, is assigned to which DDA channel or trace (1, 2, 3, 4, M1 to M4, or F1 to F8). The menu button is used to set the input for HF or LF, while the input for the selected waveform is set with the associated knob. The owrt results are presented in dB. All averaging, including statistics and trend average, is performed on linear units. Average results are converted to dB.</p> <p>Note: In typical use, it is preferable to use nbpw to measure the LF waveform, and then the residual LF in the HF separately, instead of the owrt parameter. Overwrite is the difference between the nbpw readings in dB. There are two reasons why this is preferable: 1) nbpw, with statistics on, provides average power readings. With owrt the low frequency signal is typically a stored single-shot acquisition due to the difficulty finding a suitable trigger for time domain averaging of a head signal. 2) owrt computes both nbpw results each time. If the LF is stored, this is not necessary. So nbpw will take twice as many acquisitions as owrt and achieve a more stable average result in the same amount of time.</p>
Parameter Settings	Selecting this parameter accesses a frequency setting dialog. This frequency is used to calculate nbpw for both the HF and LF waveforms. If a large number of digits is used, selection of the exact frequency may be difficult. In this case, a number with fewer digits and less precision should be chosen for the approximate frequency, then the precision should be increased as desired and the exact value chosen.

pw50	Pulse Width 50
Definition	The average pulse width at the 50% point between a local baseline and the local-feature peak, and between the local baseline and the local feature-trough.
Description	All local features between the parameter cursors for an input waveform are identified. The local baseline is identified for each feature, and the height between the local baseline and the peak is determined. The pulse width is measured at 50% of the peak. The same measurement is then performed for the trough. The average of all width measurements is displayed as pw50. Provided for histograms is the average pw50 value for each local feature between the parameter cursors.
Parameter Settings	Selecting this parameter displays a hysteresis-dialog for setting the hysteresis value to a specified number of vertical divisions.

pw50-	Pulse Width 50-
Definition	The average pulse width measured at the 50% point between the local feature baseline and the local feature trough.
Description	All local features between the parameter cursors for an input waveform are identified. The local baseline is identified for each feature, and the height between the local baseline and trough is determined. The pulse width is measured at 50% of the trough amplitude. The average of all width measurements is displayed as pw50. Provided for histograms is the average pw50 value for each local feature between the parameter cursors.
Parameter Settings	Selecting this parameter displays a hysteresis-dialog for setting the hysteresis value to a specified number of vertical divisions.

pw50+	Pulse Width 50+
Definition	The average pulse width at the 50% point between the local feature baseline and the local feature peak.
Description	All local features between the parameter cursors for an input waveform are identified. The local baseline is identified for each feature, and the height between the local baseline and peak is determined. The pulse width is measured at 50% of the peak amplitude. The average of all width measurements is displayed as pw50+. Provided for histograms is the average pw50+ value for each local feature between the parameter cursors.
Parameter Settings	Selecting this parameter displays a hysteresis-dialog for setting the hysteresis value to a specified number of vertical divisions.

res	Resolution
Definition	The ratio of the track average amplitude for a high and low frequency waveform.
Description	res returns, as a percentage, the ratio of track average amplitude (see taa parameter description) for a low frequency LF and high frequency HF waveform: $\text{res} = (\text{taa}(\text{LF}) / \text{taa}(\text{HF})) * 100\%.$
Parameter Settings	Selecting this parameter displays a hysteresis-dialog for setting the hysteresis value to a specified number of vertical divisions.

taa	Track Average Amplitude
Definition	The average peak-to-trough amplitude for all local features.
Description	All local features between the parameter cursors for an input waveform are identified. The peak-to-trough amplitude is determined for each feature, and the average is returned as taa. Provided for histograms is the peak-to-trough amplitude for each local feature between the parameter cursors.
Parameter Settings	Selecting this parameter displays a hysteresis-dialog for setting the hysteresis value to a specified number of vertical divisions.

taa-	Track Average Amplitude-
Definition	The average local baseline-to-trough amplitude for all local features.

Description	All local features between the parameter cursors for an input waveform are identified. The local baseline-to-trough amplitude is determined for each feature, and the average is returned as taa. Provided for histograms is the local baseline-to-trough amplitude for each local feature between the parameter cursors.
Parameter Settings	Selecting this parameter displays a hysteresis-dialog for setting the hysteresis value to a specified number of vertical divisions.

taa+	Track Average Amplitude+
Definition	The average local baseline-to-peak amplitude for all local features.
Description	All local features between the parameter cursors for an input waveform are identified. The local baseline-to-peak amplitude is determined for each feature, and the average is returned as taa+. Provided for histograms is the local baseline-to-peak amplitude for each local feature between the parameter cursors.
Parameter Settings	Selecting this parameter displays a hysteresis-dialog for setting the hysteresis value to a specified number of vertical divisions.

Disk PRML Parameters

These enable parameter measurements of auto-correlation signal-to-noise (ACSN) and non-linear transition shift (NLTS). The calculation of both parameters is based on a correlation math function.

- **ACSN** can be applied to any periodic waveform. Since these waveforms are by definition identical in every period, any deviation is due to uncorrelated noise sources. By performing an auto-correlation calculation of the waveform over successive periods, the level of less-than-perfect correlation can be measured. With this measurement, the noise level can be derived by ACSN. (See ACSN description.)
- **NLTS** offers the ability to measure all echoes in the auto-correlation calculation of a disk waveform. This includes the NLTS (adjacent location), second adjacent location, and overwrite (initial magnetization) echoes. The parameter performs NLTS averaging, pattern length searching, and limit checking to reduce the effects of noise and to ensure accurate measurements. (See NLTS description.)

Correlation Theory of Operation

The DDAs correlation function measures the correlation between one section of a waveform and other sections of the same waveform having the same length, or between a section and sections of equal length belonging to another waveform.

When the correlation is performed on the same waveform it is called an auto-correlation. If the shape of two waveform sections are identical, the correlation value will be maximized.

The DDA normalizes correlation values to ± 1 , with 1 indicating that the waveform sections are identical, -1 that the sections are inverted from each other, and 0 that there is no correlation.

Noiseless periodic waveforms will have perfect correlation (a correlation value of 1) when performing auto-correlation, and when the start of the second section is an integer number of periods later than the start of the first section.

Correlation values can be calculated as a function of various amounts of time shift between two waveform sections used in calculating a correlation. This calculation, as a function of the starting point of the second section being the i^{th} waveform sample, is determined by:

$$\text{mean}() = \sum_{x=a}^b \text{wave}_x / (b - a)$$
$$\text{variance}(\text{wave}_a^b) = \frac{\sum_{x=a}^b (\text{wave}_x)^2}{b - a} - \text{mean}(\text{wave}_a^b)^2$$

$$\text{Corr}_i = \frac{\left(\sum_{j=0}^N \text{wave1}_j * \text{wave2}_{i+j} / (N+1) \right) - \text{mean}(\text{wave1}_0^N) * \text{mean}(\text{wave2}_i^{N+i})}{\sqrt{\text{variance}(\text{wave1}_0^N) * \text{variance}(\text{wave2}_i^{N+i})}}$$

where Corr_i is the i^{th} sample point (starting from 0) of the correlation waveform, wave1_j is the j^{th} sample of the first waveform, wave2 is the second input waveform (wave1 in an auto-correlation), and wave_a^b is a section of a waveform from sample a to sample b . The upper bound N in the summations determines the length (length is $N+1$ sample points, since the first sample is point 0) of the waveform sections on which the correlation calculation is performed. The divisor in the correlation function:

$$\sqrt{\text{variance}(\text{wave1}_0^N) * \text{variance}(\text{wave2}_i^{N+i})}$$

normalizes the correlation calculation to ± 1 , while the

$$\text{mean}(\text{wave1}_0^N) * \text{mean}(\text{wave2}_i^{N+i})$$

term in the dividend removes any effect due to DC offset of the input waveforms in the correlation function.

Essentially, the correlation waveform function takes a section of the first waveform and calculates how it correlates with an equal-length section of a second waveform, using different starting points in the second waveform. This can be visualized as taking a section of waveform 1, sliding it over waveform 2, and calculating the correlation value for the area that overlaps. The bounds of the starting point are from the beginning of the second waveform to its length, minus the section length. At the upper bound, the end of the first waveform section lies at the last sample point of the second waveform. Because the length of waveforms in the DDA is limited to 10 divisions, the upper bound of the correlation function is 10 divisions minus the section length in divisions.

acsn	Auto-Correlation Signal-to-Noise
Definition	Provides a signal-to-noise ratio for periodic waveforms.
Description	<p>Using the DDA's correlation function, acsn provides a measurement of the auto-correlation signal-to-noise for a repetitive waveform. At least two waveform repetitions need to be acquired in order to calculate acsn. In addition, the period of the waveform must be specified.</p> <p>Selecting this parameter displays a hysteresis-dialog for setting the hysteresis value to a specified number of vertical divisions.</p> <p>The parameter then verifies, and may adjust, the period based on the value provided. This is crucial because variations in disk rotation speed make the exact length of time for a disk waveform difficult to determine.</p> <p>Using the period as a starting point, the DDA performs an auto-correlation and looks for an auto-correlation peak at the period. At the top of the peak, the pattern repeats. The DDA locates the top and notes the corresponding time so that it can determine the period. Then it recalculates the auto-correlation using this period. The value of the auto-correlation at the period peak, R, is used to calculate the ACSN as:</p> $S/N = R/(1R),$ $ACSN = 10 * \log_{10} S/N.$ <p>For greater accuracy, the instrument averages several ACSN measurements when calculating acsn. An ACSN measurement is performed for each pattern, and the results averaged.</p> <p>All individual ACSN measurements can be observed by histogramming the acsn parameter. ACSN is limited to measuring signal-to-noise ratios of 9.6 dB or greater.</p> <p>ACSN results are presented in dB. All averaging, including statistics and trend average, is performed on linear units. Averaged results are then converted to dB.</p>

Parameter Settings	<p>When you select acsn from the PRML dialog's With parameter field (DRIVE ANALYSIS → Measure → Parameter Set → PRML) an acsn Pattern Length field appears also.</p> <p>The pattern length should be set as an integral number of waveform periods, and must be at least 50 samples at the DDA's sample rate. (The sample rate is shown in the TimeBase label box.) Because these periods will be correlated with the same number of following periods, the pattern length must be no more than half the number of full periods available in the sweep.</p> <p>Notes on How Settings Affect ACSN Measurement</p> <p>Pattern length should be close enough to the signal period (or multiple thereof) that it is on the correlation peak. The code measures correlation at 3 positions: the length, 6 samples less and 6 samples more. It will walk up a slope until the center sample is highest, tighten the spacing until the two side positions have correlation above half the correlation at the center position, and eventually perform a parabolic fit. But if pattern length misses the peak entirely then this search may not work if the smallest of the three correlations is at the center and the two side position correlations are equal, it stops. For a sinusoidal signal, almost any setting of pattern length should work.</p> <p>One limitation to know about at this stage: the code checks for a "reasonable" peak. The correlation at the center position must be > 0.9, or the parameter computation is canceled. This is done without the benefit of the parabolic fit, but the intent is only to make sure of a reasonable peak.</p> <p>The total number of cycles in the acquisition does not affect the ACSN result for a stationary signal. Note that horizontal scale and the Max Sample Points entry on the TIMEBASE "Smart Memory" dialog interact. As you increase the time of an acquisition, the sample rate may decrease to keep the acquisition smaller than Max Sample Points. Although ACSN is not affected by horizontal scale, it is affected by sample rate. Be sure to keep it high enough.</p> <p>For the same signal, ACSN will fall as vertical scale is increased, because the signal fills less of the code space of the ADC and is therefore more contaminated by quantization noise and any other internal noise. In general, when displayed on a channel (or a reset trace), the signal should fill as much of the grid vertically as possible, but should never clip against the top or bottom of the grid. If high ACSN readings (greater than or equal to 30 dB) are expected, this is especially important.</p> <p>The pattern length should be kept to the minimum number of cycles that will satisfy the 50 samples per pattern requirement. In general, with a somewhat noisy signal, as the number of cycles in one pattern length is increased, ACSN is slightly reduced. For example, with an 80 MHz 75 mV sine wave with 0.6% (of p-p) rms noise, sampled at 1GS/s, acsn result varied with pattern length as follows:</p>
--------------------	--

Pattern Length (Seconds)	Cycles in One Pattern Length	ACSN
5.00E-8	4	27.54 dB
6.25E-8	5	26.97 dB
7.50E-8	6	26.78 dB
8.75E-8	7	26.57 dB
1.000E-7	8	26.47 dB
1.125E-7	9	26.41 dB
1.250E-7	10	26.30 dB

As ACSN readings get higher, small amounts of noise cause greater changes in dB. This is because high readings mean correlation was very close to 1.

Examples:

Correlation	ACSN
.9995	33.0 dB
.9990	30.0 dB
.9985	28.2 dB
.9980	27.0 dB
.9975	26.0 dB
.9970	25.2 dB

nlt s	Non-Linear Transition Shift
Definition	Provides a measurement of the nonlinear transition shift for a disk drive signal.
Description	<p>Using the DDA's correlation function, nlts measures the nonlinear transition (adjacent location) shift. At least two full cycles of the test sequence are required for the auto-correlation. In addition, the period of the waveform must be specified.</p> <p>The parameter then verifies, and may adjust, the pattern length based on the value provided. This is crucial, because variations in disk rotation speed make the exact pattern length for a disk waveform difficult to determine.</p> <p>Using the pattern length as a starting point, the DDA looks for an auto-correlation peak at the length. At the top of the peak, the pattern repeats. The DDA locates the top, and notes the corresponding time so as to determine the exact pattern length. Then it recalculates the auto-correlation, using this length. If the value of the auto-correlation peak at the pattern length is less than 0.9, the NLTS is not calculated. This is because the pattern-length sections will be too uncorrelated to provide a meaningful result. Otherwise, the pattern length value is used to calculate nlts. Using the pattern delay value, the DDA measures the auto-correlation coefficient for the first pattern-length chunk of the input waveform with a second pattern-length chunk, starting from the beginning of the input waveform at the delay value.</p> <p>In order to correctly calculate nlts, the disk drive waveform must be a pseudorandom sequence that will create an echo in an auto-correlation calculation, corresponding to the non-linear transition shift. Typically, this waveform is a 127-bit pattern based on an $x^7 + x^3 + 1$ polynomial; and the NLTS echo appears at a pattern delay of 20.06% of the input pattern length. Ideally, the value of NLTS is:</p> $\text{NLTS(\%)} = 200 * \text{Correlation Coefficient (at delay)}.$ <p>However, because noise in the input waveform can affect the correlation coefficients value, the DDA averages several NLTS measurements to reduce the effect of noise. An NLTS measurement is performed for each pattern, and the results averaged. All the individual NLTS measurements can be observed by histogramming the nlts parameter.</p> <p>The greater the number of pseudorandom pattern periods in the input waveform, the greater the reduction in the effect of noise on the nlts result. In order to further reduce the impact of noise, the NLTS calculations are adjusted by dividing their value by the correlation coefficient value at an integral number of pattern-length delays.</p> <p>The following table gives the standard deviation of the nlts parameter for varying amounts of auto-correlation signal-to-noise, and numbers of repetitions of the pseudorandom sequence in the input waveform. The sampling rate used was four samples/bit cell, and the input waveform had 20% NLTS.</p>

ACSN	#Pattern Repetitions	nIts Standard Deviation
26 dB	2	0.44 %
	10	0.28 %
	25	0.20 %
23 dB	2	0.59 %
	10	0.32 %
	25	0.26 %
20 dB	2	0.65 %
	10	0.42 %
	25	0.28 %
17 dB	2	1.08 %
	10	0.57 %
	25	0.35 %

Parameter Settings	<p>When you select nlts from the PRML dialog's With parameter field (DRIVE ANALYSIS → Measure → Parameter Set → PRML) an nlts Pattern Length field and pattern Delay field appear also. You can adjust the mantissa, exponent or number of mantissa digits using the pop-up numeric keypad. The pattern length should be set to the pattern period.</p> <p>Although the DDA searches for the correct pattern length, the value provided needs to be sufficiently close to the actual pattern length for nlts to perform the search. A 1 μs pattern may, for example, accept a range of 1 μs ± 40 ns. Within this range, a value for nlts will be provided. Otherwise "---" appears on the screen, indicating that no measurement can be made.</p> <p>The pattern Delay setting is a percentage of the pattern length. The DDA will internally scale the delay value entered by the ratio of the pattern length calculated internally to the pattern entered by you. Several disk drive waveform attributes can be measured by using different delay values. The following table provides delay values to enter for the commonly used 127-bit pseudo-random sequence ($x^7 + x^3 + 1$ polynomial) when measuring various waveform attributes:</p> <table border="1" style="margin: 10px auto; border-collapse: collapse; text-align: center;"> <thead> <tr> <th style="padding: 5px;">Waveform Attribute</th> <th style="padding: 5px;">Bit Cell Location</th> <th style="padding: 5px;">Delay (%)</th> </tr> </thead> <tbody> <tr> <td style="padding: 5px;">Adjacent Location</td> <td style="padding: 5px;">25.5</td> <td style="padding: 5px;">20.08%</td> </tr> <tr> <td style="padding: 5px;">2nd Adjacent Location</td> <td style="padding: 5px;">-30.5</td> <td style="padding: 5px;">-24.02%</td> </tr> <tr> <td style="padding: 5px;">Initial Magnetization</td> <td style="padding: 5px;">45.5</td> <td style="padding: 5px;">35.83%</td> </tr> <tr> <td style="padding: 5px;">Interaction Interference</td> <td style="padding: 5px;">-60.5</td> <td style="padding: 5px;">-47.64%</td> </tr> </tbody> </table> <p>Notes</p> <p>The pattern Delay tells the DDA where in the repeating pattern to measure NLTS. NLTS is calculated from the correlation coefficient at that time. Correlation is calculated at 3 sample times: the nearest sample time and one on each side. A curve fit is performed to calculate a better estimate of the true peak height.</p> <p>As described above, the nlts parameter only requires one waveform. Each acquisition must contain only the pseudorandom repeating sequence (PRS), not a servo wedge or a preamble. It does not matter where in the PRS the acquisition begins; its echo properties are independent of starting point. There must be at least two repetitions of the pattern in each acquisition. A reasonable number would be about 25 repetitions (32 repetitions of a 127-bit sequence should fit in a sector).</p> <p>NLTS requires at least 5 samples per PW50 for acceptable accuracy. More is better.</p>	Waveform Attribute	Bit Cell Location	Delay (%)	Adjacent Location	25.5	20.08%	2nd Adjacent Location	-30.5	-24.02%	Initial Magnetization	45.5	35.83%	Interaction Interference	-60.5	-47.64%
Waveform Attribute	Bit Cell Location	Delay (%)														
Adjacent Location	25.5	20.08%														
2nd Adjacent Location	-30.5	-24.02%														
Initial Magnetization	45.5	35.83%														
Interaction Interference	-60.5	-47.64%														

The PRS data must correspond to the transitions on the media. This means it must be written in direct write mode; it must not be scrambled or encoded.

NLTS calculated by correlation techniques and by the fifth harmonic elimination techniques do correlate, but they are not identical. Fifth harmonic elimination uses a pattern including only dibits and widely spaced transitions. Of course, a dibit is the worst case for NLTS. The pseudorandom pattern has some dibits, some tribits, some transitions 1 apart, etc. The reading that any method based on a PRS comes up with is affected by all of the pattern. This tends to make the correlation method come up with a somewhat lower value than fifth harmonic. That is the better value to look at when determining write precomp, since the PRS is a lot like real data.

The fifth harmonic method is not sensitive to amplitude asymmetry. Its drawbacks are

- If the fifth harmonic is small, noise will tend to inflate the value read: for 20 dB SNR it may not be possible to read below 10% nlts
- Amplitude loss due to partial erasure will contribute to the fifth harmonic about as much as actual NLTS.

The correlation method is less sensitive to amplitude loss due to partial erasure: one reference cites experiments showing that 25% nlts and 25% amplitude loss only inflates the nlts reading to 30%.

However, it is more sensitive to PW50/T ratio (it is most accurate at high ratio, approaching 3.0). Partial erasure and hard/easy transition shift (due to DC erase) creates separate correlation echo peaks which, depending on the pattern used, may be close to the adjacent transition **nlts** echo and interfere. It is important to pick a good PRS.

Noise Parameters

Disk noise parameters enable parameter measurements of media signal-to-noise (msnr), residual (electronics) signal-to-noise (rsnr), and the ratio of media to residual signal-to-noise (m_to_r). The calculation of all three parameters is based on the distribution of the averaged Viterbi input samples.

- **msnr** can be applied to any single-frequency, sector-based data pattern. The single-frequency data will be sampled at the peaks (maxima), zero crossings, and troughs (minima). Any deviations from the ideal sample points will be a result of noise. By performing multiple reads, random noise can be averaged away. With this measurement, the repeating media noise level can be derived by msnr.
- **rsnr** can be applied to any single-frequency, sector-based data pattern. The single-frequency data will be sampled at the peaks (maxima), zero-crossings, and troughs (minima). Any deviations from the ideal sample points will be a result of noise. By performing multiple reads, random noise can be quantified. With this measurement, the non-repeating residual (electronics) noise level can be derived by rsnr.
- **m_to_r** can be applied to any single-frequency, sector-based data pattern. The m
- snr is compared with the rsnr. The resulting ratio indicates whether the signal is dominated by media noise if it is greater than 1.00, or dominated by residual (electronics) noise if less than 1.00.

Note: Although the math on the following pages is simplified by assuming a large number of sweeps, inside the DDA it calculates what the final value should be from 2 or more sweeps. The value will become more stable as more sweeps are taken, but its mean should not change. Therefore, a large number of sweeps is not required for unbiased values.

msnr	Media Signal-to-Noise Ratio
Definition	Provides a signal-to-noise ratio for single-frequency, sector-based waveforms.
Description	<p>Granularity in magnetic media produces zigzag transitions. The exact location of the zigzags changes from write to write causing media noise (also known as zigzag noise). During read operations, the read head effectively averages across the track the location of all the zigzags. If the recorded track width is wide, there are many zigzags and very little variability in the averaged transition location. If the track width is narrow, there are fewer zigzags, and the variability in the averaged transition location increases.</p> <p>Head signal amplitude is approximately proportional to track width. Media noise is approximately proportional to the square root of the track width. Therefore, the ratio of the head signal to the media noise (msnr) is proportional to the square root of the track width. As track widths continue to decrease, msnr will get worse. Although advanced head technology (i.e., MJR and GMR) can increase the head signal output for a given track width, the effect of media noise on the head signal is also increased so there is no improvement in msnr. As track widths decrease, msnr will continue to increase despite greatly improved head technology.</p> <p>By using single-frequency data, the algorithm is able to focus on the peaks, the zero-crossings, and the troughs. The ideal Viterbi input samples are therefore +1, 0, and -1. Deviations from the ideal are quantified and graphed. The squared sigma of the total noise distribution is equal to the squared sigma of the media noise distribution. This relationship is always true:</p> $\sigma_t^2 = \sigma_m^2 + \sigma_r^2$ <p>For a large number of samples:</p> $\sigma_m^2 = \sigma_a^2$ $\sigma_r^2 = \sigma_t^2 - \sigma_a^2$ <p>Once the distribution of the media noise has been calculated, the msnr is then calculated by:</p> $\text{msnr} = 20 \log(v_{0-p}/\sigma_m)$
Parameter Settings	After specifying the location of the “Head Signal” and the optional “Read Gate,” selection of msnr is automatic after you touch the Noise Analysis button. Touch the Setup for Single Frequency button to initialize the measurement.

rsnr	Residual Signal-to-Noise Ratio
Definition	Provides a residual signal-to-noise ratio for single-frequency, sector-based waveforms.
Description	<p>Residual noise is the random noise present on a disk drive signal from read to read.</p> <p>By using single-frequency data, the algorithm is able to focus on the peaks, zero-crossings, and the troughs. The ideal Viterbi input samples are therefore +1, 0, and -1. Deviations from the ideal are quantified and graphed. The squared sigma of the total noise distribution is equal to the squared sigma of the media noise distribution and the squared sigma of the residual noise distribution. This relationship is always true:</p> $\sigma_t^2 = \sigma_m^2 + \sigma_r^2$ <p>For a large number of samples:</p> $\sigma_m^2 = \sigma_a^2$ $\sigma_r^2 = \sigma_t^2 - \sigma_a^2$ <p>Once the distribution of the media noise has been calculated, the rsnr is then calculated by:</p> $\text{rsnr} = 20 \log(v_{0-p}/\sigma_r)$
Parameter Settings	After specifying the location of the "Head Signal" and the optional "Read Gate," selection of rsnr is automatic after you touch the Noise Analysis button. Touch the Setup for Single Frequency button to initialize the measurement.

m_to_r	MSNR-to-RSNR Ratio
Definition	Provides a media signal-to-noise residual to signal-to-noise ratio for single-frequency, sector-based waveforms.
Description	<p>The m_to_r ratio provides a quick measurement to compare the media noise with the residual noise. If this ratio is greater than 1.00, the signal is residual, or electronics noise dominated.</p> <p>The measurement is calculated by:</p> $m_to_r = \sigma_m/\sigma_r$
Parameter Settings	After specifying the location of the "Head Signal" and the optional "Read Gate," selection of m_to_r is automatic after you touch the Noise Analysis button. Touch the Setup for Single Frequency button to initialize the measurement.

PRML Channel Emulation

This introduction to PRML and its concepts explains the role of the PRML channel chip components. It describes how the Channel Emulation feature of the Disk Drive Analyzer works together with them using equalization, clock and gain recovery, maximum likelihood detection, sequenced amplitude margin, and encoding and error detection.

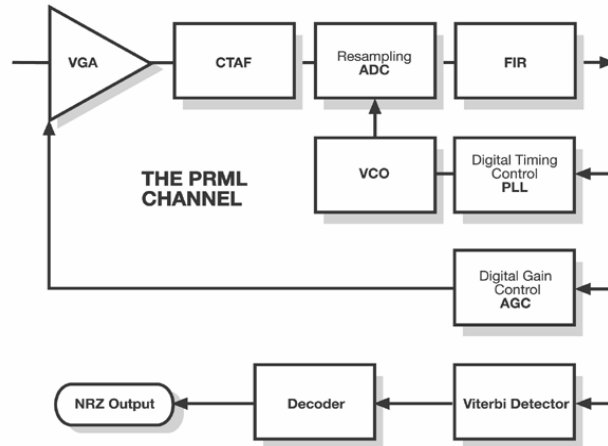

Why PRML?

For the remarkable gains in disk drive capacity to continue, media and head performance improvements are no longer enough. Faced with equally impressive advances in semiconductor technology, disk drive engineers have been working to create a new read-channel architecture that will allow capacity to grow unimpeded.

The answer lies in the construction of the disk itself. The disk's magnetic poles, with two orientations possible along the track, store the bits as "0" and "1". When the drive reads, the head detects the transition from one pole to another --- as bit "0" to bit "1", for instance. If such transitions are "far away," or low-density, the drive will see isolated pulses. But to increase density, the pulses can be made shorter and placed closer together or kept wide but overlapping. While the first of these alternatives, represented by Peak-Detect systems, has reached its limits, the second, Partial-Response Maximum Likelihood (PRML), has allowed the industry to go on boosting capacity.

The overlapping pulses of partial-response systems allow much greater density. PRML systems have more samples per pw50, which is defined as the width of an isolated pulse at 50% of its amplitude. And the more complex, or higher-order, the PRML system, the greater the density that can be obtained. Comparing typical values achieved by available PRML systems with Peak-Detect we find:

Density of Samples per pw50	
Peak Detect	1
PRML	
PR4	1.65
EPR4	2
E2PR4	2.31

However, the higher order PRML schemes need very complex circuits and decoders. While the Class IV partial response (PR4) system works with three vertical levels of samples, extended partial response 4 (E2PR4) has seven levels, and requires not only a higher resolution of ADC, but a complicated timing and gain recovery circuit and sophisticated ML detector as well. Another disadvantage of the more complex PRML schemes is that they are more sensitive to noise.

Principle of Equalization

The process of taking the more-or-less Lorentzian shaped head response to a magnetic transition and turning it into a correctly shaped pulse is called equalization. This is of great importance, due to the need of the Viterbi detector inside the PRML channel chip for correctly shaped pulses. Essentially, equalization is performed in the read channel chip by a continuous time analog filter (CTAF).

Noise must be eliminated before sampling occurs, or else it becomes impossible to separate it from the head signal. Since the head signal is typically noisy, and contains pulses that are not quite the desired shape, the DDA provides an equalization filter to reduce much of the noise and reshape the pulses before it processes the waveform. This filter is a digital implementation of a seven-pole, two-zero equiripple filter.

When you are using the filter, there are a number of parameters to be set. If the head signal has already been acquired, the filter parameters can be set automatically by pressing the **Train Filter** button. When this button is pressed:

- If the signal type is Peak Detect, the boost is set to zero and the -3 dB frequency is set to:

$$\frac{1}{\text{bit cell time}}$$

- If the signal type is PRML (PR4, EPR4 or E2PR4) the -3 dB frequency is set to:

$$\frac{0.5}{\text{bit cell time}}$$

The best boost and -3 dB frequency are found by optimizing boost at the default -3 dB frequency, then optimizing -3 dB at the better boost. Then optimize boost at the new -3 dB frequency, and optimize -3 dB frequency again at the new boost. And then, if -3 dB frequency has changed by more than a small amount, optimize the boost one final time. The goal for optimization is to maximize the mean of the 100 worst SAM values. A typical run will recompute the filter, apply it, and

run the Viterbi detector on the filtered waveform fifteen to twenty times. While the filter training is in progress, a message is displayed showing the last boost and -3 dB settings and the mean of the 100 worst SAM values at that setting.

The result of training is a close approximation to the best settings for our digital version of a CTAF on the current acquisition, using the current setup of the FIR. The cleaner the waveform, the better the approximation will be. The filter should be trained on a signal from a good read, those settings can be used for all reads in the same zone.

Train Filter should be done with the acquisition stopped (press STOP on the DDA), so that the same waveform is worked on each time; otherwise the search may be slow to converge. **Train Filter** can take a significant amount of time, and it is recommended that it be done on relatively short waveforms of 50 or 100 kpoints. Once trained, the memory length can be adjusted to the desired length. To ensure that the group delay is flat, the filter requires at least five samples per bit cell. This is not a hard limit, but performance will degrade with fewer than five samples per bit cell.

Alternatively, you can adjust the filter settings manually.

-3 dB Frequency

This is the actual -3 dB frequency of the filter. In most implementations of frequency cutoff (f_c), the -3 dB point, if Boost is 0 dB and group delay is 0%, is controlled by you. It is understood that the real -3 dB frequency will be higher by some factor that depends on Boost and Group delay settings. Therefore changing Boost or Group delay requires changing " f_c " in order to keep the -3 dB point in the same place.

The DDA does this work automatically: you set the desired -3 dB frequency, and the DDA calculates f_c for the current Boost and Group delay.

The frequency cutoff accuracy ($\alpha = 0$) is $< 2\%$ of the setting.

Boost at f_c

The pulse shape produced by a transition going under a head is nearly Lorentzian, but that is not the correct shape for PRML. Boosting the gain at high frequencies makes the pulses slimmer and eliminates the long tails they would otherwise have. The perfect (mathematically created) shape that an isolated pulse should have is illustrated below, for PR4, EPR4 and E2PR4. Note that the vertical lines show when the channel samples the waveform.

The boost accuracy is within 0.5 dB of the setting:

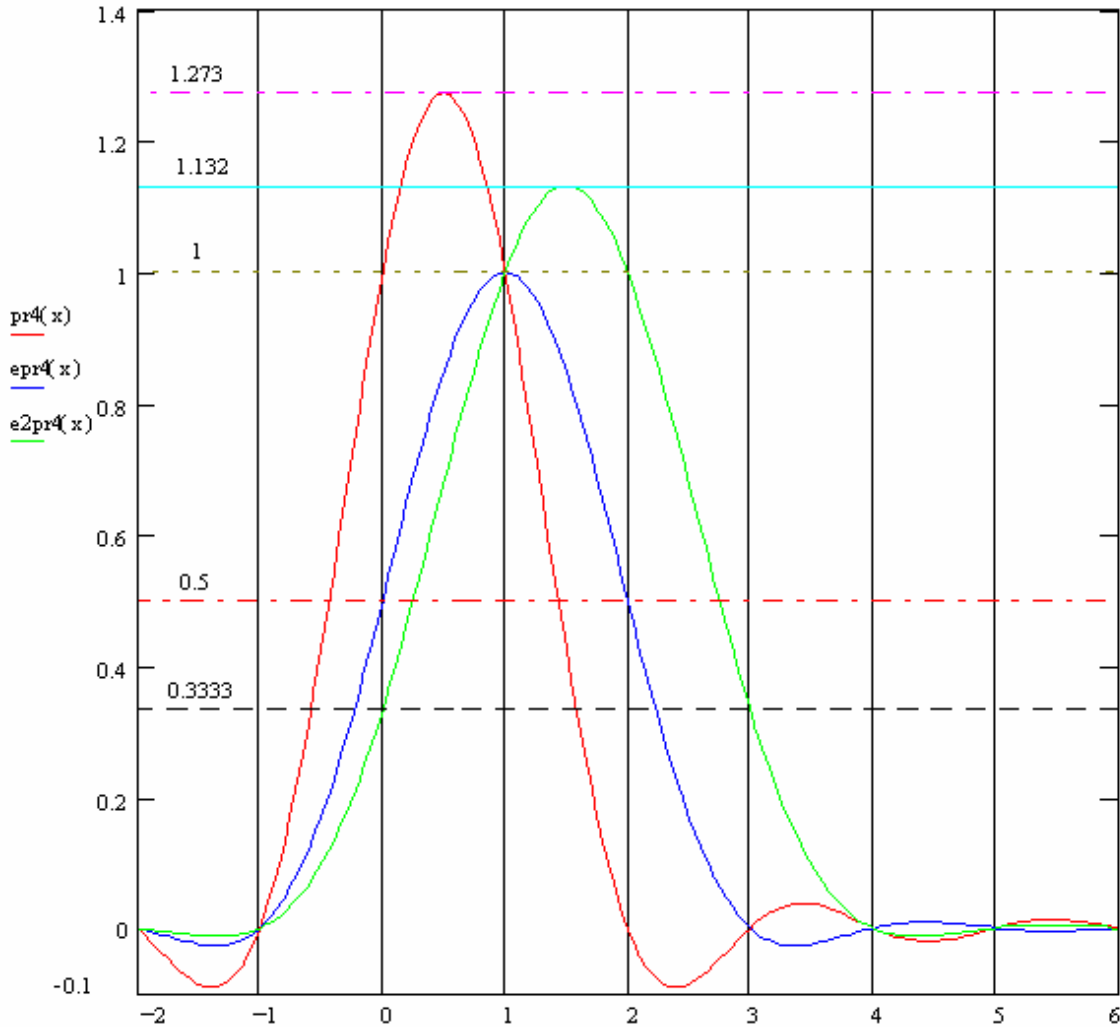

Group Delay

The delay through the filter of the lowest frequencies can be adjusted. The normal setting is 0.0% adjustment; that is, flat response. This is used to compensate for group delay distortion before the filter. Group delay setting is unaffected by **Train Filter**.

The digital implementation of our equalizing filter does not have perfectly flat group delay. The non-flatness increases with the ratio of -3 dB frequency to sampling rate and with boost. The DDA requires 5 samples per bit cell, which means that the -3 dB frequency will be 10% of sampling rate. If this requirement is met, group delay should be sufficiently flat. E2PR4 is especially sensitive to non-flat group delay. For E2PR4, especially if the "5 samples per bit cell" requirement is not met, it will probably be beneficial to set the "Group Delay" field to a small positive number, perhaps 6% or so. This helps flatten the group delay of our equalizer filter.

Resampling ADC

Because the DDA data is already digital, this simply interpolates between DDA samples to produce a digital value at the channel sample time.

Finite Impulse Response (FIR)

In addition to the continuous time analog filter (CTAF), there is normally an FIR filter following the analog-to-digital converter at the PRML channel's sample rate. Its purpose is to 'adapt' and fine-tune equalization. The DDA's 21-tap FIR has coefficients that can be set using remote commands. The tap weights can be asymmetric to minimize delay through the filter. Extra delay will reduce the stability of our control loops for sampling phase and automatic gain control.

If the coefficients as entered sum to > 1 they are renormalized to sum to 1.0; if they sum to < 0.1 as entered they are rejected. Other than that, there are no restrictions on the tap weights.

In many channel chips, the FIR equalization filter is adaptive. However, the DDA does not change the values set by the user.

Phase Locked Loop (PLL)

Correct operation of any PRML system also depends on the taking of readback signal samples at exact "focus" positions. Shifting the clock slightly from the correct position is enough to distort sample values.

A clock recovery circuit, Phase Locked Loop (PLL), adjusts the phase of the oscillator, based on the value of the phase error. This is usually done in a feedback circuit.

The phase-error function is calculated in the phase detector circuit and is equal to zero in the correct clock position. When the signal is correct, the error signal is equal to zero, and oscillator frequency and phase remain in exactly the correct position. If for some reason the phase of the input signal and that of the oscillator diverge --- owing to instability of disk rotation or noise, for example --- the phase-error signal deviates from zero, and the frequency of the oscillator shifts.

Two main problems have to be resolved in the clock recovery circuit. One is the initial fast-phase acquisition: prior to a reading of the pattern, it is necessary to align the clock to the correct position of the pattern. The other is tracking --- the following of relatively slow instabilities of the disk rotational speed. In order to avoid fast, noisy phase shifts, and to provide system stability, the phase-error signal is integrated by an integrator.

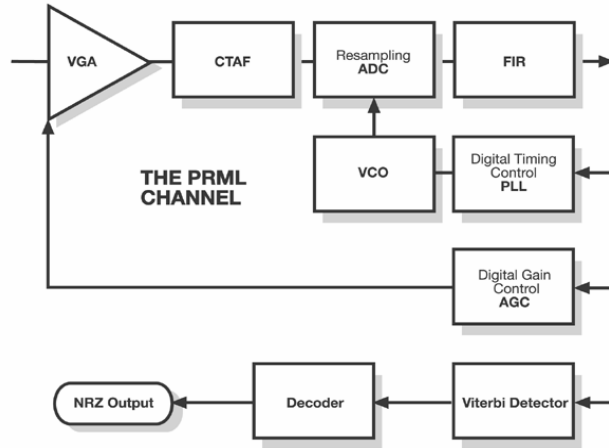

Automatic Gain Control (AGC)

The phase and gain steering algorithm in the DDA's channel emulation (AGC) will adjust for changes in the signal after VCO Synch. Read gate tells us where to start looking at the VCO Synch.

Phase is essentially the timing of when a sample is taken, while gain is the levels that are being searched for as +1 and -1. Thus, when a sample larger than the ideal value is taken, the level looked for by the emulation is increased. The screen below shows an example of phase and gain steering.

To start the AGC, we must find the maximum and minimum levels in the VCO Synch, and then initialize the levels to be searched. Thus, if the pulses are exactly the desired shape, then 1 and -1 will be where expected, with the other levels symmetrically spaced in between.

Note that the VCO Synch must exist in the acquired head signal, or the channel emulation cannot be run. The phase and gain steering algorithm in the emulation will adjust for changes in the signal after VCO Synch, assuming it starts correctly.

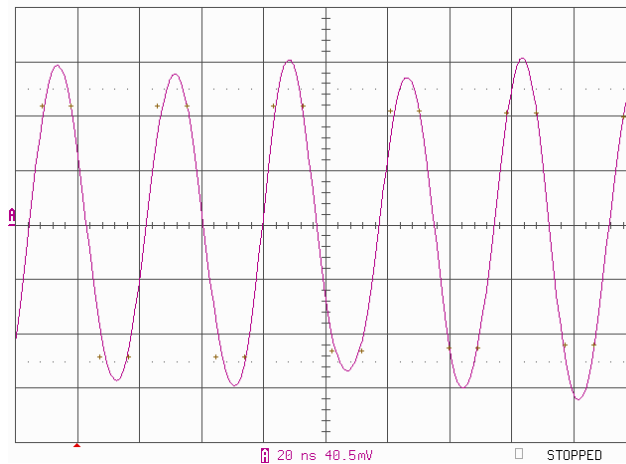

PLL and AGC

The sample, phase-steering (PLL) and gain adjust (AGC, level computation) work together, one sample at a time. They are used to compute sampled data for input to the Viterbi detector.

ML Detector

Samples on the output of the ADC ideally have a small number of levels: {1,0,+1} for the PR4 system, for example. A threshold detector could be used to classify a current sample value comparing it to an amplitude threshold. For example, if sample > 0.5, sample = 1; if sample < 0.5, sample = -1; if sample = 0.5, sample = 0.

For the sequence of samples 0.8 0.3 -0.7 -0.2 0.6 0.9 1.1 0.2, the threshold detector output would be: 1 0 -1 0 1 1 1 0.

The difficulty here is that the sequence of three ones in a row ("111") is impossible: the pulse is too wide. The only possible combinations are 011, 110, -111, and so on.

A threshold detector, such as the peak detector on a Peak-Detect drive, does not use the previous and subsequent samples. But the maximum likelihood (ML) detector "knows" that "111" is a forbidden sequence of samples and tries to determine the most probable data pattern for this sequence of samples (21 samples used for PR4).

Proposing several close allowable sequences --- {1 0 -1 0 1 1 0 0} or {1 0 -1 0 0 1 1 0} or {1 0 -1 0 0 0 1 1} --- is easy. But which is the most probable?

The decision is made based on a sequence of samples, instead of only a single, current sample, and the sequence with the minimum distance (maximum likelihood) is selected as the detection result.

Viterbi Detector & Trellis

The Viterbi detector is a state machine consisting of two distinct parts: states and transitions. While state is the current magnetization of the disk and some history (memorization of the latest states), transition relates the current state to the next state. For the detector, only two possibilities exist: either the state (medium magnetization) is the same between the current and the next bit periods or it is not.

The detector's trellis works according to this dichotomy: "0" or "1" is followed by either "0" or "1", and so on. The trellis is a mechanism that keeps track of a sequence of magnetization states. When the ML detector makes decisions, it keeps the states of several consecutive time instants and estimates the likelihood of possible "histories" (higher probability). The higher the order of the PRML system, the larger and more complex the trellis. However, some trellises do not allow certain transitions (d=1 constraint), thereby limiting the extent to which the pulses can overlap.

SAM

Sequenced Amplitude Margin (SAM) measures the error margin of every sample taken by a PRML channel chip. Determining that a written bit is either a "0" or a "1" is the disk drive's most basic decision. SAM measures the margin by which the Viterbi detector has made this decision, the margin or distance being a function of the path metrics and current sample taken together.

SAM can provide a prediction of the error rate, and can be used both for characterization and for

optimizing equalization. Lower SAM values mean worse error rates.

The range of SAM values depends on the PRML order, as does the path metrics, memory, or sequence. The range is 0 to 2.0 for a PR4 channel. The "0" in this case signifies that the drive had no margin to make the decision, that it could have read every single bit wrongly, and that at 2.0 the drive had as much margin as it could and will never make an error.

The distribution of SAM values will always center on the square of the minimum distance to an error, i.e., 2.0 for PR4; 1.0 for EPR4 (these numbers are correct when the signal amplitude is normalized, so sample values are -1 to +1). The width of the distribution is narrow for clean signals, broader for noisy signals. Mismatched signals have broad, multi-peaked distributions. When the tail of this distribution crosses zero, it means an error has been made. This can only be determined with certainty if the correct decode (the correct path through the trellis) is known.

Encoding

Both Peak-Detect and PRML read channels use Run-Length Limited (RLL) coding. This corresponds to the only part of the channel chip that the DDA does not simulate: that between the Viterbi detector and the NRZ lines at the output of the chip.

RLL codes impose constraints on the data written to the disk by limiting the minimum and maximum number of 0's that must come between each pair of 1's in the encoded pattern written to the disk (head/analog signal). The limitation on the minimum number of "0"s provides transition separation to avoid pulse crowding. RLL codes are characterized by four parameters, referenced as (m/n)(d/k):

- modulation code maps m user bits (NRZ data) into n encoded bits (head/analog signal)
- n is always bigger than m , because n smaller than m would mean data is compressed on the disk; Code Rate = m/n
- d equals the minimum number of 0's between two consecutive 1's
- k equals the maximum number of 0's between two 1's

The DDA does not implement interleaved ML detection, therefore it does not check even and odd sample streams separately for this limit. However, when the constraints are specified as (d, k1, k2), one can sum k1 and k2 and use that where k is needed. This allows a series of non-transitions long enough to unquestionably be an error to be reported as an error. However, it will not catch all the sequences that would be an RLL violation for interleaved detection.

Error Correction

Prior to the RLL encoding, the user data is normally encoded inside the drive's microcontroller, using special error-correction codes (ECC). Thus, there are two levels of encoding.

User Defined Trellis

File Format and Language (version 1)

This feature allows you to define the trellis used by the Viterbi detector in the LeCroy DDA's channel emulation. The file specifies the target levels and all possible transitions. You can also specify many significant aspects of our emulated channel, including the proportional (phase) and integral (period) gain on the clock steering control loop, the AGC gain, adjustment limits, etc. This permits

you to define how the signal will be handled by the emulated channel, as well as the trellis used in the Viterbi detector.

The User Definition file is a plain ASCII text file. Such a file can be made with Windows Notepad or any text editor, or by any word processor with a "Save As Text" capability. The file may have any name in 8.3 format (i.e., DOS file name). Our example uses the extension ".UDF", but it is not required. A User Definition file can be loaded from floppy disk or hard disk (the hard disk is optional).

The first characters in the file must be **USER DEFINED VITERBI TRELIS FOR LECROY DDA**. If the string **USER DEFINED VITERBI TRELIS FOR LECROY DDA** is not seen at the start of the file, the file is not parsed, and any previously loaded user definition is left undisturbed. The message "Header not found at start of file - read aborted" is displayed.

The rest of this Help file defines the keywords that can appear and the arguments they take. An example file follows. In all cases, if an argument is outside limits, or a stated order dependency is violated, an informative error message is displayed and the parse is canceled. The error message will persist on the screen until replaced. If a user definition is successfully loaded, a confirming message is displayed. The message disappears after approximately 10 seconds.

Loading Your UDT File Remotely

To call the UDT file when operating the instrument remotely, use remote command

```
DD_LOAD_UDF "filename"
```

where:

filename = full qualified path to the UDT file, for example, "C:\Lecroy\myudf"

General Rules and Error Messages

All lexical elements should be separated by white space. Lexical elements include keywords and their arguments. White space includes space, tab, carriage return, and line feed. One exception: the double slash //, which starts a comment, need not be followed by white space.

As the file is parsed, if the expected number of arguments for a keyword is not available, the error message "Could not read args for '<keyword>..! abort" will be displayed and the parse is canceled. If the word where we expect a keyword is not recognized as a keyword, the error message "Word starting '<text>': not a keyword! Abort" is displayed and the parse is canceled. Possible causes for this are comment text without a preceding //, or too many arguments for the preceding keyword.

When the end of the file is reached, the DDA verifies that all required keywords were seen in the file. If not, the message "Missing <number> required keywords!" is displayed and the parse is considered canceled. Not all keywords are required; however, we strongly encourage you to use them all, in every file. The result of omitting most optional keywords is to leave previously set values unchanged.

Keywords

keyword:	//
arguments:	none
required?:	no
	Notes: 1. // begins a comment. After // the rest of the line, up to line feed, is ignored. 2. // need not be followed by a space.

keyword:	AGC_GAIN
arguments:	<value, 0 to 0.125>
required?:	no
	Notes: The difference of the normalized (-1 to +1) sample value to the expected sample value is multiplied by this to determine the change in expected level. The DDA treats positive and negative levels separately, to handle asymmetric waveforms. The change in the 0 level is 1/4 of this, a correction to the 0 level shifts all the levels. The DDA also allows very slow changes of relative spacing; it starts analyzing each VCO sync field assuming symmetry and perfect spacing. In the DDA, this value is 0.12 for PR4, EPR4, and E2PR4. If this keyword is not seen, its value remains unchanged. If this value is never set, the default is 0.12.
possible error messages:	"AGC_GAIN must be >= 0 and <= 0.125"

keyword:	KEYWORDS_VERSION
arguments:	1
required?:	yes
possible error messages:	"Keywords version is newer than software rev!" When the keywords file is updated, this message will specify KEYWORDS_VERSION 2. New software will be able to handle versions 1 and 2. Old software will produce this error message if it encounters KEYWORDS_VERSION 2.

keyword:	LEVELS
arguments:	<number from 3 to 32>
required?:	yes
	Note: LEVELS must appear before NORMALIZED_LEVELS are specified
possible error messages:	"#levels must be >= 3 and <= 32!"

keyword:	MAX_LEVEL_ADJ
arguments:	<value from 0.0 to 1.0>
required?:	no Notes: This sets a hard limit on the maximum change in an expected level due to steering from one sample. Setting this value to 1.0, or near that value, makes the limit irrelevant. The DDA uses 0.0625 for PR4, 0.03125 for EPR4, and 0.020833 for E2PR4. If this keyword is not seen, its value remains unchanged. If this value is never set, the default is 0.020833.
possible error messages:	"MAX_LEVEL_ADJ must be >= 0 and <= 1.0"

keyword:	MAX_PHASE_ADJ
arguments:	<value 0 to 0.1>
required?:	no Notes: This sets a hard limit on the maximum phase change (and the maximum period change) of the emulated PLL due to steering from one sample. The value is a fraction of a bit cell time. The DDA uses 0.06 for PR4 and EPR4, and 0.04 for E2PR4. If this keyword is not seen, its value remains unchanged. If this value is never set, the default is 0.04.
possible error messages:	"MAX_PHASE_ADJ must be >=0 and <=0.1 (bit cells)"

keyword:	NORMALIZED_LEVELS
arguments:	(see note below)
required?:	no Notes: 1. This keyword takes LEVELS arguments, each a value from -1 to 1, in order. 2. If this keyword is not supplied, levels default to LEVELS: equally spaced values from -1 to 1. 3. LEVELS must be seen before this keyword.
possible error messages:	"Must set #levels before specifying levels!" "Must set TOP_LEVEL... before specifying levels!" "Normalized levels must be in order, -1 to 1!" "Normalized levels must be -1 to 1!"- arguments didn't include -1 or 1, or both

keyword:	PLL_INTEG_GAIN
arguments:	<value 0 to 1e-10>
required?:	no Notes: The value is multiplied by a code difference from the expected level times slope. The result is to produce a period correction as a fraction of bit cell time. The DDA uses 4e-11 for PR4, EPR4 and E2PR4. If this keyword is not seen its value remains unchanged. If it has never been set since power on the default is 4e-11. See notes for PLL_PROP_GAIN above.
possible error messages:	"PLL_INTEG_GAIN must be >= 0 and <= 1e-10"

keyword:	PLL_PROP_GAIN
arguments:	<value 0 to 1e-8>
required?:	no Notes: The value is multiplied by a code difference from the expected level times slope normalized to codes/bit cell near the sample. The result is to produce a phase correction as a fraction of a bit cell time. The phase error tends to have a significant random component so this value should be kept low. The DDA uses 5e-9 for PR4, 2e-9 for EPR4 and 1e-9 for E2PR4. If this keyword is not seen, its value remains unchanged. If it has never been set since power on, the default is 1e-9. Notes about the PLL loop: We steer our software PLLs phase (proportional) and period (integral) with coefficients phase_steering_gain and spacing_steering_gain. They are used like this: spacing correction = phase error * spacing_steering_gain phase correction = phase error * phase_steering_gain where: phase error = distance from sample to level * slope * scope samples per bit cell Notes: 1. Distance is normalized (-7200 = -1 level, +7200 = +1 level) 2. Slope is (normalized codes/scope sample) around the channel sample position 3. Multiplying by samples per bit cell normalizes for scope sample rate: slope (codes/scope sample) is cut in half when sample rate doubles codes/scope sample * scope sample/bit cell = codes/bit cell The gain terms must be small enough so that the correction is mostly uncompleted within the latency (STEERING_LATENCY + FIR delay) of the control loop. Otherwise the loop will be unstable. The spacing and phase corrections are in fractions of a bit cell.
possible error messages:	"PLL_PROP_GAIN must be >= 0 and <= 1e-8"

keyword:	STATE
arguments:	<p><which state> 0 to STATES minus 1</p> <p><previous state from 0> 0 to STATES minus 1 (or 100, see below)</p> <p><expected sample level from 0> -1 to 1</p> <p><previous state from 1> 0 to STATES minus 1 (or 100, see below)</p> <p><expected sample level from 1> -1 to 1</p>
required?:	<p>yes</p> <p>Notes:</p> <ol style="list-style-type: none"> 1. The states are specified in NRZ (nonreturn to zero) format, that is 0 and 1 are the two polarities of magnetization. On the head signal (the first sample of) a negative going pulse begins a "0" polarity region on the media, and a positive going pulse begins a "1" polarity region. "from 0" means the bit cell which is no longer part of the state was 0 polarity. Consider the state 0011. If the preceding state was 0001 then the state 0011 was arrived at along the "from 0" transition. Similarly if the preceding state was 1001 then the state 0011 was arrived at along the "from 1" transition. 2. At least one STATE specification must be seen or the parse is considered failed. 3. In some cases one (or both) of the transitions to a state may not be valid, that is, they are disallowed due to encoding constraints. In such a case use the value 100 as the "previous state from" for that transition, this is recognized as disallowing the transition. Any other value outside of 0 to STATES minus one is declared a parse error. If both transitions to a state are disallowed, the state cannot be arrived at; it is invalid. You need not specify invalid states (states that cannot be arrived at). For proper operation you must specify every state that can be arrived at. 4. The STATES keyword, specifying the number of states, must be seen before a STATE can be specified.
possible error messages:	<p>"Must set #states before STATE info!" - see note 4 above.</p> <p>"State <number>?? Expected states 0 to <STATES - 1>!"</p> <p>"State <number>: must be -1 < expected level < 1!"</p>

keyword:	STATES
arguments:	<number from 4 to 16>
required?:	<p>yes</p> <p>Note: STATES must appear before a STATE is specified</p>
possible error messages:	"#states must be >= 4 and <= 16!"

keyword:	STEERING_LATENCY
arguments:	<value 0 to 10>
required?:	no Notes: The DDA's channel emulation uses decision directed steering. This means that the PLL and AGC are not determined based on the nearest level to each sample. Instead, we wait STEERING_LATENCY samples and then steer based on what the sample should have been according to the Viterbi detector. The DDA uses 6 for PR4, EPR4, and E2PR4. After 6 samples it is far more likely that the detector has already picked the correct path, and we will steer toward the correct target. If this keyword is not seen, its value remains unchanged. If it has never been set since power on, the default is 6. CAUTION: Increasing the steering latency increases the delay for the steering control loops and may make them unstable. For a 16 state signal (such as E2PR4), the detector uses the sample at STEERING_LATENCY into the trellis, and four more preceding it (that is, further into the trellis) to determine the expected value for the sample at STEERING_LATENCY. The difference between the actual sample value and the expected value determines steering.
possible error messages:	"STEERING_LATENCY must be >= 0 and <=10"

keyword:	TOP_LEVEL_AS_FRACTION_OF_PEAK
arguments:	<number, 0.5 to 1.5>
required?:	yes Notes: This is the ratio of the nominal "1" sample level to the peak height of the VCO sync pattern. This is used in our emulated channel's acquisition of the proper sampling phase and levels. For example, using a 2T sync pattern, PR4 has levels +1, +1, -1, -1 & and the peaks are significantly higher. For PR4, the DDA uses 0.7854 for this value. For EPR4, a 2T pattern is 0, +1, 0, -1& so the peaks are +1 and -1. For EPR4 the DDA uses 1.0000 for this value. For E2PR4 a 2T pattern is +0.6667, +0.6667, -0.6667, -0.6667, and the peaks are higher, slightly above the +1 level. For E2PR4 the DDA uses 1.06045 for this value.
possible error messages:	"top level must be > 0.5 and <= 1.50 x sync peak"

keyword:	TRELLIS_LENGTH
arguments:	<value 11 to 81>
required?:	no Notes: Because of internal implementation constraints, the trellis cannot be 28 to 32 long, or 60 to 64 long. An attempt to set it within those ranges will be accepted but will actually set the next larger permitted value, that is, 33 or 65. If this keyword is not seen its value remains unchanged. If this value is never set the default is 81. Longer trellis size does not noticeably slow down processing. Longer trellis size approaches true maximum likelihood to greater certainty. Real disk channels tend to have short trellises and rely on encoding to avoid sequences that would require a longer trellis to resolve. On a good signal all possible paths being maintained in the trellis are the same beyond a few bits in, the vast majority of the time.

possible error messages:	"TRELLIS_LENGTH must be ≥ 11 and ≤ 81 "
---------------------------------	---

keyword:	ZERO_CROSS_TO_SAMPLE
arguments:	<value 0 to 0.5>
required?:	yes Notes: This tells the DDA how the correct sampling times relate to zero crossings during the VCO synchronization preamble. The value is a fraction of the spacing between zero crossings. Example: The VCO synch is normally a 2T pattern. For PR4 the samples are 1, 1, -1, -1; there are two samples between zero crossings, and the first sample after a zero crossing is one quarter of the distance to the next zero crossing. Therefore ZERO_CROSS_TO_SAMPLE is 0.25 for PR4. For EPR4, a 2T pattern gives samples 0,1,0,-1; the first sample is at the zero crossing; therefore, ZERO_CROSS_TO_SAMPLE is 0 for EPR4. For E2PR4, a 2T pattern gives 2/3, 2/3, -2/3, -2/3; there are two samples between zero crossings, and the first sample after a zero crossing is one quarter of the distance to the next zero cross, just as for PR4. Therefore ZERO_CROSS_TO_SAMPLE is 0.25 for E2PR4.
possible error messages:	"ZERO_CROSS_TO_SAMPLE must be ≥ 0 and ≤ 0.5 "

Example File

An example of a user definition equivalent to E2PR4 (d=0) follows. This file was named E2PR4.UDF:

```
USER DEFINED VITERBI TRELLIS FOR LECROY DDA // a comment can go here
// The above line is required exactly as shown or the file will be rejected!
KEYWORDS_VERSION 1
STATES 16
// State initializers - one for each valid state
// state prev from 0 level prev from 1 level
STATE 0 0 0 8 -0.33333
STATE 1 0 0.33333 8 0
STATE 2 1 0.66667 9 0.33333
STATE 3 1 1 9 0.66667
STATE 4 2 0 10 -0.33333
STATE 5 2 0.33333 10 0
STATE 6 3 0.66667 11 0.33333
STATE 7 3 1 11 0.66667
```



```
STATE 8 4 -0.66667 12 -1
STATE 9 4 -0.33333 12 -0.66667
STATE 10 5 0 13 -0.33333
STATE 11 5 0.33333 13 0
STATE 12 6 -0.66667 14 -1
STATE 13 6 -0.33333 14 -0.66667
STATE 14 7 0 15 -0.33333
STATE 15 7 0.33333 15 0

LEVELS 7

TOP_LEVEL_AS_FRACTION_OF_PEAK 1.06045 // nominal 1 / peak height in vco sync
field. For 2T

NORMALIZED_LEVELS -1 -.66667 -.33333 0 .33333 .66667 1

PLL_PROP_GAIN 1e-9

PLL_INTEG_GAIN 4e-11

MAX_PHASE_ADJ 0.04

STEERING_LATENCY 6

TRELLIS_LENGTH 81

AGC_GAIN 0.12

MAX_LEVEL_ADJ 20.833e-3

ZERO_CROSS_TO_SAMPLE 0.25 // Fraction of zero cross spacing

// End of file
```

§ § §